

DESIGNER INFORMATION

Special details for entrances other than Cases 1 and 2 are included in the detail plans. The shape and surface of driveways and alleys will vary to fit individual conditions.

Use unreinforced concrete pavement mix with a minimum thickness of 6 inches, unless specified otherwise for driveways and alleys. If an alley drains toward the roadway, use a 2 inch inverted crown; otherwise, use flat surface for driveway pavement.

W is measured at the street side of sidewalk. If sidewalk is not present, *W* is to be measured at the end of the returns for Case 1 and 10 feet back of curb for Case 2.

- ① Transverse Pavement Joints as per detail Project Plans.
- ② 'K' Pavement Joint (Refer to **PV-101**) from end of radius to end of radius.
- ③ Line at the Back of Curb.
- ④ 'C' Joint on Centerline.
- ⑦ Refer to contract documents for sidewalk construction if the entrance is designed to accommodate sidewalk. Construct sidewalk using the same thickness as the driveway.
- ⑧ If the sidewalk is in place at the time of construction, place 'E' Joint along the front edge of the sidewalk. If the sidewalk is reconstructed with the driveway entrance, place 'E' Joint along the back edge of the sidewalk and a 'C' Joint sawed or formed along the front edge of the sidewalk. Refer to **PV-101** for joint details.
- ⑩ Maximum cross slope is 2% unless specified otherwise in the contract documents.
- ⑪ If cross slope of the sidewalk panel exceeds 2%, remove and replace to transition from existing sidewalk to sidewalk through driveway. If elevation change requires a curb ramp, comply with **MI-220**; verify need for detectable warning panel with Engineer.

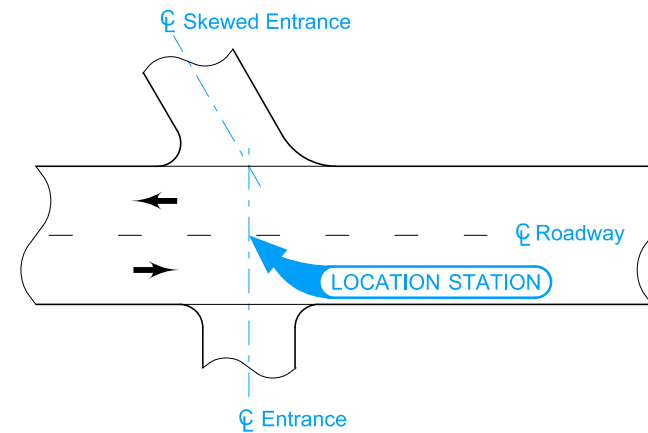

ENTRANCE LOCATION

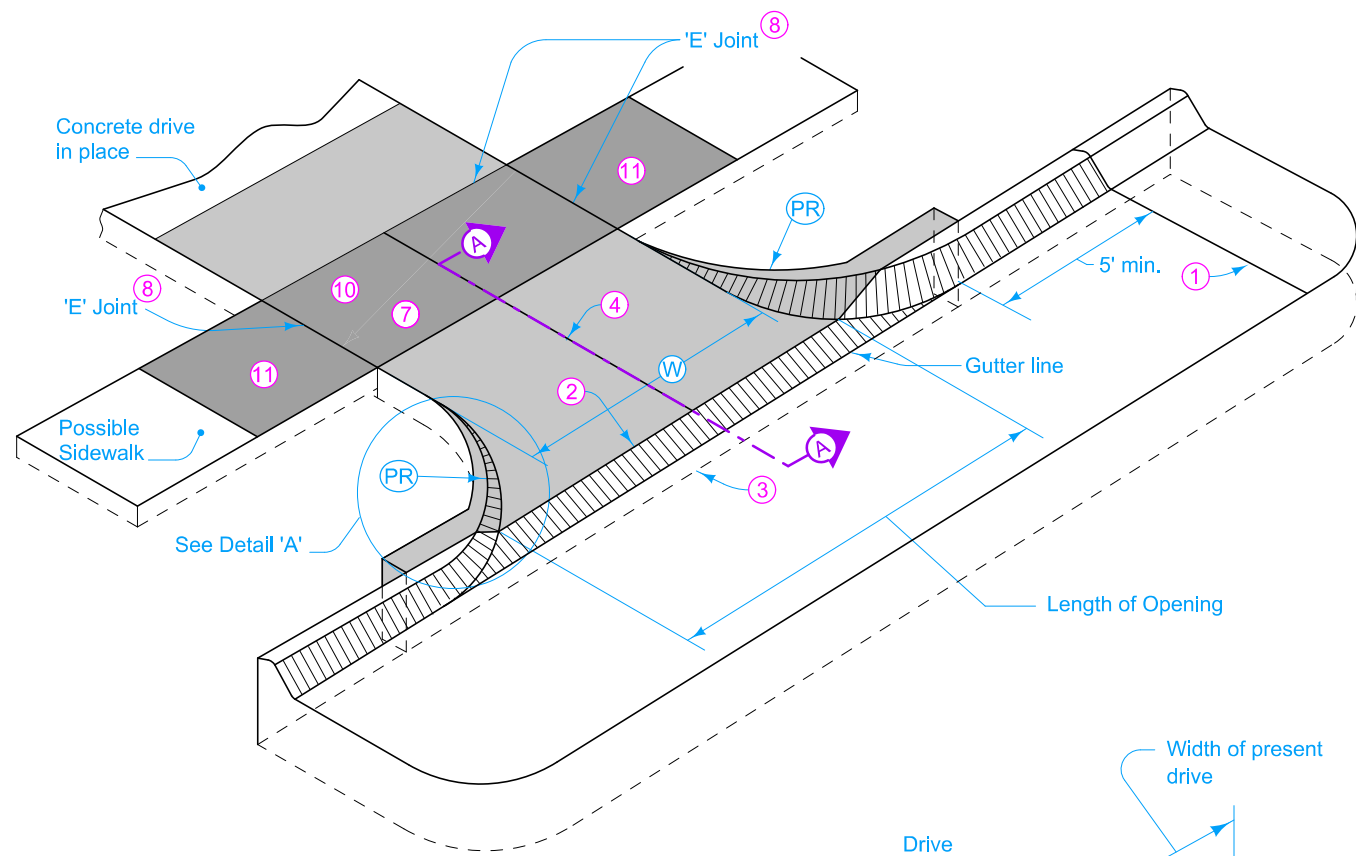

CASE 1 ENTRANCE

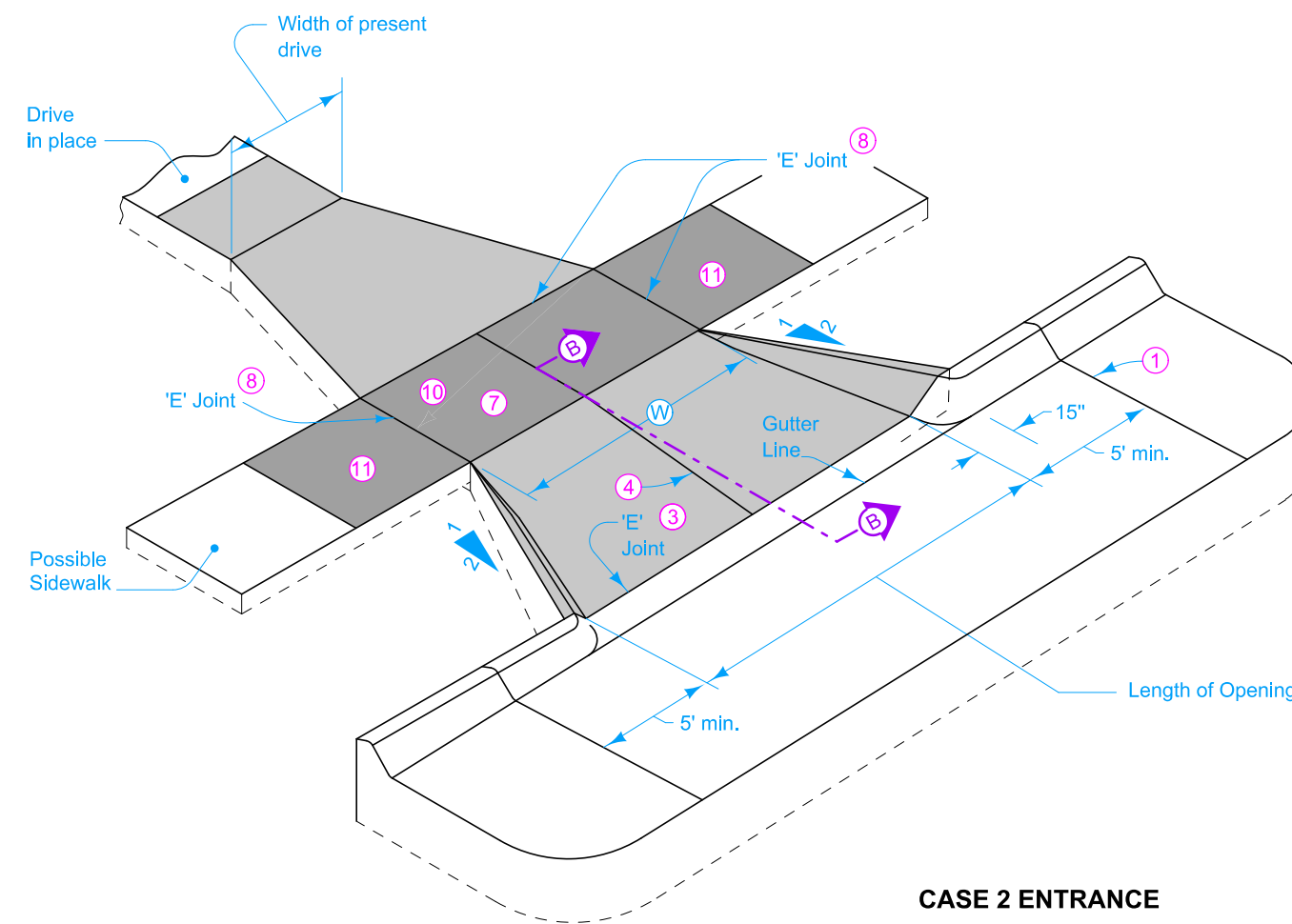

CASE 2 ENTRANCE

Possible Contract Items:
 Driveway, P.C. Concrete
 Driveway, Reinforced P.C. Concrete
 Removal of Paved Driveway
 Sidewalk, P.C. Concrete

Possible Tabulation:
 102-3

	REVISION	
	6	10-20-15
STANDARD ROAD PLAN		MI-210
		SHEET 1 of 2

REVISIONS: Replaced the DOT logo in the title block with the new version.

Shawn Miller
 APPROVED BY DESIGN METHODS ENGINEER

PCC DRIVEWAYS AND ALLEYS

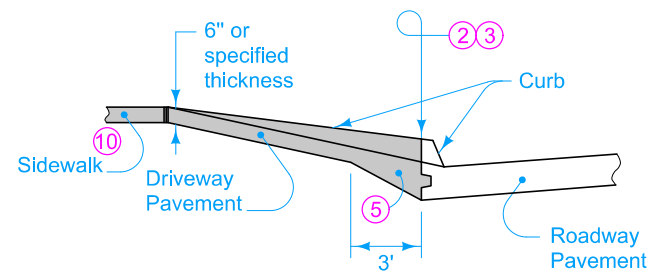

**SECTION A-A
(Case 1 Entrance)**

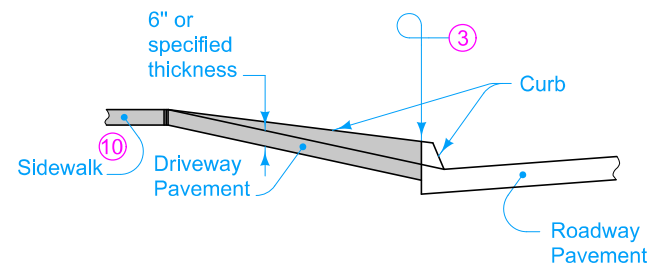

**SECTION B-B
(Cases 2 Entrance)**

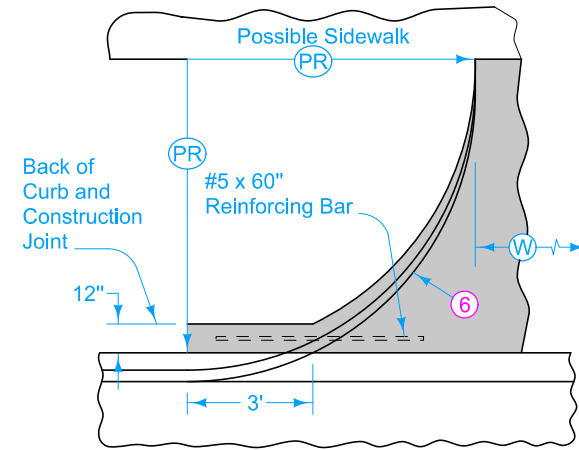

**DETAIL 'A'
CASE 1 ENTRANCE**

- ② 'K' Pavement Joint (Refer to PV-101) from end of radius to end of radius.
- ③ Line at the Back of Curb.
- ⑤ Taper to Pavement Thickness.
- ⑥ Lip curb varies from either 4½ inch or 3 inch at back of curb to 0 inch at front of sidewalk.
- ⑨ Refer to Tabulation 102-3.
- ⑩ Maximum cross slope is 2% unless specified otherwise in the contract documents.

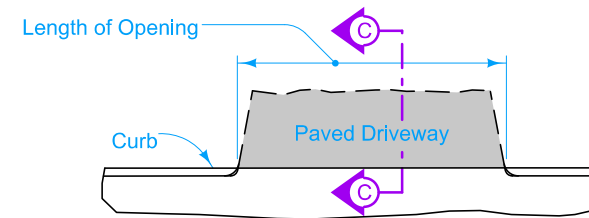

PLAN

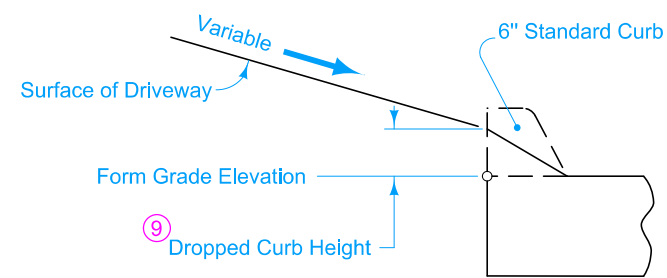

**SECTION C-C
(Standard Curb)**

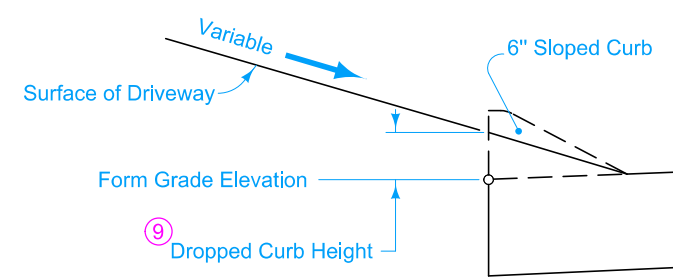

**SECTION C-C
(Sloped Curb)**

DROPPED CURB

	REVISION	
	6	10-20-15
STANDARD ROAD PLAN		MI-210
		SHEET 2 of 2

REVISIONS: Replaced the DOT logo in the title block with the new version.

Shawn Miller
APPROVED BY DESIGN METHODS ENGINEER

PCC DRIVEWAYS AND ALLEYS