

SHOULDERS

6 LANE

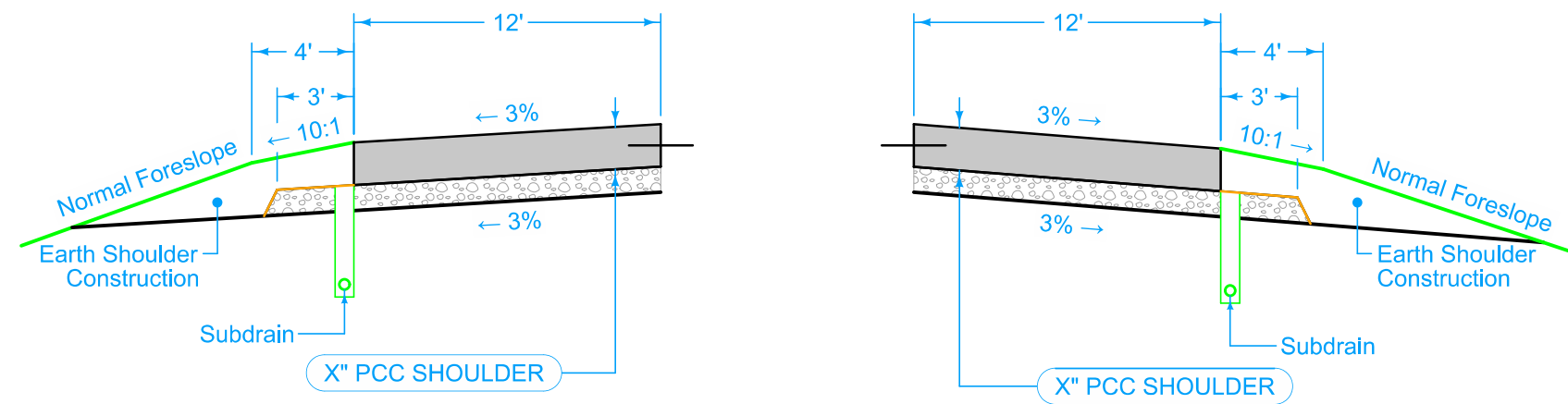

Full Depth PCC Shoulder

Shoulder Jointing:
 Longitudinal joint: BT-2, or L-2
 Transverse joints: C at 17' spacing

6D_Dprs_P_FullPCC_ 04-15-25		
Direction of Travel	BEGIN STATION	END STATION