

PART PLAN VIEW

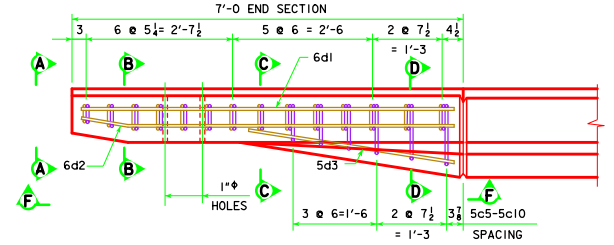

PART VIEW E-E

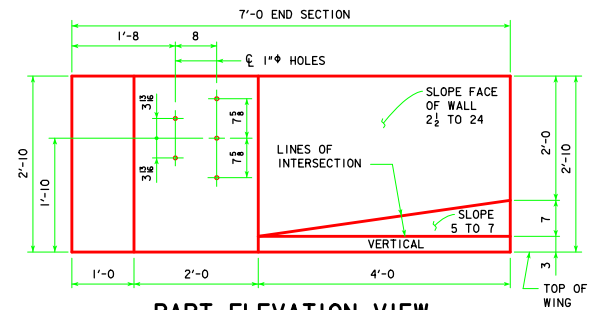

PART ELEVATION VIEW

PROVIDE 5 HOLES FORMED WITH 1" PLASTIC CONDUIT. COST TO BE INCLUDED IN PRICE BID FOR CONCRETE BARRIER RAILING.

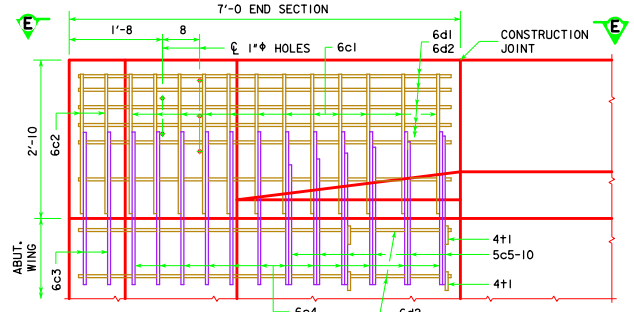

PART VIEW F-F

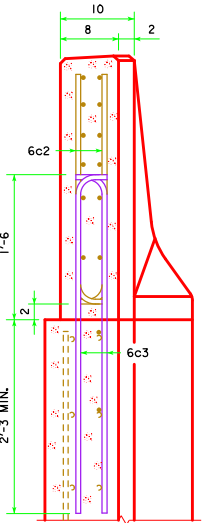

VIEW A-A

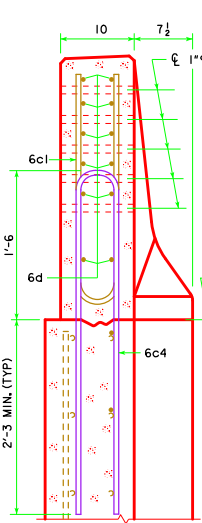

SECTION B-B

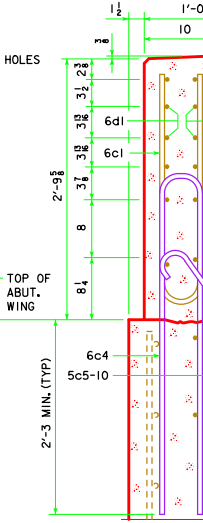

SECTION C-C

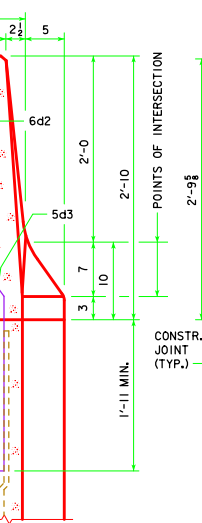

SECTION D-D

NOTE: 4+1 PLACEMENT - 2 BARS EACH LEVEL OF 6d2 IN WING FOOTING.

NOTE: CONSTRUCTION JOINT BETWEEN TOP OF WING AND BARRIER RAIL IS ROUGHENED CONCRETE.

NOTE: THE 10" RADIUS AND 1 1/2" RADIUS ARE TYPICAL AND SHALL BE USED WHEN CONSTRUCTING THE CORNERS FOR VIEW A-A, SECTION B-B, SECTION C-C AND SECTION D-D.

NOTE: THE 6c4, 6c3, 5c5-10, 2 - 6d2 & 4+1 BARS ARE TO BE PLACED WITH THE ABUTMENT WING. THE DETAILS FOR PLACEMENT ARE SHOWN ON THE WING ABUTMENT SHEET.

NOTE: DASHED LINES BELOW THE TOP OF WING ARE THE ABUTMENT WING REINFORCING STEEL. SEE WING ABUTMENT SHEET FOR PLACEMENT.

EPOXY REINFORCING STEEL - ONE END SECTION

BAR	LOCATION	SHAPE	NO.	LENGTH	WEIGHT
6c1	VERTICAL	□	12	5'-6	99
6c2	VERTICAL	┘	4	2'-10	17
6d1	HORIZONTAL	—	6	6'-8	60
6d2	HORIZONTAL	—	8	6'-9	81
5d3	HORIZONTAL	—	1	3'-9	4
4+1	ABUTMENT WING TIE BARS	┘	4	VARIES	5
EPOXY COATED TOTAL WEIGHT (LBS.)					266

STAINLESS REINFORCING STEEL - ONE END SECTION

BAR	LOCATION	SHAPE	NO.	LENGTH	WEIGHT
6c3	VERTICAL	┘	4	4'-1	25
6c4	VERTICAL	┘	12	8'-0	144
5c5-10	VERTICAL	┘	6	VARIES	23
STAINLESS STEEL TOTAL WEIGHT (LBS.)					192

NOTE: REINFORCING STEEL QUANTITIES ARE TO BE INCLUDED ON THE SUMMARY QUANTITIES SHEET IN THE PLAN.

CONCRETE PLACEMENT SUMMARY

SECTION	TOTAL
BARRIER RAIL ONE END SECTION	0.65 CU. YD.

BENT BAR DETAILS

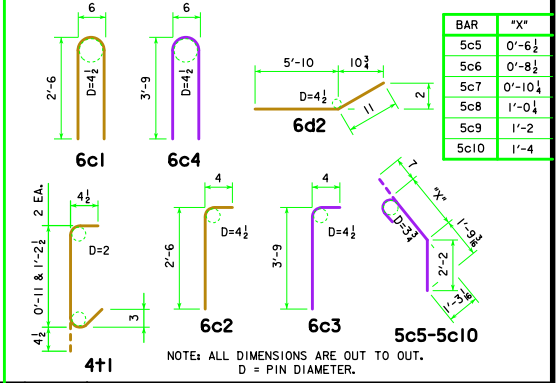

ROLLED STEEL BEAM BRIDGES

STANDARD DESIGN - 40' ROADWAY, 3 SPAN BRIDGES

OCTOBER, 2014

BARRIER RAIL DETAILS END SECTION

RS40-089-14

LATEST REVISION DATE
Thomas E. McQuinn
 APPROVED BY BRIDGE ENGINEER