

'B' ⑤
PLAIN JOINT
(Abutting Pavement Slabs)

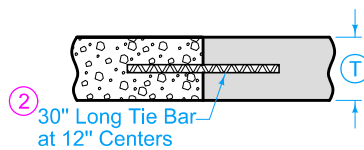

② 30" Long Tie Bar
at 12" Centers
'DW' ③ ④ ⑦
DAY'S WORK JOINT(Non-working)

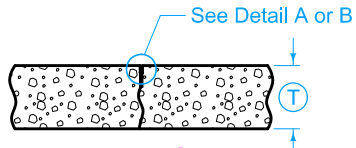

'C' ⑥
CONTRACTION JOINT

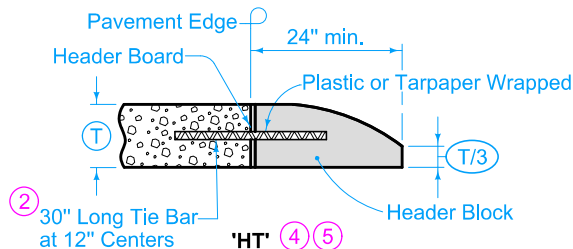

Pavement Edge
Header Board
24" min.
Plastic or Tarpaper Wrapped
② 30" Long Tie Bar
at 12" Centers
'HT' ④ ⑤
HEADER JOINT
(End Rigid Pavement)
Header Block
T/3

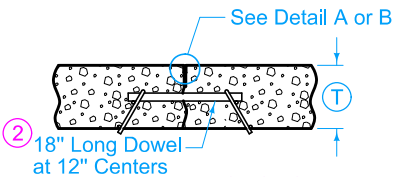

② 18" Long Dowel
at 12" Centers
'CD' ① ④ ⑥
DOWELED CONTRACTION JOINT

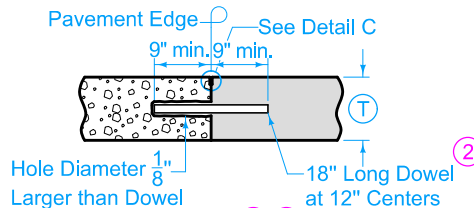

Pavement Edge
See Detail C
9" min. 9" min.
②
Hole Diameter $\frac{1}{8}$ "
Larger than Dowel
'RD' ④ ⑤
ABUTTING PAVEMENT JOINT
18" Long Dowel
at 12" Centers

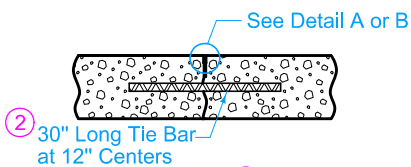

② 30" Long Tie Bar
at 12" Centers
'CT' ④
TIED CONTRACTION JOINT

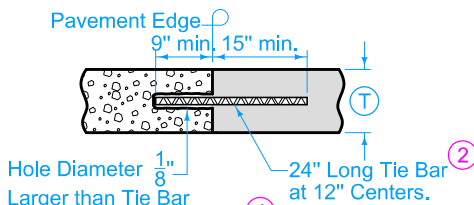

Pavement Edge
9" min. 15" min.
②
Hole Diameter $\frac{1}{8}$ "
Larger than Tie Bar
'RT' ④
**ABUTTING PAVEMENT JOINT
RIGID TIE**
24" Long Tie Bar
at 12" Centers.

- ① See dowel assemblies for fabrication details.
- ② See Bar Size Table for Contraction Joints on Sheet 2.
- ③ Locate 'DW' joint at a mid-panel location between future 'C' or 'CD' joints. Place no closer than 5 feet to a 'C' or 'CD' joint.
- ④ Place bars within the limits shown under dowel assemblies.
- ⑤ Edge with 1/8 inch tool for length of joint. For HT joint, remove header block and board when second slab is placed.
- ⑥ Unless specified otherwise, use 'CD' transverse contraction joints in mainline pavement when T is greater or equal to 8 inches. Use 'C' joints when T is less than 8 inches.
- ⑦ 'RT' joint may be used in lieu of 'DW' joint at the end of the days work. Remove any pavement damaged due to the drilling at no additional cost to the Contracting Authority.

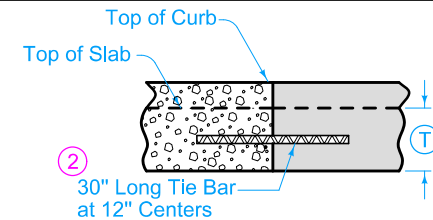

Top of Curb
Top of Slab
② 30" Long Tie Bar
at 12" Centers
'DW - CG' ③ ④
**DAY'S WORK JOINT
CURB AND GUTTER UNIT**

LEGEND	
	Existing Pavement
	Proposed Pavement

		REVISION
		10 04-21-20
FIGURE 7010.101	STANDARD ROAD PLAN	PV-101
		SHEET 1 of 8

REVISIONS: Modified Dowel Assemblies on Sheets 6 and 7 to all in-state reference to 14' pavements.

Paul D. Wiegand
SUDAS DIRECTOR

Stuart Miller
DESIGN METHODS ENGINEER

JOINTS

TRANSVERSE CONTRACTION

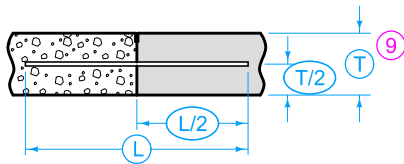

BAR PLACEMENT

(Applies to all joints unless otherwise detailed.)

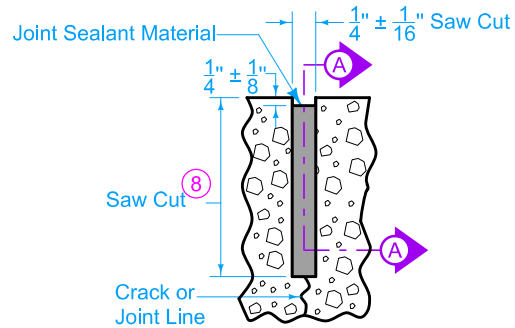

DETAIL A

(Saw cut formed by conventional concrete sawing equipment.)

- ⑧ Saw 'CD' joint to a depth of $T/3 \pm 1/4"$; saw 'C' joint to a depth of $T/4 \pm 1/4"$.
- ⑨ When tying into old pavement, T represents the depth of sound PCC.

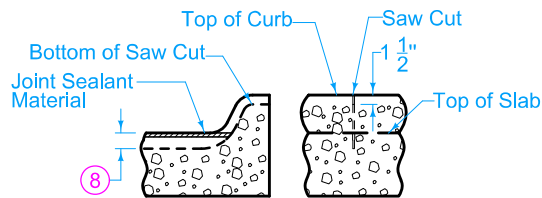

'C' JOINT IN CURB

(Match 'CT', 'CD', or 'C' joint in pavement.)

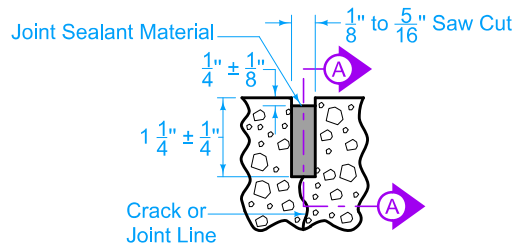

DETAIL B

(Saw cut formed by approved early concrete sawing equipment.)

BAR SIZE TABLE FOR CONTRACTION JOINTS			
T	Solid Dowel Diameter	Tubular Dowel Diameter	Tie Bar Size
$< 8"$	$\frac{3}{4}"$	$\frac{7}{8}"$	#6
$\geq 8"$ but $< 10"$	$1 \frac{1}{4}"$	$1 \frac{3}{8}"$	#10
$\geq 10"$	$1 \frac{1}{2}"$	$1 \frac{5}{8}"$	#11

Tubular Dowel Bars will not be allowed for RD joints.

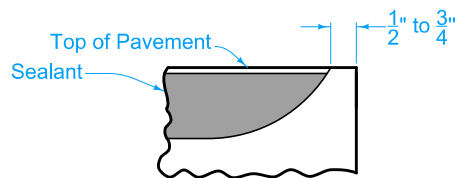

SECTION A-A

(Detail at Edge of Pavement)

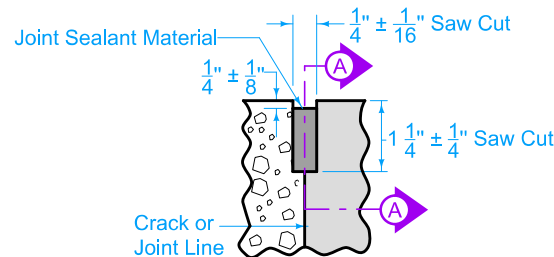

DETAIL C

LEGEND

	Existing Pavement
	Proposed Pavement

SUDAS	IOWADOT	REVISION
		10 04-21-20
FIGURE 7010.101	STANDARD ROAD PLAN	PV-101
		SHEET 2 of 8

REVISIONS: Modified Dowel Assemblies on Sheets 6 and 7 to eliminate reference to 14' pavements.

Paul D. Wigand SUDAS DIRECTOR *Steve Miller* DESIGN METHODS ENGINEER

JOINTS

TRANSVERSE CONTRACTION

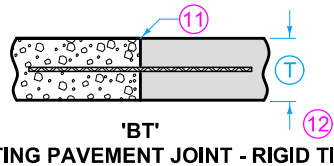
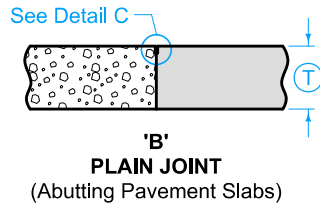

(T)	Joint	Bars	Bar Length and Spacing
< 8"	'BT-1'	#4	36" Long at 30" Centers
		#5	30" Long at 30" Centers
≥ 8"	'BT-2'	#5	36" Long at 30" Centers

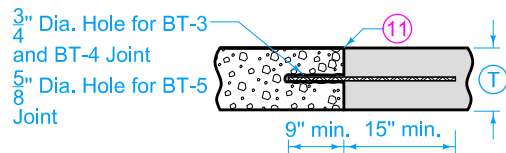

(T)	Joint	Bars	Bar Length and Spacing
< 8"	'BT-5'	#4	24" Long at 30" Centers
		#5	24" Long at 30" Centers
≥ 8"	'BT-3'	#5	24" Long at 30" Centers
	'BT-4'	#5	24" Long at 15" Centers

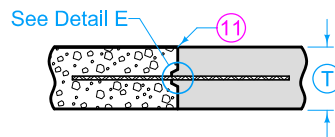
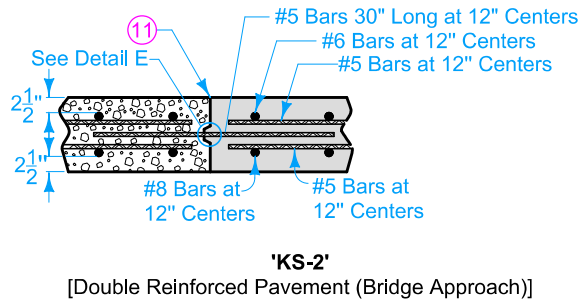
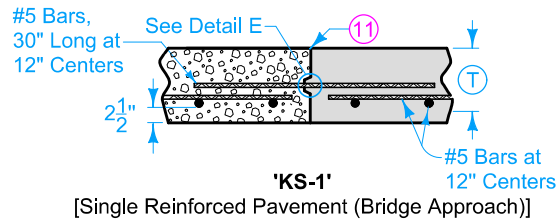
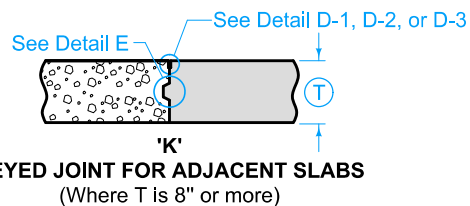

(T)	Joint	Bars	Bar Length and Spacing
< 8"	'KT-1'	#4	30" Long at 30" Centers
		#5	30" Long at 30" Centers
≥ 8"	'KT-2'	#5	30" Long at 30" Centers
	'KT-3'	#5	30" Long at 15" Centers

LONGITUDINAL CONTRACTION

- (10) Bar supports may be necessary for fixed form paving to ensure the bar remains in a horizontal position in the plastic concrete.
- (11) Sawing or sealing of joint not required.
- (12) The following joints are interchangeable, subject to the pouring sequence:
'BT-1', 'L-1', and 'KT-1'
'KT-2' and 'L-2'
'KT-3' and 'L-3'

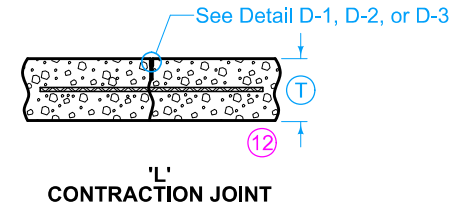

(T)	Joint	Bars	Bar Length and Spacing
< 8"	'L-1'	#4	36" Long at 30" Centers
≥ 8"	'L-2'	#5	36" Long at 30" Centers
	'L-3'		36" Long at 15" Centers

LEGEND

Existing Pavement

Proposed Pavement

SUDAS	IOWADOT	REVISION
		10 04-21-20
FIGURE 7010.101	STANDARD ROAD PLAN	PV-101
		SHEET 3 of 8

REVISIONS: Modified Dowel Assemblies on Sheets 6 and 7 to eliminate reference to 14" pavements.

Paul D. Wigand SUDAS DIRECTOR *Steve Miller* DESIGN METHODS ENGINEER

JOINTS

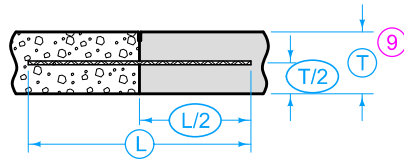

TIE BAR PLACEMENT
(Applies to all joints unless otherwise detailed.)

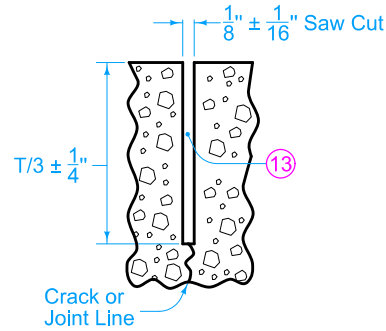

DETAIL D-1
(Required when specified in the contract documents.)

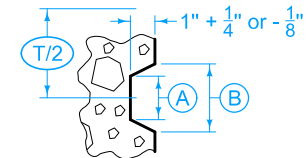

DETAIL E

- ⑨ When tying into old pavement, (T) represents the depth of sound PCC.
- ⑬ Sealant or cleaning not required.

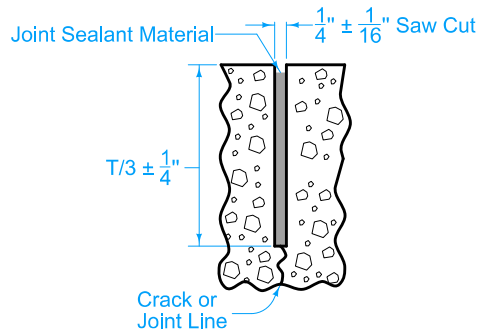

DETAIL D-2
(Required when the Department of Transportation is not the Contracting Authority, or when specified in the contract documents)

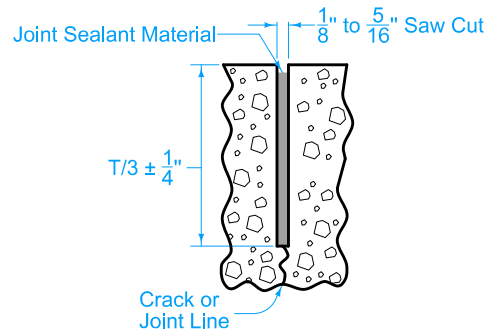

DETAIL D-3
(Required when the Department of Transportation is the Contracting Authority, or when specified in the contract documents)

KEYWAY DIMENSIONS			
Keyway Type	Pavement Thickness (T)	(A)	(B)
Standard	8" or greater	1 3/4"	2 3/4"
Narrow	Less than 8"	1"	2"

LEGEND	
	Existing Pavement
	Proposed Pavement

		REVISION
		10 04-21-20
FIGURE 7010.101	STANDARD ROAD PLAN	PV-101
		SHEET 4 of 8

REVISIONS: Modified Dowel Assemblies on Sheets 6 and 7 to eliminate reference to 14" pavements.

Paul D. Wigand
SUDAS DIRECTOR

Stuart Nade
DESIGN METHODS ENGINEER

LONGITUDINAL CONTRACTION

JOINTS

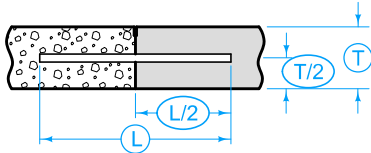

DOWEL PLACEMENT
(Applies to all joints unless otherwise detailed.)

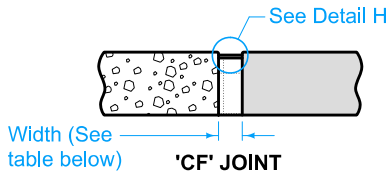

'CF' JOINT

TYPE	WIDTH
CF-1	2"
CF-2	2 1/2"
CF-3	3"
CF-4	3 1/2"

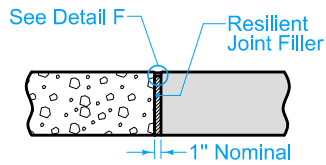

'E' 1" EXPANSION JOINT

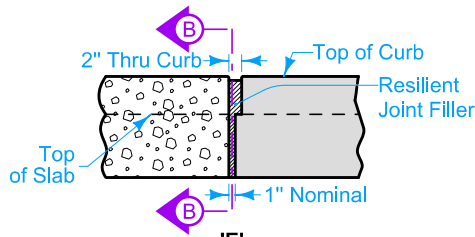

'E' JOINT IN CURB
(View at Back of Curb)

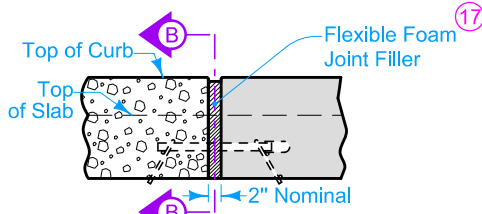

'EE' JOINT IN CURB
(View at Back of Curb)

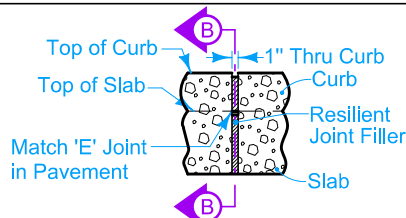

'ES' JOINT IN CURB
(View at Back of Curb)

Detail F or Detail G
(See Bar Size Table for Doweled Expansion Joints)

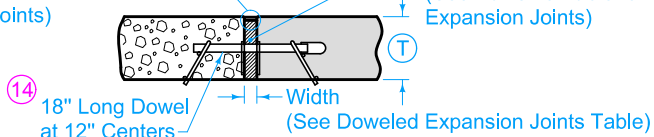

'ED', 'EE', 'EF' DOWELED EXPANSION JOINT

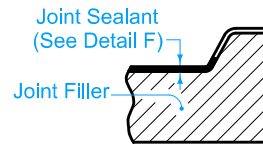

SECTION B-B

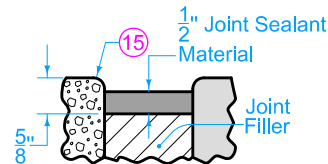

DETAIL F

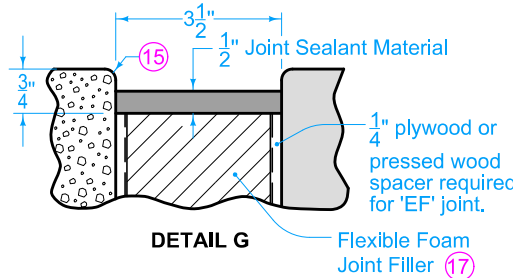

DETAIL G

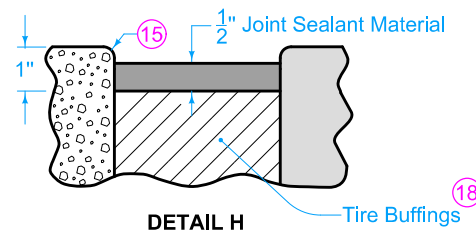

DETAIL H

EXPANSION

- ⑭ See Bar Size Table for Doweled Expansion Joints.
- ⑮ Edge with 1/4 inch tool for length of joint indicated if formed; edging not required when cut with diamond blade saw.
- ⑯ See Dowel Assemblies for fabrication details and placement limits. Coat the free end of dowel bar to prevent bond with pavement. At intake locations, dowel bars may be cast-in-place.
- ⑰ Predrill or preform holes in joint material for appropriate dowel size.
- ⑱ Compact tire buffings by spading with a square-nose shovel.

DOWELED EXPANSION JOINTS

TYPE	WIDTH	FILLER MATERIAL ⑰
ED	1"	Resilient (Detail F)
EE	2"	Flexible Foam (Detail F)
EF	3 1/2"	Flexible Foam (Detail G)

BAR SIZE TABLE FOR DOWELED EXPANSION JOINTS

T	< 8"	≥ 8" but < 10"	≥ 10"
Dowel Diameter	3/4"	1 1/4"	1 1/2"

Tubular Dowel Bars will not be allowed for expansion joints.

LEGEND

	Existing Pavement
	Proposed Pavement

		REVISION
		10 04-21-20
FIGURE 7010.101	STANDARD ROAD PLAN	PV-101
		SHEET 5 of 8

REVISIONS: Modified Dowel Assemblies on Sheets 6 and 7 to all in-date reference to 14" pavements.

Paul D. Wigand
SUDAS DIRECTOR

Steve Nade
DESIGN METHODS ENGINEER

JOINTS

CONTRACTION JOINTS

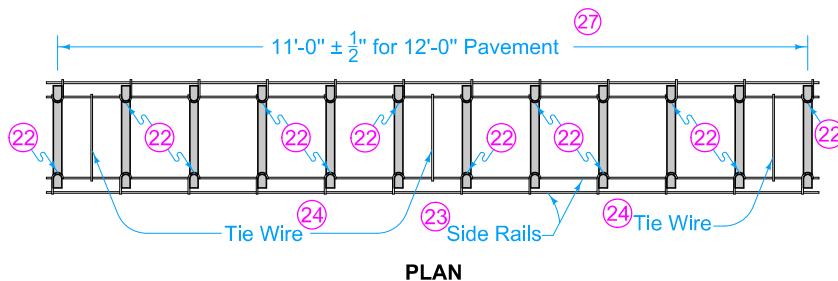

Spaces between dowel bars are nominal dimensions with a $\frac{1}{4}$ " allowable tolerance.

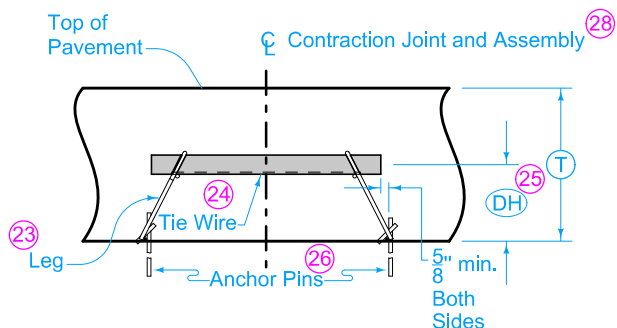
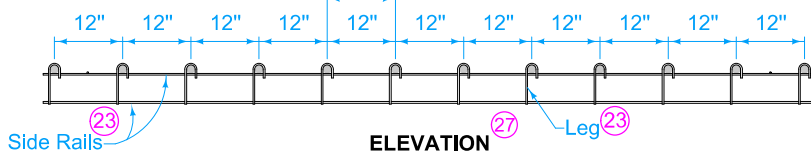

LONGITUDINAL SECTION

DOWEL ASSEMBLIES

19 20 21

DOWEL HEIGHT AND DIAMETER FOR DOWELED CONTRACTION JOINTS			
T	DH 25	Diameter (Solid)	Diameter (Tubular)
7" to 7 $\frac{1}{2}$ "	3 $\frac{1}{2}$ "	$\frac{3}{4}$ "	$\frac{7}{8}$ "
8" to 9 $\frac{1}{2}$ "	4 $\frac{1}{4}$ "	1 $\frac{1}{4}$ "	1 $\frac{3}{8}$ "
10" to 11 $\frac{1}{2}$ "	5 $\frac{1}{4}$ "	1 $\frac{1}{2}$ "	1 $\frac{5}{8}$ "
12" to 13"	6 $\frac{1}{4}$ "	1 $\frac{1}{2}$ "	1 $\frac{5}{8}$ "

Tubular Dowel Bars will not be allowed for RD joints.

- 19 Use 18 inch long dowel bars with a tolerance of $\pm 1/8$ inch. Ensure the centerlines of individual dowels are parallel to the other dowels in the assembly within $\pm 1/8$ inch.
- 20 Use wires with a minimum tensile strength of 50 ksi.
- 21 Details apply to both transverse contraction and expansion joints.
- 22 Weld alternately throughout.
- 23 0.306 inch diameter wire. Wire sizes shown are the minimum required.
- 24 Maximum 0.177 inch diameter wire, welded or friction fit to upper side rail, both sides.
- 25 Measured from the centerline of dowel bar to bottom of lower side rail + 1/4 inch.
- 26 Per lane width, install a minimum of 8 anchor pins evenly spaced (4 per side), to prevent movement of assembly during construction. Anchor assemblies placed on pavement or PCC base with devices approved by the Engineer.
- 27 If dowel basket assemblies are required for curbed pavements, the assembly length is based on the jointing layout. See PV-101, sheet 8.
- 28 Ensure dowel basket assembly centerline is within 2 inches of the intended joint location longitudinally and has no more than 1/4 inch horizontal skew from end of basket to end of basket.

		REVISION	
		10	04-21-20
FIGURE 7010.101	STANDARD ROAD PLAN	PV-101	
REVISIONS: Modified Dowel Assemblies on Sheets 6 and 7 to eliminate reference to 14' pavements.		SHEET 6 of 8	
SUDAS DIRECTOR		DESIGN METHODS ENGINEER	
JOINTS			

EXPANSION JOINTS

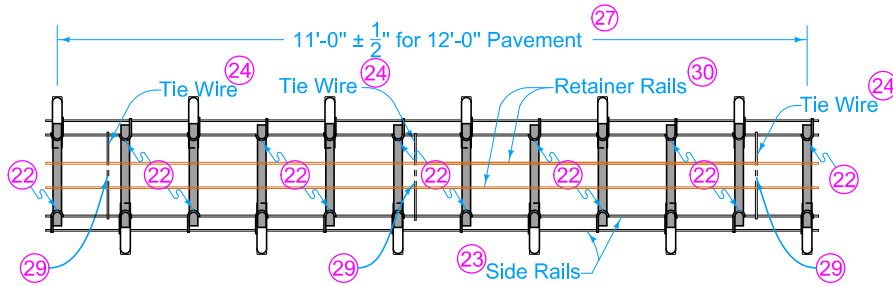

PLAN

Spaces between dowel bars are nominal dimensions with a 1/4" allowable tolerance.

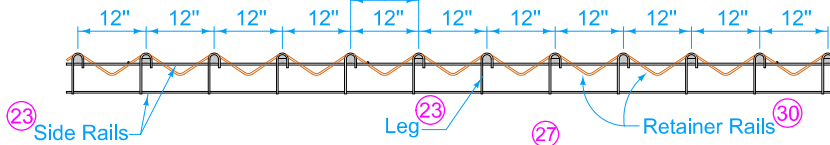

ELEVATION

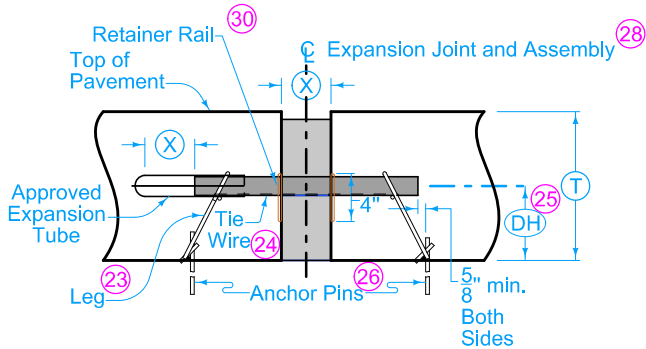

SECTION THRU EXPANSION JOINT

JOINT OPENING AND EXPANSION TUBE EXTENSION		
Joint Type	(X)	Minimum Tube Length
"ED"	1"	6"
"EE"	2"	7"
"EF"	3 1/2"	9"

DOWEL HEIGHT AND DIAMETER FOR DOWELED EXPANSION JOINTS

(T)	(DH) (25)	Diameter
7" to 7 1/2"	3 1/2"	3/4"
8" to 9 1/2"	4 1/4"	1 1/4"
10" to 11 1/2"	5 1/4"	1 1/2"
12" to 13"	6 1/4"	1 1/2"

Tubular Dowel Bars will not be allowed for expansion joints.

DOWEL ASSEMBLIES

(19) (20) (21)

- (19) Use 18 inch long dowel bars with a tolerance of $\pm 1/8$ inch. Ensure the centerlines of individual dowels are parallel to the other dowels in the assembly within $\pm 1/8$ inch.
- (20) Use wires with a minimum tensile strength of 50 ksi.
- (21) Details apply to both transverse contraction and expansion joints.
- (22) Weld alternately throughout.
- (23) 0.306 inch diameter wire. Wire sizes shown are the minimum required.
- (24) Maximum 0.177 inch diameter wire, welded or friction fit to upper side rail, both sides.
- (25) Measured from the centerline of dowel bar to bottom of lower side rail + 1/4 inch.
- (26) Per lane width, install a minimum of 8 anchor pins evenly spaced (4 per side), to prevent movement of assembly during construction. Anchor assemblies placed on pavement or PCC base with devices approved by the Engineer.
- (27) If dowel basket assemblies are required for curbed pavements, the assembly length is based on the jointing layout. See PV-101, sheet 8.
- (28) Ensure dowel basket assembly centerline is within 2 inches of the intended joint location longitudinally and has no more than 1/4 inch horizontal skew from end of basket to end of basket.
- (29) Clip and remove center portion of tie during field assembly.
- (30) 1/4 inch diameter wire.

FIGURE 7010.101 SHEET 7 OF 8

		REVISION
		10 04-21-20
FIGURE 7010.101	STANDARD ROAD PLAN	PV-101
		SHEET 7 of 8
<small>REVISIONS: Modified Dowel Assemblies on Sheets 6 and 7 to eliminate reference to 14' pavements.</small>		
 SUDAS DIRECTOR		 DESIGN METHODS ENGINEER
JOINTS		

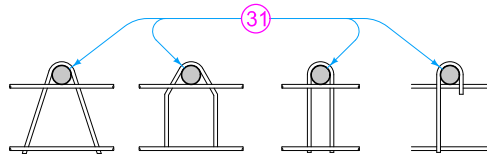

OPTIONAL LEG SHAPES

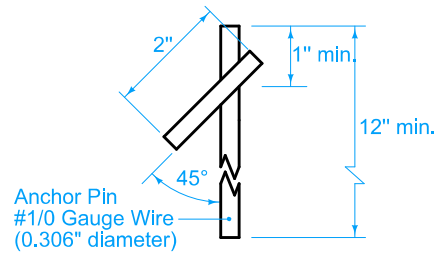

ANCHOR PIN

- 19 Use 18 inch long dowel bars with a tolerance of $\pm 1/8$ inch. Ensure the centerlines of individual dowels are parallel to the other dowels in the assembly within $\pm 1/8$ inch.
- 20 Use wires with a minimum tensile strength of 50 ksi.
- 21 Details apply to both transverse contraction and expansion joints.
- 31 Diameter of bend around dowel is dowel diameter + $1/8$ to $3/16$ inches.
- 32 For uniform lane widths: 3" - 6". For taper and variable width pavements: 3" - 12".

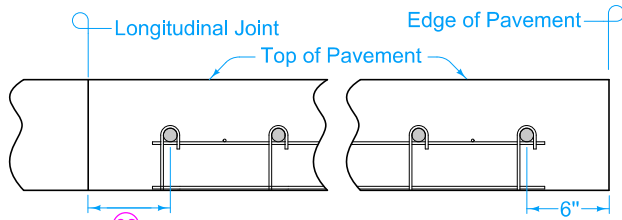

PLACEMENT LIMITS
(Rural Section)

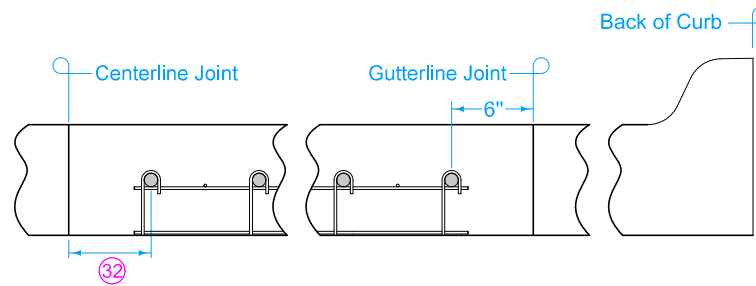

PLACEMENT LIMITS
(Curb and Gutter - Gutterline Jointing)

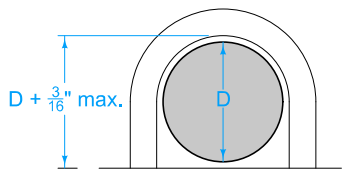

BEND AROUND DOWEL

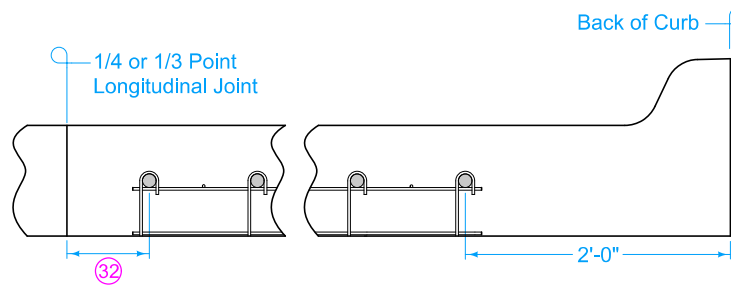

PLACEMENT LIMITS
(Curb and Gutter - 1/4 or 1/3 Point Jointing)

DOWEL ASSEMBLIES

19 20 21

		REVISION
		10 04-21-20
FIGURE 7010.101	STANDARD ROAD PLAN	PV-101
		SHEET 8 of 8
<small>REVISIONS: Modified Dowel Assemblies on Sheets 6 and 7 to eliminate reference to 14' pavements.</small>		
 SUDAS DIRECTOR		 DESIGN METHODS ENGINEER
JOINTS		