

TYPE 4A GRATE ①

Minimum Weight = 65 lbs.

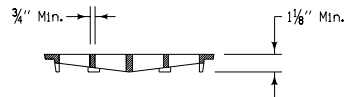
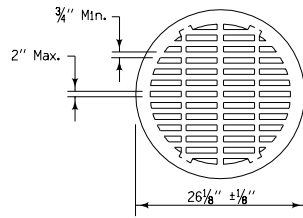

TYPE 4B GRATE ①

Minimum Weight = 100 lbs.

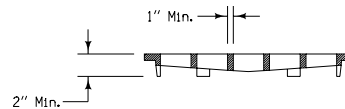
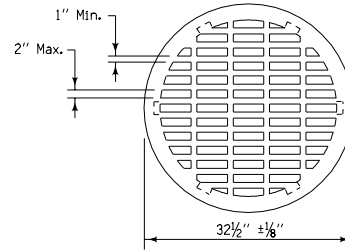

TYPE 4C GRATE ①

Minimum Weight = 160 lbs.

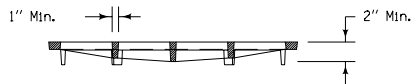
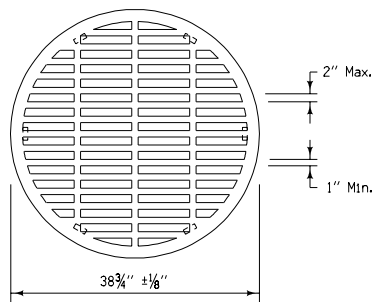

TYPE 4D GRATE ①

Minimum Weight = 240 lbs.

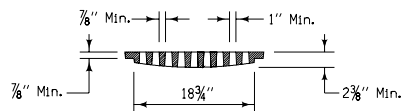
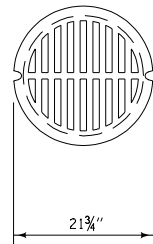

TYPE 9 GRATE ②

Minimum Weight = 85 lbs.

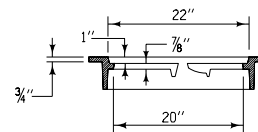
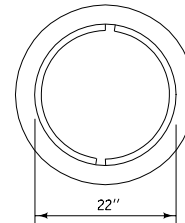

TYPE 9 FRAME

Minimum Weight = 75 lbs.

- ① For Type 4 grates, a frame is required only when specified in detailed plans. Frames shall be of adequate and proper dimensions to satisfactorily accommodate the grates.
- ② Unless otherwise specified, Type 9 grate shall be cast without locking lugs so that it may be used in an inverted position when so desired.

TYPE 4 FRAME REQUIREMENTS	
TYPE	D - PIPE DIAMETER
4A	18"
4B	24"
4C	30"
4D	36"

STANDARD ROAD PLAN RA-66C	
REVISION: Remove General Notes.	REVISION NO. 2
<i>William J. Stein</i> <small>APPROVED BY DESIGN METHODS ENGINEER</small>	REVISION DATE 10-19-04

INTAKE GRATES
TYPES 4A, 4B, 4C, AND 4D
AND GRATE AND FRAME TYPE 9