

TYPICAL PLAN WITH ELBOW

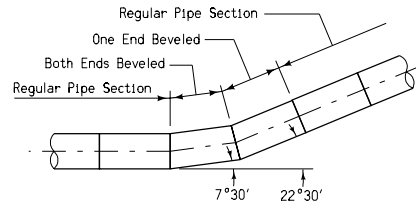

TYPICAL PLAN WITH "D" SECTIONS

REINFORCING BARS		
Size "D"	Bar Size	Number Required
12" - 21"	3/8"	4
24" - 42"	3/8"	8
48" - 60"	1/2"	8
66" - 84"	5/8"	8

GENERAL NOTES:

Concrete pipe elbows and Type "D" pipe sections shall be fabricated in conformance with Standard Road Plan RF-1 for the size and class of pipe specified.

Wire reinforcing shall meet the requirements of AASHTO M 32.

Degree of elbow required shall be as indicated on detail plan for each individual installation.

Minimum length of elbow shall be 5'-6" measured along centerline of pipe. Design length of pipe shall be considered 6'-0".

Elbows shall be fabricated by a method approved by the Engineer and resulting in a finished product essentially as indicated hereon. The typical method for fabricating elbow is as follows: Steel rods, as specified, shall be attached to the normal wire reinforcing cage as indicated hereon. After pipe is cast, a cut 50% of the degree of elbow desired shall be made as indicated, and the reinforcing rods and mesh cut on centerline of the cut. The severed section of pipe shall then be rotated 180 degrees and the reinforcing rods reworked to the opposite rods. The remaining opening shall then be patched with cement mortar to effect a satisfactorily completed elbow as shown.

Unless specified otherwise, the Type "D" section shall be beveled on a 7.5 degree miter and the bevel may be provided on either the tongue end or groove end of the pipe. In certain cases, both ends of the pipe section may require the beveled end.

Type "D" pipe sections shall be included in measurement for pipe culvert. No payment shall be made specifically for the Type "D" section bevel. It shall be considered incidental to the price bid.

Half Pipe shall conform to the requirements for 2000D as shown on Standard Road Plan RF-1 for the size specified. Maximum "D" size for Half Pipe is 48 inches. Unless specified otherwise, Half Pipe shall be fabricated with connector holes as indicated.

Minimum length of Half Pipe section shall be 4'-0". The minimum number of 4'-0" sections shall be used to make up the necessary length of Half Pipe Flume as indicated on detail plans. Normal length shall be 6'-0".

Price bid for Half Pipe, per foot, shall be considered full compensation for furnishing and installing Half Pipe in accordance with plan requirements.

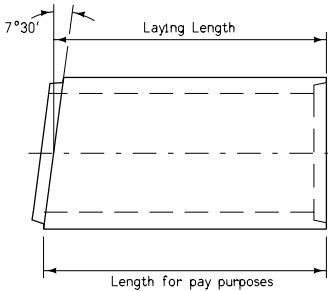

TYPE "D" SECTION (SINGLE BEVEL)

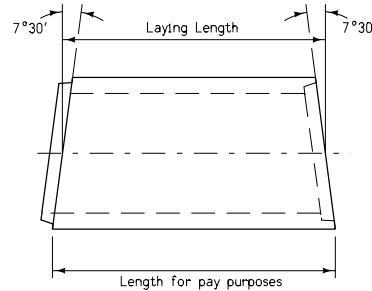

TYPE "D" SECTION (DOUBLE BEVEL)

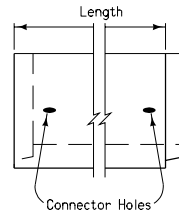

DETAILS OF HALF PIPE SECTION

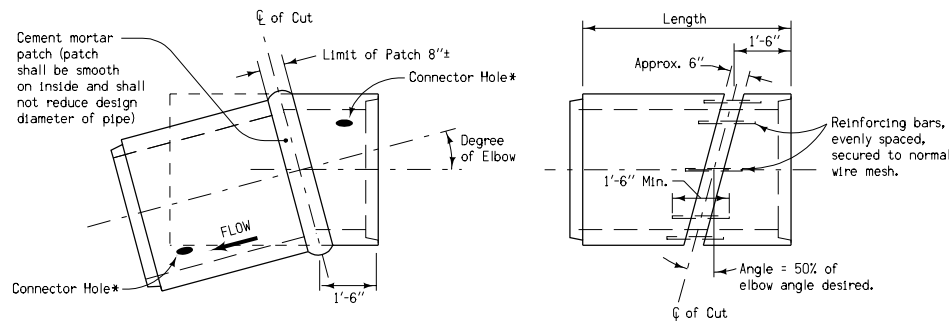
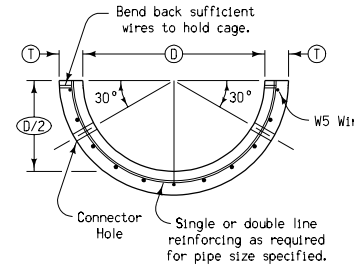

TYPICAL CONCRETE PIPE ELBOW

* See Standard Road Plan RF-14

SPECIAL NOTE:

For pipe sizes up through 48" in diameter, bends may be accomplished in increments of 7.5 degrees by using standard "D" sections in appropriate combinations.

For pipe sizes from 54" through 72" in diameter, the "D" section shall be as specified, limited to a maximum of 5 degree miter on any one end of pipe section.

For pipe sizes through 48" in diameter, bends from 15 to 45 degrees may be accomplished using a single elbow. Bends more than 45 degrees require two elbows unless approved otherwise by the Engineer.

The Contractor may substitute an approved elbow for "D" section bends of 15 degrees or less. Such elbows will not be measured for payment but shall be considered incidental to price bid for culvert pipe.

 Iowa Department of Transportation Highway Division	
STANDARD ROAD PLAN	RF-13
REVISION: Correct angle in "Typical Plan with 'D' sections".	REVISION NO. 5
<i>Deanna Masfield</i> APPROVED BY DESIGN METHODS ENGINEER	REVISION DATE 04-18-06
PIPE BENDS AND HALF PIPE	