

PLAN VIEW OF TYPICAL LONGITUDINAL SUBDRAIN INSTALLATIONS

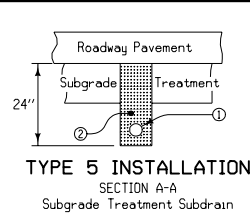

TYPE 5 INSTALLATION
SECTION A-A
Subgrade Treatment Subdrain

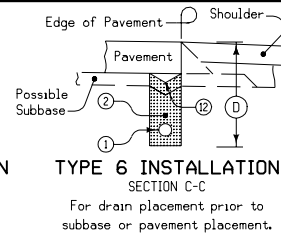

TYPE 6 INSTALLATION
SECTION C-C
For drain placement prior to subbase or pavement placement.

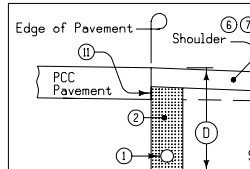

TYPE 7A INSTALLATION
SECTION C-C

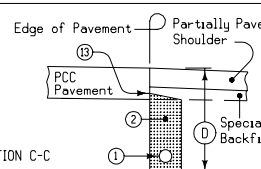

TYPE 7B INSTALLATION
SECTION C-C

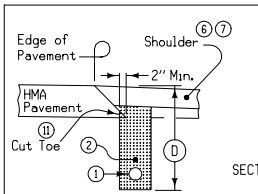

TYPE 8A INSTALLATION
SECTION C-C

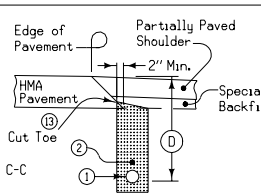

TYPE 8B INSTALLATION
SECTION C-C

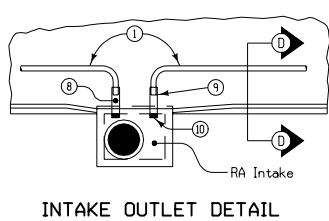

INTAKE OUTLET DETAIL

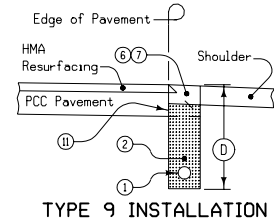

TYPE 9 INSTALLATION
SECTION C-C
Composite Pavement with Existing Shoulder

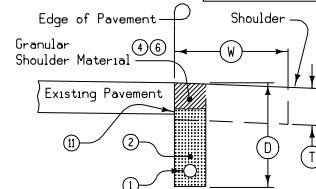

TYPE 10 INSTALLATION
SECTION C-C
HMA Base Widening

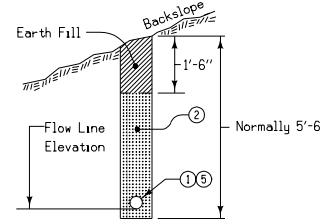

TYPE 11 INSTALLATION
SECTION B-B
Backslope

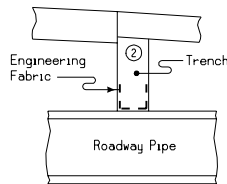

SECTION E-E

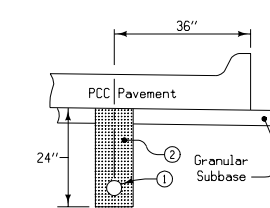

TYPE 12 INSTALLATION
SECTION D-D

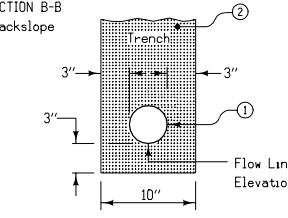

TUBING PLACEMENT DETAIL
ALL TYPES

When RCB culverts or RF-1 concrete pipe culverts which are less than 1 foot below the trench bottom are encountered within a tabulated subdrain, the trench shall stop 3 feet from the culvert and resume 3 feet beyond the culvert. If the trench is inadvertently carried over the culvert, the trench shall be repaired as detailed on this sheet. Care must be exercised so as not to destroy the tops of culverts with the trenching machine. If obstruction is 1 foot or more below trench bottom, carry subdrain line over in continuous alignment.

Subdrain trench shall typically be located adjacent to edge of roadway pavement. On new construction projects, the subdrain shall be placed after the earth shoulder fill and special backfill, if required, and prior to granular or paved shoulder material.

Contract Items:

Subdrain, Longitudinal
Subdrain Outlet (RF-19C)
Tabulation: 104-9

- 1 4" Perforated Subdrain (Polyethylene, Corrugated Tubing).
- 2 Porous Backfill for Subdrain (compacted).
- 3 Subdrain outlets. See Standard Road Plan RF-19E.
- 4 Backfill of this area is not required if base widening is placed the same day of subdrain construction.
- 5 Subdrain is to be installed as cut proceeds.
- 6 On existing Granular or Earth Shoulders, replace with 4" minimum depth granular shoulder material. Shoulder material will be incidental to the longitudinal subdrain bid item.
- 7 On Paved Shoulders, refer to "Subdrains" in the current Standard Specifications for finishing shoulder.
- 8 6" corrugated metal pipe or 4" corrugated double-walled PE or PVC pipe (2'-0" long) will be paid for as "Subdrain Outlet (RF-19C)."
- 9 PE or PVC outlet to be connected with an appropriate coupler. CMP outlet to be connected in one of two ways: (1) Inside-fit reducer coupler (1'0" min. fit inside CMP); or (2) Insert 1'-0" of the 4" subdrain into 6" CMP and fully seal entire opening with grout.
- 10 Removable Grate Rodent Guard. See Materials I.M. 443.01.
- 11 The porous backfill shall be in direct contact with a minimum of 2.0" of pavement and continuous to shoulder material as per note 6 or 7.
- 12 "V" notch shall be cut just prior to subbase (if proposed) or pavement placement to assure uncontaminated contact.
- 13 Top of subdrain trench shall be at the bottom of pavement. Backfill trench so that a wedge of porous backfill has a minimum vertical contact of 2 inches with the pavement.

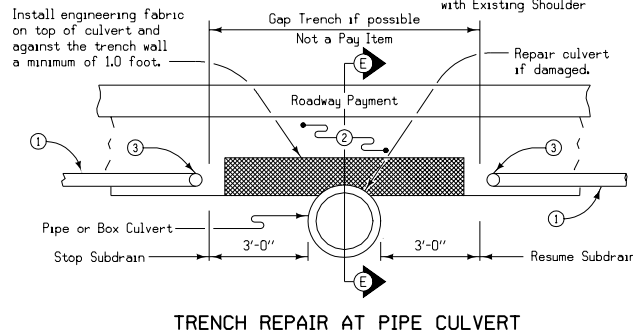

TRENCH REPAIR AT PIPE CULVERT

STANDARD ROAD PLAN RF-19C	
REVISION: Add Type 7B and 8B installations for partially paved shoulders.	REVISION NO. 13
APPROVED BY DESIGN METHODS ENGINEER <i>William J. Allen</i>	REVISION DATE 10-18-05
SUBDRAINS (LONGITUDINAL)	