

TYPE 1 ATTACHMENT

Type 1 Attachment shall be used for all signs placed on metal breakaway posts.

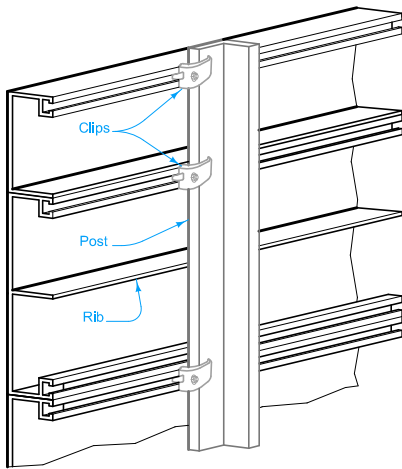

TYPE 4 ATTACHMENT

Type 4 Attachment shall be used for all signs mounted on overhead sign support structures.

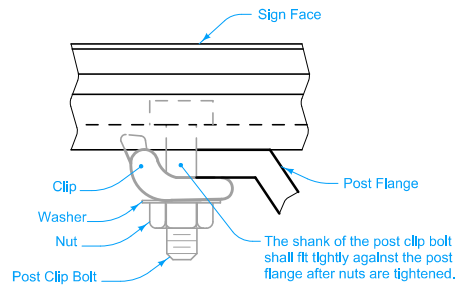
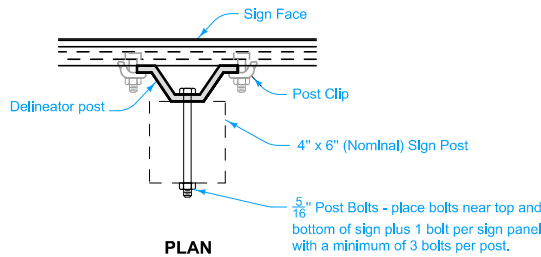

CLIP INSTALLATION

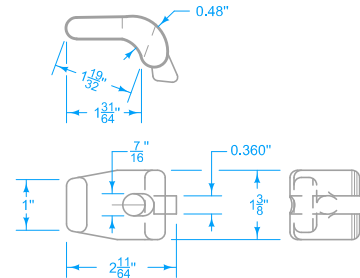

POST CLIP

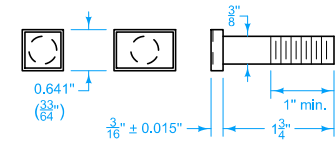

CLIP BOLT
(Square or Rectangular Head Optional)

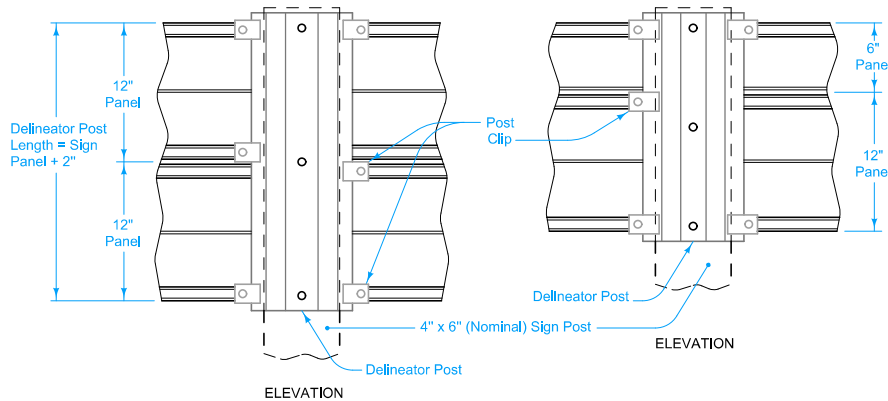

ELEVATION

ELEVATION

TYPE 3 ATTACHMENT

Use Type 3 Attachment for all signs with wood posts.

Position the EXIT NUMBER PANEL above the guide sign aligned with the edge of the guide sign indicating direction of exit.

If the bolt holes in the top panel and the bottom panel of the two signs line up, panel bolts are to be used.

If the angle fasteners can not be horizontally placed as shown, they can be moved so as to securely hold the top sign.

A post clip is required on each angle at top of panel and each extrusion joint.

The aluminum angles are considered part of the mounting hardware and are to be furnished by the Contractor as an incidental item. No separate payment will be made for aluminum angles.

Use cast aluminum post clips and stainless steel nuts, bolts, and washers for post clips meeting the requirements of Article 4186.09, B of the Standard Specifications.

 STANDARD ROAD PLAN	REVISION
	4 04-17-18
	SI-132
SHEET 1 of 2	

REVISIONS: Added thickness dimension for post clip. Specified material for the post clip, and the nut, bolt, and washer fastening the post clip.

Brian Smith
APPROVED BY DESIGN METHODS ENGINEER

**INSTALLATION -
TYPE 'B' SIGNS**

- ① Do not allow the aluminum L to extend below the bottom of the major sign.
- ② Sign height added above existing supports.

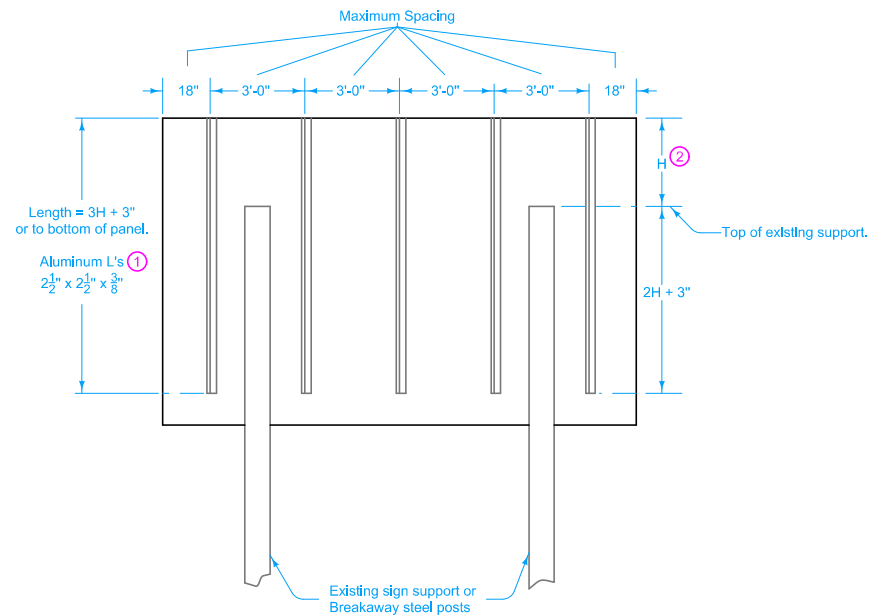
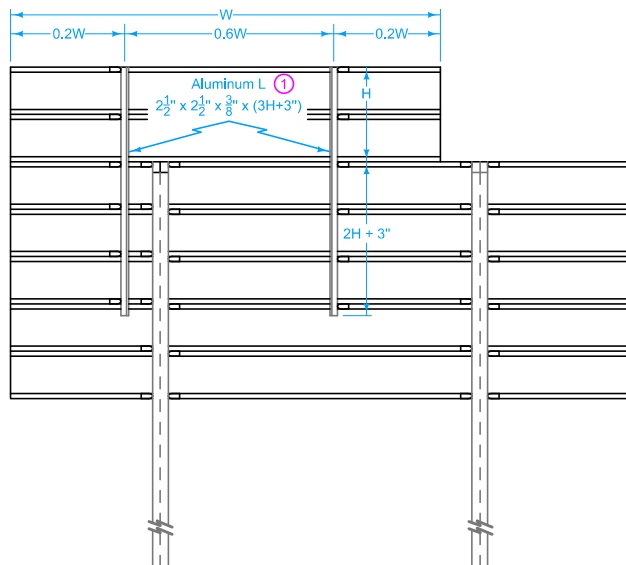

GUIDE SIGNS

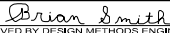
IOWA DOT	REVISION	
	4	04-17-18
STANDARD ROAD PLAN		SI-132
		SHEET 2 of 2
<small>REVISIONS: Added thickness dimension for post clip. Specified material for the post clip, and the nut, bolt, and washer fastening the post clip.</small>		
 <small>APPROVED BY DESIGN METHODS ENGINEER</small>		
INSTALLATION - TYPE 'B' SIGNS		