

TABLE OF CONTENTS ~ RAILINGS

- 5.8.1 Railings
 - 5.8.1.1 General
 - 5.8.1.1.1 Policy overview [AASHTO-LRFD 13.7.2]
 - 5.8.1.1.2 Design information
 - 5.8.1.1.3 Definitions
 - 5.8.1.1.4 Abbreviations and notation [AASHTO-LRFD 13.7.2]
 - 5.8.1.1.5 References
 - 5.8.1.2 Permanent railings
 - 5.8.1.2.1 Traffic railings [AASHTO-LRFD 13.7.2]
 - 5.8.1.2.1.1 Single slope [AASHTO-LRFD 13.7.3.2]
 - 5.8.1.2.1.2 Open
 - 5.8.1.2.1.3 Retrofit
 - 5.8.1.2.2 Pedestrian railings [AASHTO-LRFD 13.8]
 - 5.8.1.2.3 Bicycle railings [AASHTO-LRFD 13.9]
 - 5.8.1.2.4 Separation railings [AASHTO-LRFD C13.7.1.1, 13.10]
 - 5.8.1.2.5 Aesthetic and special railings [AASHTO-LRFD 13.7-13.9]
 - 5.8.1.2.6 Concrete railings
 - 5.8.1.3 Temporary barrier railings
 - 5.8.1.3.1 Concrete
 - 5.8.1.3.2 Steel

5.8.1 Railings

Previously traffic railings have been rated according to the crash test standards contained in *National Cooperative Highway Research Program (NCHRP) Report 350* (1993). Current traffic railings shall normally meet the design and testing requirements in the Manual for Assessing Safety Hardware (MASH), 2nd edition, 2016. The Department has preapproved traffic railings and other roadside safety hardware for use in accordance with documentation in OD DM 8A-5. The traffic railings discussed in this article have been preapproved for use on the state system subject to the limitations outlined in this article for each railing. Making modifications to these traffic railings is discouraged. Any modifications to these traffic railings must be approved by the Department. Using traffic railings other than those discussed in this article is discouraged. Any traffic railing for a state project or state-owned structure must be approved for use by the Department. The AASHTO LRFD provisions for railings include information based on NCHRP 350 and MASH. The Bureau has designed the deck overhang on standard sheets according to the MASH requirements in the AASHTO LRFD Specifications and BDM 5.2.

Because traffic railings are attached to the bridge deck, the designer also should consult the decks article in this manual [BDM 5.2]. The intent of the traffic railing and supporting deck design is to make the deck stronger than the railing so that a crash-related railing failure will not propagate into the superstructure [BDM 5.2.2.4]. Designers should also generally be aware of the zone of intrusion requirements as given in BDM 3.14 and OD DM 8A-6.

Bureau policies for aesthetic and special railings currently are under discussion. As needed, contact the Methods Engineer for policies to be applied to specific projects.

5.8.1.1 General

5.8.1.1.1 Policy overview [AASHTO-LRFD 13.7.2]

Most new Iowa highway bridges are designed only for vehicular traffic and make use of the single slope barrier rails detailed on standard sheets developed by the Bureau. The 38-inch tall and 44-inch tall Iowa standard single slope barrier rails meet MASH Test Level 4 (TL-4) and Test Level 5 (TL-5) criteria,

respectively. Note that the Iowa standard single slope barrier rails are 2 inches taller than the minimum heights required for TL-4 and TL-5 barrier rails to account for the possibility of a 2 inch thick future overlay. Although TL-4 is adequate for most Iowa highways, the Highway Division Management Team adopted a more conservative policy that requires TL-5 rails for all mainline interstate bridges and for primary highway bridges with certain conditions as noted in BDM 5.8.1.2.1. The designer will need to check all primary highway bridges with respect to the policy.

All barrier rail to bridge deck/wing reinforcement for interstate and primary bridges shall be stainless steel. All other barrier rail and median barrier reinforcing steel, longitudinal and transverse, shall be epoxy coated.

General requirements for rural and urban areas regarding the size and number of conduits placed in rails are listed under the figures of each rail type in the articles below. For a fuller discussion of conduit and lighting requirements see BDM C5.8.1.1.1.

Bureau standard sheets detail two types of single slope end sections and single slope standard sections for all typical conditions. The first vertical end post section type is for high-speed highways that require connections for three beam guardrail beyond the bridge. The second, rounded or sloped end section type is for low-speed highways in urban areas where no guardrail connection is necessary. The maximum posted speed for use of a sloped end transition (SET) without consultation with the BSB is 30 MPH. Refer to Design Manual Section 8A-4 for guidance. In cases where the railing has a maximum expansion joint opening 4 inches or greater the designer will need to provide steel cover plates [BDM 5.8.1.2.6].

The standard single slope barrier rails are tall enough that they restrict sight distance for motorists in some vehicles, and in some highway situations an open railing may be advisable. When selecting railings the Bureau also considers splash protection during snow plowing for railways and roadways underneath a bridge.

In urban areas a bridge often will include a sidewalk or shared-use trail along one or both edges of the roadway. Standard sheets developed by the Bureau provide for a sidewalk and separation barrier along the edge of a roadway. The Iowa DOT considers that bridge sidewalks will occasionally accommodate bicyclists, especially children, and as such the railings on both sides should meet minimum bicycle height requirements [BDM 5.8.1.2.2, BDM 5.8.1.2.3]. The separation barrier is typically a combination railing constructed with a concrete lower section to which a steel railing is attached to meet minimum bicycle height requirements [BDM 5.8.1.2.4]. At the outer edge of the bridge a chain link fence or other railing is provided for protection of pedestrians.

For bridges given special aesthetic treatment, traffic railings often become topics of conversation relative to enhancement plans. However, modifications to crash-tested barriers that impact the height, traffic face geometry, or strength of the barrier system are not typically possible. Outside face treatments such as texturing of concrete using form liners is acceptable in most cases if there is no impact on barrier strength. The associated constructability, cost, and construction schedule concerns must also be adequately addressed in the planning stages of the project. For more detailed information on aesthetic barriers and potential treatments, see BDM 5.8.1.2.5.

Upgrades to existing traffic railings or barrier rails during repair projects and requirements for rail retrofits are given in the bridge repair article of this manual [BDM 12.1].

For staged construction the Design Bureau usually is responsible for layout of temporary barrier rail (TBR). The Bridges and Structures Bureau generally provides input on the placement of the TBR with respect to the deck cross-section. Information on the use of TBR is given in this railings article and in the bridge repair article [BDM 5.8.1.3, 9.1.8.3].

5.8.1.1.2 Design information

If a bridge project requires traffic railings crash tested above Test Level 4 or 5 (TL-4 or TL-5) or if attachment of guardrail is unusual, the Methods Unit in the Design Bureau will provide the designer with appropriate information. The designer should consult with the Design Bureau as needed.

5.8.1.1.3 Definitions

F-shape was the safety shape typically used by the Bureau for traffic railings under NCHRP 350 testing requirements. Although it is similar to a New Jersey shape, the F-shape reduces vehicular climbing.

Primary Highway System: "Primary roads" or "primary road system" means those roads and streets both inside and outside the boundaries of municipalities which are under department (defined as state department of transportation) jurisdiction [Iowa Code 306.3.6].

5.8.1.1.4 Abbreviations and notation [AASHTO-LRFD 13.7.2]

CCS, continuous concrete slab

CWPG, continuous welded plate girder

FHWA, Federal Highway Administration

NCHRP, National Cooperative Highway Research Program

NHS, National Highway System

PPCB, pretensioned prestressed concrete beam

RSB, rolled steel beam

SET, sloped end transition

TBR, temporary barrier rail

TL-2, TL-3, TL-4, TL-5, TL-6, test levels for traffic railings [AASHTO-LRFD 13.7.2]

ZOI, zone of intrusion

5.8.1.1.5 References

American Association of State Highway and Transportation Officials (AASHTO). *A Policy on Geometric Design of Highways and Streets, Fourth Edition—The Green Book*. Washington: AASHTO, 2001.

American Association of State Highway and Transportation Officials (AASHTO). *Guide for the Development of Bicycle Facilities*. Washington: AASHTO, 1999.

American Association of State Highway and Transportation Officials (AASHTO). *Guide Specifications for Bridge Railings*. Washington: AASHTO, 1989.

American Association of State Highway and Transportation Officials (AASHTO). *Roadside Design Guide*. Washington: AASHTO, 1996.

Bligh, R.P., J.L. Briaud, A. Abu-Odeh, K.M Kim, and D.O. Saez. *Design Guidelines for Test Level 3 through Test Level 5 Roadside Barrier Systems Placed on Mechanically-Stabilized Earth Retaining Walls*. Final Report for NCHRP Project No. 22-20(2), Texas A&M Transportation Institute, College Station, Texas, June 2017.
<https://nap.nationalacademies.org/download/26580>

Bullard, D.L., N.M Sheihk, R.P. Bligh, R.R. Haug, J.R. Schutt, and B.J. Storey. *Aesthetic Concrete Barrier Design, NCHRP Report 554*. Washington: Transportation Research Board, 2006.

Department of Justice. *ADA Standards for Accessible Design*. 2010 (Available on the Internet at <https://www.ada.gov/law-and-regs/design-standards/>.)

Faller, R.K., D.L. Sicking, J. Larsen, J.R. Rohde, R.W. Bielenberg, and K.A. Polivka. *TL-5 Development of 42- and 51-in. Tall, Single-faced, F-Shape Concrete Barriers, Final Report*. Lincoln: Midwest Roadside Safety Facility, 2004.

Federal Highway Administration (FHWA). "Federal-Aid Policy Guide, Transmittal 32." Washington: FHWA, 26 October 2004. (Available on the Internet at <http://www.fhwa.dot.gov/legregs/directives/fapg/0625sup.htm>.)

Federal Highway Administration (FHWA). "NCHRP Report 350 Hardware." (The web site is at http://safety.fhwa.dot.gov/roadway_dept/policy_guide/road_hardware/barriers/bridge_railings/index.cfm.)

Horne, D.A. "Crash Testing of Bridge Railings" (a memorandum issued 30 May 1997). Washington: Federal Highway Administration, 1997. (Available on the Internet at http://safety.fhwa.dot.gov/roadway_dept/policy_guide/road_hardware/barriers/bridge_railings/docs/bridge.pdf)

Iowa DOT. Iowa Bicycle and Pedestrian Long Range Plan. 2018 (Available on the Internet at <https://iowadot.gov/iowainmotion/modal-plans/bicycle-pedestrian-plan>.)

Keller, E.A., R.K. Faller, D.L. Sicking, J.R. Rohde, and K.A. Polivka. *Guidelines for Attachments to Bridge Rails and Median Barriers, Final Report*. Lincoln: Midwest Roadside Safety Facility, 2003. (Available on the Internet at <https://digitalcommons.unl.edu/cgi/viewcontent.cgi?article=1111&context=matcreports>)

Manual for Assessing Safety Hardware (MASH), 2nd Edition, American Association of State and Highway Transportation Officials (AASHTO), Washington, D.C., 2016.

Ross, H.E., D.L. Sicking, R.A. Zimmer, and J.D. Michie. *Recommended Procedures for the Safety Performance Evaluation of Highway Features, NCHRP Report 350*. Washington: Transportation Research Board, National Research Council, 1993. (Available on the Internet at http://gulliver.trb.org/publications/nchrp/nchrp_rpt_350-a.pdf and [-b.pdf](http://gulliver.trb.org/publications/nchrp/nchrp_rpt_350-b.pdf))

Stolle, C., J. Rasmussen, L. Rodriguez, R. Faller, and N. Dowler. *Zone of Intrusion Envelopes Under MASH Impact Conditions for Rigid Barrier Attachments*. NCHRP Research Report 1018. National Academy of Sciences, 2022. (Available on the Internet at <https://www.trb.org/Publications/Blurbs/182863.aspx>)

Taylor, H.W. "Acceptance Letter B110: Texture Guidelines for SS and Vertical Concrete Barriers." Washington: Federal Highway Administration, 2002. (Available on the Internet at http://safety.fhwa.dot.gov/roadway_dept/policy_guide/road_hardware/barriers/pdf/b110.pdf)

Wright, F.G., Jr. "Bridge Rail Analysis" (a memorandum issued 16 May 2000). Washington: Federal Highway Administration, 2000. (Available on the Internet at http://safety.fhwa.dot.gov/roadway_dept/policy_guide/road_hardware/barriers/bridge_railings/docs/bridgerail_analysis_may16.pdf)

5.8.1.2 Permanent railings

5.8.1.2.1 Traffic railings [AASHTO-LRFD 13.7.2]

Test Levels (TL) and the associated heights for railings on interstate and primary road bridges is as follows:

- The need for a TL-6 railing is not anticipated for the vast majority of bridges in Iowa.
- All new interstate mainline bridges shall require a TL-5 railing, minimum height 44 inches, 42 inches plus 2 inches for future overlay.
- Bridge railing test level and the associated height for other primary highways shall be evaluated by the Pre-Design Unit in the Design Bureau for replacement structures and the Preliminary Bridge Design Unit in the Bridges and Structures Bureau for other bridges. Basically the evaluation will follow the flow chart in Figure 5.8.1.2.1.

- TL-2 and TL-3 barrier railings may also be used in low speed applications as discussed in BDM 5.8.1.2.4.

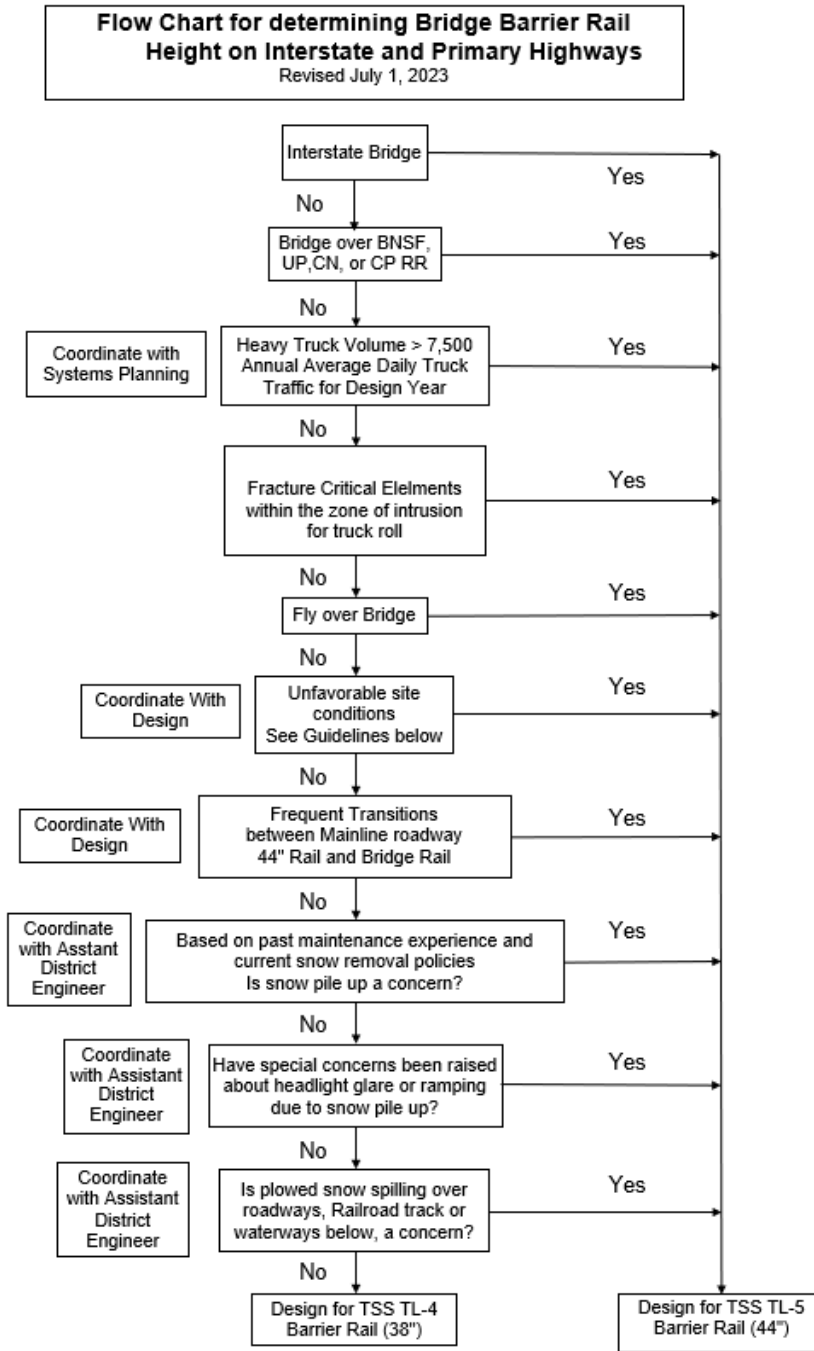

Figure 5.8.1.2.1. Flow chart for determining bridge barrier rail height on interstate and primary highways

Guidelines for unfavorable site conditions (refer to Figure 5.8.1.2.1):

- Reduced radius of curvature
- Steep down-grades on curvature

- Variable cross slopes
- Adverse weather conditions

This policy is applicable to new bridges and bridge replacements as well as to widening and repair projects that affect the existing railing. Questions regarding the policy should be directed to the Chief Structural Engineer.

5.8.1.2.1.1 Single slope [AASHTO-LRFD 13.7.3.2]

For typical bridges that carry only vehicular traffic, the Bureau provides single slope TL-4 or TL-5 barrier rails along the edges of the roadway. The Bureau standard rail heights of 38 and 44 inches provide MASH TL-4 and TL-5 crash ratings, respectively [AASHTO-LRFD 13.7.3.2] and allow for a future 2-inch bridge deck overlay. Standard sheets give details for the typical single slope barrier rails as summarized in Table 5.8.1.2.1.1-1. In most cases the complete rail design for a set of bridge plans requires both an end section sheet and a standard section sheet.

Table 5.8.1.2.1.1-1 Standard single slope barrier rails for PPCB and CWPG bridges ⁽¹⁾

Test Level	Abutment Type	Skew	Additional Information	End or Standard Rail Section	Standard Sheet Number ⁽⁴⁾
TL-4	---	---	7'-0 wing	End	1017, 1017S
TL-4	Integral	---	---	Standard	1020A, 1020SA
TL-4	Integral	---	Wing extension	Standard	1020C, 1020SC
TL-4	Integral	---	Urban approach slab with curb	End, standard	1019A, 1019SA ⁽²⁾
TL-4	Stub	No skew	Wing extension	Standard	1020B, 1020SB
TL-4	Stub	Skew	Wing extension	Standard	1018, 1018A, 1018S, 1018SA
TL-4	Stub	No skew	Urban approach slab with curb	End, standard	1019B, 1019SB1, 1019SB2 ⁽²⁾
TL-5 ⁽³⁾	Integral	---	---	Standard	1020D, 1020SD
TL-5 ⁽³⁾	Integral	---	Wing extension	Standard	1020F, 1020SF
TL-5 ⁽³⁾	Stub	No skew	Wing extension	Standard	1020E, 1020SE
TL-5 ⁽³⁾	Stub	Skew	Wing extension	Standard	1018C, 1018D, 1018SC1, 1018SC2, 1018SD1, 1018SD2

Table notes:

- (1) Signed standard bridge plans for CCS and RSB bridges still include details for standard F-shape barrier rails. Single slope rails will be added in the future as time permits.
- (2) This standard sheet currently is under review.
- (3) See Figure 5.8.1.2.1.1 for a TL-4 and TL-5 single slope cross section.
- (4) A designation of "S" in the standard sheet number indicates the use of stainless steel for the barrier rail to bridge deck/wing reinforcement.

The TL-4 and TL-5 single slope barrier rails on the standard sheets are adequate for most National Highway System (NHS) and non-NHS highways in Iowa but, in rare cases where a TL-6 rating is required, the designer will need to consult the Chief Structural Engineer regarding rail selection.

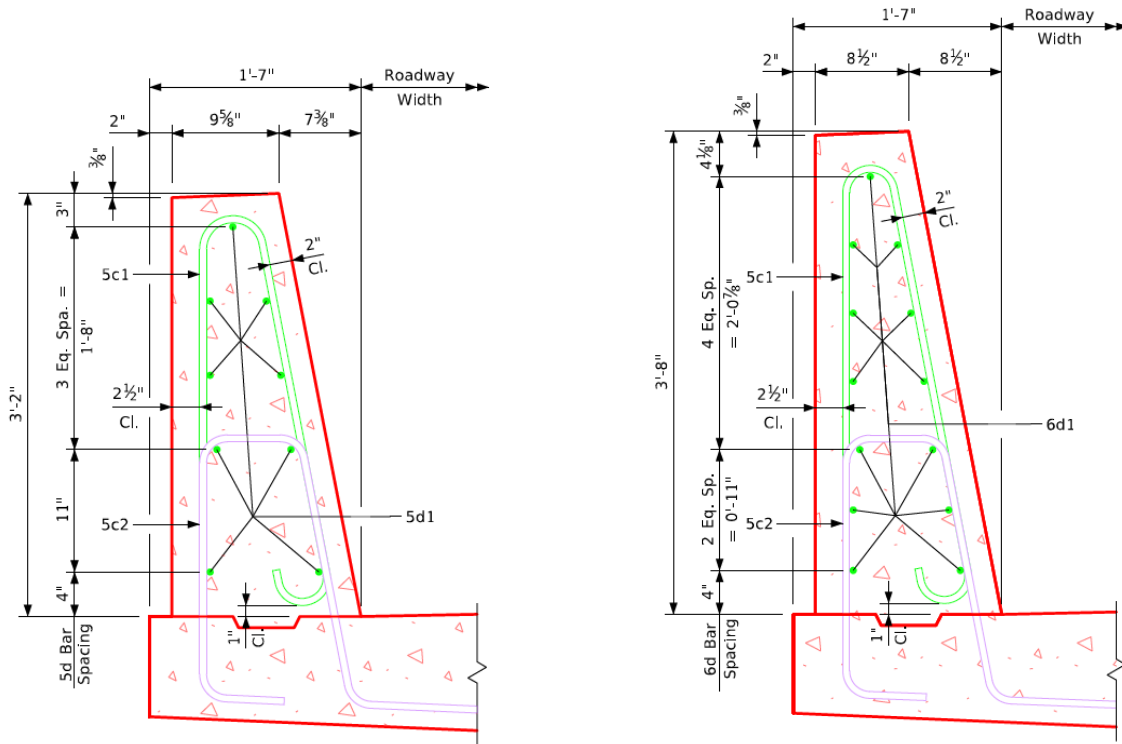

Figure notes:

- In rural interchange bridges one 2-inch conduit is placed in one of the two bridge rails; a second conduit is added if needed. No conduit is placed in other rural bridges.
- In urban bridges conduit is placed in both bridge rails.
- No more than two conduits may be placed in one rail, and the maximum conduit sizes are two 2-inch or one 2-inch and one 3-inch.

Figure 5.8.1.2.1.1. TL-4 and TL-5 single slope barrier rails, respectively

The structural capacity required for MASH compliant rails is greater than that for rails designed according to NCHRP 350. The increase in rail strength also requires a corresponding increase in the strength of the deck overhang. Two approaches were adopted with respect to the c-bar design in the rails to not only accommodate the needed strength increase, but to also limit bar congestion in the rail and deck overhang. First, the c-bar spacing was designed separately for the interior and end regions of the rail such that the c-bar spacing in those regions may be different. Interior regions of the rail may be defined as regions “for impacts within a wall segment” and end regions “for impacts at end of wall or at joint” (AASHTO-LRFD A13.3.1). An end region typically originates at a discontinuity in both the deck and rail as may occur at a deck expansion joint or at a construction joint in the rail where the longitudinal d1 rail bars do not extend through the construction joint. Second, the spacing of the upper c1 bars and lower c2 curb bars may differ from each other in each of those regions. The lower c2 bar spacing is typically greater than the upper c1 bar spacing in cases where the spacing differs. The larger c2 bar spacing helps minimize the reinforcement required in the deck overhang since AASHTO A13.4.2 requires the deck overhang to exceed M_C of the parapet at its base (M_{C-base}). As such, the deck overhang design is based on the strength of the lower c2 curb bars (BDM 5.2.2.4) which are used to determine M_{C-base} . The average strength of the single slope rail (R_w) is based on yield line failure theory from AASHTO-LRFD A13.3.1 using the upper 5c1 bars to determine $M_{C-average}$ for the computation of R_w . This method of satisfying AASHTO requirements is considered valid for two reasons. First the 5c1 bars extend the full height of the rail and are hooked at the base of the front face of the rail which accommodates the transfer of tension

into the 5c2 bars and subsequently into the deck. Second, M_{c-base} of the lower 5c2 bars was designed to be greater than or equal to $M_{c-average}$ of the upper 5c1 bars. Table 5.8.1.2.1.1-2 lists the size and spacing of the c1 and c2 bars for the standard single slope rails. Microsoft Excel applications are available on the Iowa DOT bridge website for determining the strength of the single slope rails and for deck design. See BDM 5.2.2.4 for additional information.

Table 5.8.1.2.1.1-2. c1 & c2 bar size and spacing for MASH TL-4 and TL-5 single slope rails

Bar Designation	TL-4-2 Interior Region	TL-4-2 End Region ⁽¹⁾	TL-5-2 Interior Region	TL-5-2 End Region ⁽¹⁾
Upper c1 bars	No. 5 at 12.00 inches	No. 5 at 9.00 inches for 6.75 feet	No. 5 at 6.00 inches	No. 5 at 4.00 inches for 11.00 feet
Lower c2 curb bars	No. 5 at 12.00 inches	No. 5 at 12.00 inches for 6.75 feet	No. 5 at 9.00 inches	No. 5 at 6.00 inches for 11.00 feet

Table Notes:

(1) The total minimum length needed for the c1 and c2 bar spacing at an end region is based on the critical length, L_c , from BDM Table 5.2.2.4-2. An end region typically originates at a discontinuity in both the deck and rail as may occur at a deck expansion joint or at a construction joint in the rail where the longitudinal d1 rail bars do not extend through the joint. End region lengths for rails in the standards may be longer than the minimum to allow for alignment of the 5c1 and 5c2 bar spacing for interior regions (e.g. IDOT SS 1018S-1 uses a 9-foot end region length).

The standard 9'-5" long bridge rail end sections are typically attached to the top of the abutment wings and provide a transition from the steel guardrails to the single slope rails on the bridge. The standard bridge rail end section is designed for an TL-4-2 end region condition. Prior to adopting MASH, the 7'-0" long standard bridge rail end sections used in conjunction with the F-shape rails had a vertical construction joint between the end section and the F-shape without any of the longitudinal reinforcement passing through the construction joint. With the adoption of MASH, a decision was made to pass the single slope longitudinal rail bars through the construction joint and lap with the end section longitudinal rail bars in the end section. The primary benefit of this change is to maintain continuity in the railing. This is particularly beneficial in cases where there is already a discontinuity in the railing due to an expansion joint at the bridge ends as is the case for stub abutments. A secondary benefit for integral abutments is that the design for the interior region may be extended to the rail end sections since the discontinuity at the construction joint is no longer present.

In most cases TL-4 barrier rails will provide adequate snow plowing splash protection for roadways below the bridge. If BNSF or Union Pacific Railroad tracks are below the bridge, however, Bureau policy is to provide the TL-5 barrier rail as splashboard protection. The rail height should typically remain constant along the full length of the bridge where a TL-5 barrier rail is needed for splashboard protection. The past practice of transitioning rail heights from TL-4 to TL-5 for only the region needing splashboard protection is typically uneconomical for slip-formed barrier rails unless the affected region is 15% or less of the overall bridge length.

In cases where the bridge is near an intersection, sight distance may not be adequate, especially if the barrier rail is taller than the TL-4 rail. The designer should consult with the Design Bureau if barrier rails may restrict sight distance near intersections.

In some situations it may seem desirable to mount a sign support, light pole, or other structure on top of a barrier rail. However, because a vehicle may intrude above and beyond the front face of a single slope barrier, it is preferable to place structures behind the rail. *Guidelines for Attachments to Bridge Rails and Median Barriers and Zone of Intrusion Envelopes Under MASH Impact Conditions for Rigid Barrier Attachments* [BDM 5.8.1.1.5] gives recommendations for intrusion zones based on speed and traffic volume. If it is unreasonable to place structures outside the intrusion zone because of space or cost limitations the designer shall consult with the Design Bureau.

In cases where the railing has a maximum expansion joint opening 4 inches or greater the designer will need to provide steel cover plates [BDM 5.8.1.2.6].

5.8.1.2.1.2 Open

If safety considerations require use of a TL-4 open railing the Bureau recommends use of the railing detailed in Figure 5.8.1.2.1.2. The current open railing details are based on NCHRP 350 requirements. New open railing details based on MASH requirements are in development and will be incorporated at a later date.

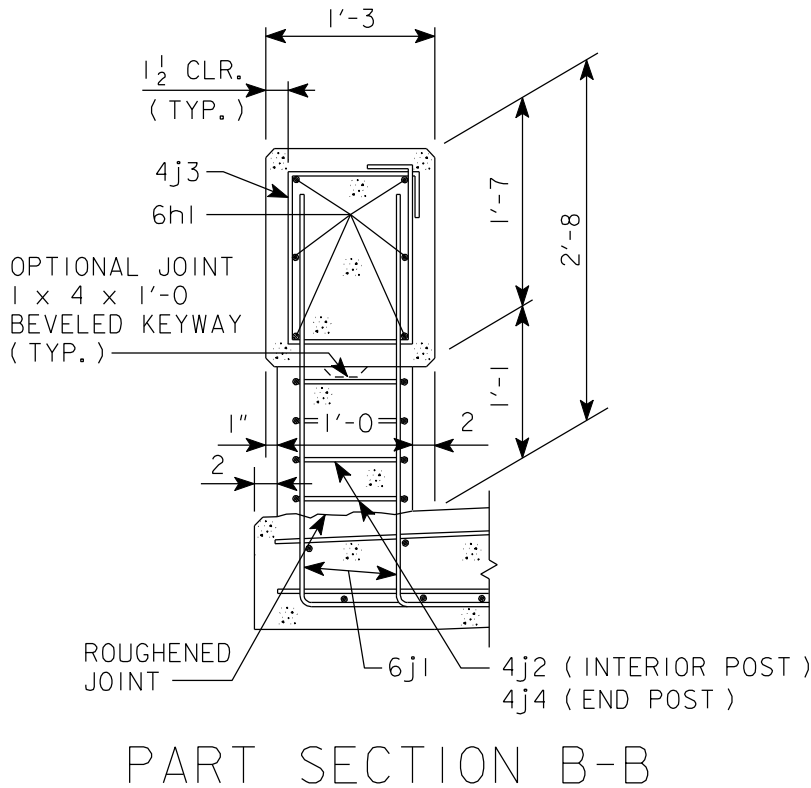

Figure note:

- No more than two conduits may be placed in one rail, and the maximum conduit sizes are two 2-inch or one 2-inch and one 3-inch.

Figure 5.8.1.2.1.2. Open railing rated TL-4 based on NCHRP 350

An open railing should be used only with permission of the supervising Unit Leader.

5.8.1.2.1.3 Retrofit

The Bureau has had the policy of upgrading existing traffic railings or barrier rails that are not NCHRP 350 or MASH compliant to TL-4 as a part of repair, overlay, or paving projects. However, under new policy [BDM 5.8.1.2.1] for deck replacement and widening projects, TL-5 rails may be required for some

conditions. The requirements for retrofit barrier rails are covered in the bridge repair article of this manual [BDM 12.1.9.2.2].

5.8.1.2.2 Pedestrian railings [AASHTO-LRFD 13.8]

The following guidance applies to protection railings at the outside edge of pedestrian sidewalk only, not to the traffic separation barrier. Please refer to BDM 5.8.1.2.4 Separation railings for information related to traffic separators.

Where a sidewalk is provided on a bridge, retaining wall, or adjacent to a culvert headwall, the outer edge of the sidewalk shall be protected with a pedestrian or bicycle railing. The minimum height of the pedestrian railing shall be 42 inches above the sidewalk surface [AASHTO-LRFD 13.8.1]. Taller railings may be appropriate under certain circumstances, such as near schools or playgrounds, or on bridges over high-volume roadways. Iowa DOT standard practice is to use pedestrian railings that are also bicycle height compliant, i.e. 48 inch min. height (BDM 5.8.1.2.3), since some bicycle traffic can be expected to occur on sidewalks that are not trail width-compliant. Horizontal or vertical parts of the railing shall be spaced closely enough so that a 6-inch sphere will not pass through the lower 27-inch portion and an 8-inch sphere will not pass through the portion above the 27-inch height. Any gap at the bottom of the railing shall not allow passage of a 4-inch sphere when any portion of the sphere is within 4 inches of the walking surface (ADA Standards for Accessible Design 405.9.2).

See BDM 5.8.1.2.3 Bicycle railings for an illustrated railing example.

Many local municipalities use the International Building Code (IBC) for setting pass-through requirements for public infrastructure railings. IBC calls for containment of a 4-inch sphere in all parts of a railing. When working on projects within city limits, it is advisable to contact city officials to confirm their expectations of the pass-through requirements being used on the project.

When chain link or metal fabric fence is required, e.g. on some railroad and highway overpasses, pass-through restrictions are more stringent. Chain link or metal fabric fence shall have openings no larger than 2 inches in at least one direction. It sometimes is appropriate to consider the use of smaller chain link mesh openings to discourage climbing of the fence or pushing of objects through the mesh. Smaller mesh openings may be especially appropriate near schools or playgrounds. Chain link mesh is readily available with 1.25 inch x 1.25 inch openings, in aluminum, zinc coated, and vinyl coated products.

For projects involving replacement of existing bridges with pedestrian or bicycle accommodations, it is advisable to take into account the precedent conditions when determining the appropriate pedestrian railing height. Local perception of the level of safety of the replacement railing can be influenced by the type of railing previously used. It is advisable to coordinate the new railing's design with community expectation by making contact with city officials as appropriate.

For bridges over high-volume roadways, it has been the Iowa DOT's past practice to use fence or railing of at least 6 feet in total height, including the parapet if present. A typical minimum height of 6'-6" was used over some interstate facilities that involved new non-standard fence or railing details. Consult the Methods Engineer for appropriate fence or railing height for bridges over interstate highways, or roadways with high (>10,000 VPD) daily traffic counts or high (>45 MPH) posted speeds.

For a railroad overpass the Union Pacific Railroad typically requires an 8-foot tall curved or a 10-foot tall vertical safety fence at the outer edge of a sidewalk. While some railroads have specific written and illustrated requirements for fence configurations, oftentimes fences or railings with characteristics different from those illustrated have been granted railroad approval. It is advisable to coordinate with the railroad or with the Iowa DOT Rail Team in the Modal Transportation Bureau early in the design process to establish the precise fence or railing configuration that will be required on the project.

Design loads for pedestrian railings and fences shall be as given in the AASHTO LRFD Specifications [AASHTO-LRFD 13.8.2].

5.8.1.2.3 Bicycle railings [AASHTO-LRFD 13.9]

The following guidance applies to fall protection railings at the outside edge of bike trail only, not to the traffic separation barrier. Please refer to BDM 5.8.1.2.4 Separation railings for information related to traffic separators.

Where a shared use trail is provided on a bridge, retaining wall, or adjacent to a culvert headwall, the outer edge of the path shall be protected with a bicycle railing. In accordance with the *Iowa Bicycle and Pedestrian Long Range Plan* which contains *Chapter 6: Complete Streets Policy*, the minimum height of the bicycle railing shall be 48 inches above the path surface [AASHTO-LRFD 13.9.2]. The 48-inch height is preferred for all cases except where local conditions favor a taller railing (AASHTO LRFD C13.9.2). Taller railings may be appropriate under certain circumstances, such as near schools or playgrounds, or on bridges over high-volume roadways. Significantly curved bridges or steeply graded bridges may require taller bicycle railings. Horizontal or vertical parts of the railing shall be spaced closely enough so that a 6-inch sphere will not pass through the lower 27-inch portion, and an 8-inch sphere will not pass through the portion above the 27-inch height. Any gap at the bottom of the railing shall not allow passage of a 4-inch sphere when any portion of the sphere is within 4 inches of the walking surface (ADA Standards for Accessible Design 405.9.2).

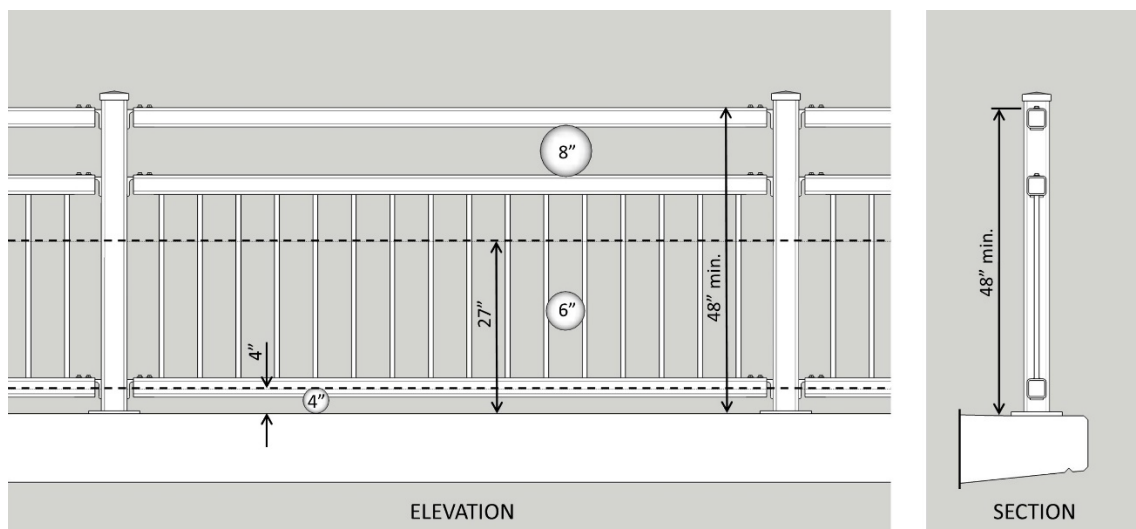

Figure 5.8.1.2.3. Example bicycle railing showing minimum height and pass-through protection requirements (see Project Nos. BRFN-065-7(39)--39-35, Design No. 120 Franklin and BRF-028-2(45)--38-77, Design No. 125 Polk for similar railing applications)

Many local municipalities use the International Building Code (IBC) for setting pass-through requirements for public infrastructure railings. IBC calls for containment of a 4-inch sphere in all parts of a railing. When working on projects within city limits, it is advisable to contact city officials to confirm their expectations of the pass-through requirements being used on the project.

When chain link or metal fabric fence is required, e.g. on some railroad and highway overpasses, pass-through restrictions are more stringent. Chain link or metal fabric fence shall have openings no larger than 2 inches in at least one direction. It sometimes is appropriate to consider the use of smaller chain link mesh openings to discourage climbing of the fence or pushing of objects through the mesh. Smaller mesh openings may be especially appropriate near schools or playgrounds. Chain link mesh is readily available with 1.25 inch x 1.25 inch openings, in aluminum, zinc coated, and vinyl coated products.

For projects involving replacement of existing bridges with pedestrian or bicycle accommodations, it is advisable to take into account the precedent conditions when determining the appropriate bicycle railing height. Local perception of the level of safety of the replacement railing can be influenced by the type of

railing previously used. It is advisable to coordinate the new railing's design with community expectation by making contact with city officials as appropriate.

For bridges over high-volume roadways, it has been the Iowa DOT's past practice to use fence or railing of at least 6 feet in total height, including the parapet if present. A typical minimum height of 6'-6" was used over some interstate facilities that involved new non-standard fence or railing details. Consult the Methods Engineer for appropriate fence or railing height for bridges over interstate highways, or roadways with high (>10,000 VPD) daily traffic counts or high (>45 MPH) posted speeds.

For a railroad overpass the Union Pacific Railroad typically requires an 8-foot tall curved or a 10-foot tall vertical safety fence at the outer edge of a shared use path. While some railroads have specific written and illustrated requirements for fence configurations, oftentimes fences or railings with characteristics different from those illustrated have been granted railroad approval. It is advisable to coordinate with the railroad or with the Iowa DOT Rail Team in the Modal Transportation Bureau early in the design process to establish the precise fence or railing configuration that will be required on the project.

On some projects that include steep slopes or stone revetment alongside the bridge approach trail, or when a bicycle trail is accommodated adjacent to a rock-covered foreslope underneath a bridge, it may be appropriate to extend the application of the bridge's bicycle railing to protect bicyclists from these conditions. It may be necessary to consult the applicable trail authority to determine the necessity of these additional railings. The railing's implications during high water events (where applicable) and on maintenance activities should also be considered. In most cases, bicycle railings placed alongside at-grade conditions such as revetment do not require pass-through protection, so an open railing design could be used. Where bicycle railings are extended onto a bridge approach, provide smooth transitions between railings and avoid abrupt shifts in horizontal railing alignment.

In the past, there has been some debate over the use of continuous horizontal "rub rails" as a feature of bicycle railings or fences along trails. The efficacy of rub rails in preventing handlebar snagging on railings has not been determined through targeted study, nor has the appropriate height and width of such features, when used. The Iowa DOT does not include rub rails on bicycle railings due to these shortcomings of understanding and the lack of specification guidance. It is expected that the bicyclist's tendency to ride at some distance shy of continuous longitudinal obstructions is enough to reduce or prevent handlebar snagging, and that the functional clear width provided for trail surfaces provides the necessary shy distance for safe operation of bicycles.

Design loads for bicycle railings shall be as given in the AASHTO LRFD Specifications [AASHTO-LRFD 13.9.3].

5.8.1.2.4 Separation railings [AASHTO-LRFD C13.7.1.1, 13.10]

Where a bridge provides for pedestrian and/or bicycle traffic in addition to vehicular traffic the designer shall provide appropriate separation between the different streams of traffic. Although a barrier curb may be used for traffic speeds of 45 mph or less [AASHTO-LRFD C13.7.1.1], the Bureau has the policy of providing a separation railing for all but unusual circumstances.

Separator type will usually be determined during the development of the TSL plan. If the separator type has not been determined by the start of Final Design on the project, contact the Methods Engineer for guidance.

Separation barriers shown in this section have either been successfully crash tested to MASH requirements or otherwise meet the Iowa DOT's MASH implementation policy and have been approved for use on Iowa bridge projects.

Standard drawings are not yet available for the three approved separator types described in this section, so it will be necessary to contact the Methods Engineer to obtain the most recent example plans. Note that each of the three separators has a different overall footprint width (10" min. to 15.5" max.).

Coordination with the BSB is essential early in the design process to properly configure the bridge cross section to accommodate the appropriate separator width. Also note that incorporation of aesthetic surface treatments may increase the width of any of the designs.

Iowa DOT standard practice is to use combination traffic and pedestrian railings that are also bicycle height compliant, i.e. 42 inch min. height on the pedestrian side (*AASHTO Guide Specifications for Bridge Railings*) and with a bicycle tube railing, since some bicycle traffic can be expected to occur on sidewalks that are not trail width-compliant. Exceptions must be reviewed and approved by the Methods Engineer.

Separation barriers shall continue at their full height for the length of the bridge deck at a minimum. It is undesirable to terminate a separation barrier within the limits of the bridge deck, as this would result in inadequate crash protection of fence, railing, or abutment features at the bridge corner outside of the sidewalk or shared use path. Sidewalk or shared use path approaches also may be adversely affected by the placement of guardrails attached to separation barriers terminating on or close to the bridge end. The designer shall consult with the Methods Unit in the Design Bureau regarding the appropriate terminus location and configuration for separation barriers to reduce or eliminate safety hazards both for vehicle occupants and for users of pedestrian facilities.

Note that it is typical for the bicycle railing attachments on separators to extend onto the approach barrier beyond the bridge at each end. The full length of these steel railings is typically detailed in the bridge plans. These railings can terminate where the sidewalk or trail alignment tapers away from the back of barrier toward its offset position along the approach. This alignment shift typically occurs at the end of the bridge wing. Also note that pass-through restrictions for fall protection do not apply at separation barriers.

Lighting elements, signs, and other rigid attachments that have not been successfully crash tested must not be mounted to the tops of separation barriers. All necessary rigid attachments must be mounted outside of the ZOI established for the barrier type. For appropriate guidance on minimum setback to lighting, signage, or other obstructions near traffic separation barriers, contact the Methods Engineer.

Drainage of a raised sidewalk or trail is usually accomplished using penetrations through the concrete portion of the separator, sloped toward the gutterline elevation. Drainage of an at-grade sidewalk or trail may involve either draining off the edge of deck or draining through the deck using trench drains that have ADA compliant cover grates. Contact the Methods Engineer for guidance. Draining the roadway through openings in the separator onto an at-grade sidewalk or trail and off the edge of deck is generally undesirable and should be avoided.

IBBR (Iowa Barrier with Bicycle Railing) TL-2 Separation Barrier

Use of the IBBR separator is restricted to roadways with posted speeds of 30 MPH or less and is the preferred separator type for those conditions due to its greater transparency and potential for reducing or eliminating sight distance conflicts, especially in urban areas. The IBBR may not be used on roadways with posted speeds greater than 30 MPH because there is no guardrail or crash cushion option for termination as is required under Iowa DOT Design Manual Section 8A-4. Do not use the IBBR without its bicycle railing without review and approval by the Methods Engineer.

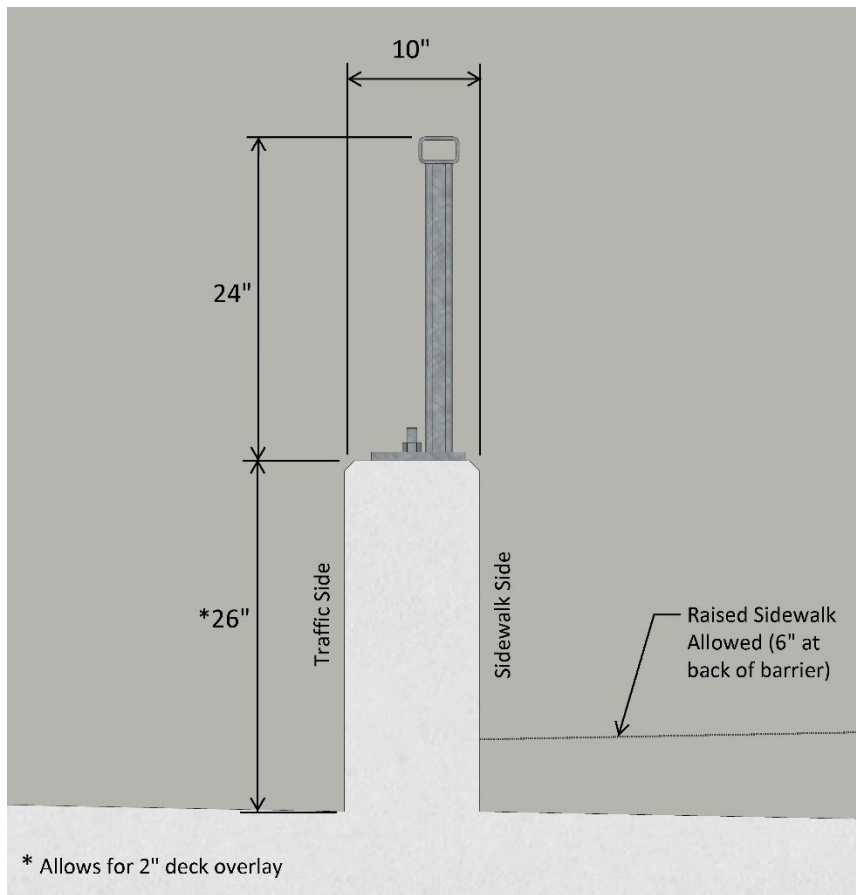

Figure 5.8.1.2.4-1. Iowa DOT "IBBR" TL-2 separation railing (see Project No. BRF-003-6(69)-38-09, Design No. 323 Bremer for a railing application)

MBR (Back-Mounted Bicycle Railing) TL-2 Separation Barrier

Use of the MBR separator is restricted to roadways with posted speeds of 45 MPH or less. At posted speeds of 35 MPH and higher, a guardrail end connection or crash cushion is required under Iowa DOT Design Manual Section 8A-4 unless space restrictions prevent it. If these conditions arise, contact the Methods Engineer for guidance. The MBR may be used in place of the IBBR for lower posted speeds if desired for aesthetic reasons or to meet local municipality expectations or preferences. Check the application for sight distance conflicts before substituting the MBR for the IBBR, and contact the Methods Engineer for guidance. The MBR may be used without its bicycle railing attachment for the traffic-only side(s) of bridges or as a sidewalk separation barrier with review and approval by the Methods Engineer.

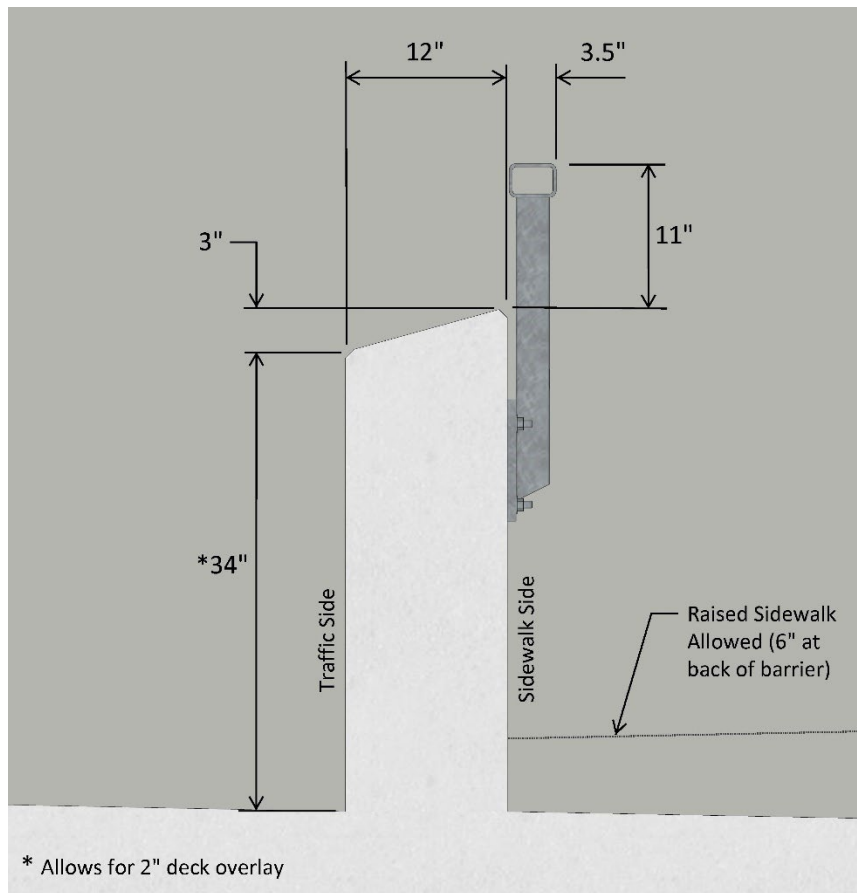

Figure 5.8.1.2.4-2. Iowa DOT “BMBR” TL-2 separation railing (see Project No. NHSX-030-5(277)--3H-85, Design No. 123 Story for a railing application)

Modified B-25 Series TL-3/TL-4 Separation Barrier

Use of the Modified B-25 Series separator is typically reserved for high-speed roadway bridges that include a trail or side path. Bridges carrying roadways with posted speeds greater than 45 MPH must use this design unless there are mitigating circumstances. Contact the Methods Engineer for guidance on possible alternate solutions.

Note that the Modified B-25 Series separator cannot be used with a raised trail on a bridge, since raising the bicycle railing attachment to the required 42-inch minimum height above the trail surface could place it within the barrier’s vehicle intrusion zone. Consider using an at-grade trail on the bridge and warp the trail connection at the ends of the bridge to a curbed approach condition, if necessary.

The Modified B-25 Series barrier may be used in a vehicular traffic-only condition when used on both sides of a bridge that has a sidewalk or trail only along one side. Omit the back-mounted bicycle railing attachment for vehicular traffic-only applications.

The Modified B-25 Series barrier requires guardrail or crash cushion termination in accordance with Iowa DOT Design Manual Section 8A-4.

Combination steel and concrete traffic barrier systems used on Iowa projects must include requirements for embrittlement testing of any cold-rolled and galvanized steel pipes or tubes exposed to traffic loads. Include the appropriate plan notes to cover this testing whenever using the Modified B-25 Series barrier.

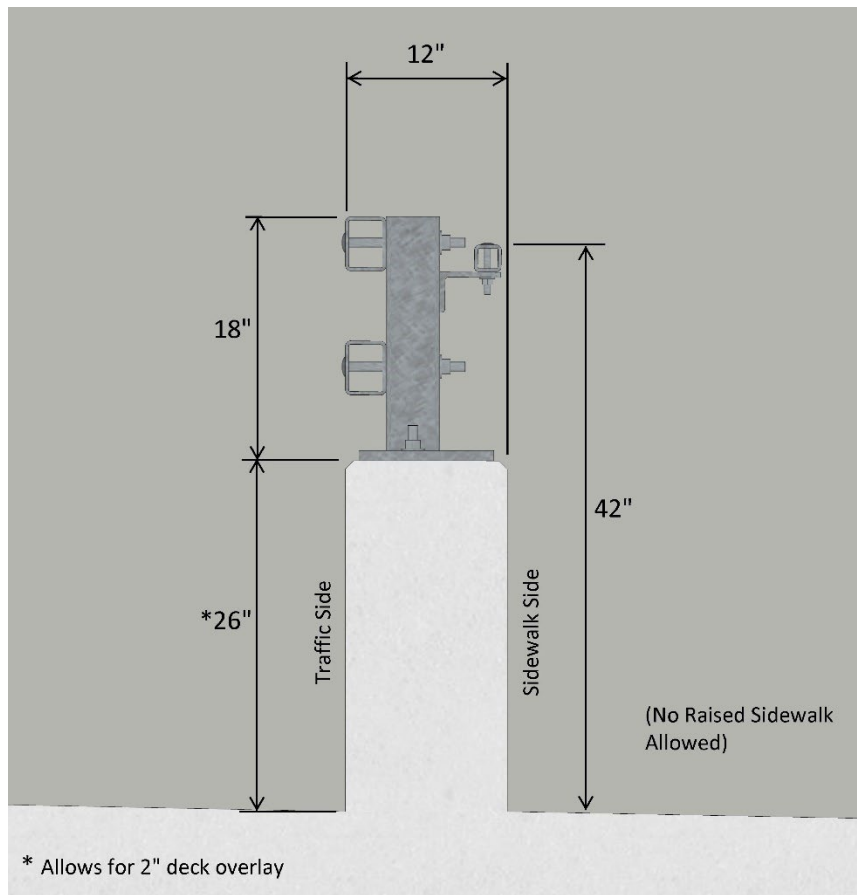

Figure 5.8.1.2.4-3. Iowa DOT “Modified B-25 Series” TL-3/4 separation railing (see Project No. BRF-028-2(45)--38-77, Design No. 125 Polk for a railing application)

5.8.1.2.5 Aesthetic and special railings [AASHTO-LRFD 13.7-13.9]

Bridges that are given special aesthetic treatment usually will include redesign of standard traffic, pedestrian, bicycle, and/or combination railings. Historic bridge replacement projects may require special traffic or pedestrian railings to meet or supplement mitigation requirements. In situations where sight distance considerations apply, such as in or near urban areas, railings may need to be specially designed or selected for better motorist visibility.

Design of pedestrian and bicycle railings and fences generally can be accomplished easily within the rules for geometry and loads in the AASHTO LRFD Specifications [AASHTO-LRFD 13.8, 13.9]. Concrete parapets with aesthetic features may sometimes be used as part of a complete pedestrian/bicyclist fall protection system. Various atypical materials for railing components such as welded wire mesh, perforated metal panels, weathering steel and aluminum may be explored during the design process. Side-mounting of railings to the bridge deck has been used for aesthetic and functional reasons (prevention of weathering steel staining on sidewalk) but is not advised for general use. Duplex coating systems for steel such as polyester powder coating over galvanizing is commonly used and may be considered. However, constructability, material availability and cost are important issues that the designer must also carefully consider. Occasionally, it has been prudent to query each of the DOT’s approved railing fabricators for a constructability evaluation of a unique design prior to advertisement for letting, but this must be done with caution to avoid providing advantage to any single potential bidder. Coordination with other Bureaus is required. Consult the Methods Engineer before considering any contact with fabricators.



Figure 5.8.1.2.5-1. Aesthetic Pedestrian and Bicycle Railing Examples in Iowa

When structures over high-volume roadways or railroads require the use of chain link mesh to limit pass-through, it can be aesthetically desirable to design a picket-style welded railing with traditional 4-inch or 6-inch gaps and attach chain link mesh to the outside face. From many viewpoints, the appearance of this type of system is more like that of a picket railing than of a plain fence and is aesthetically effective. The chain link mesh can be vinyl coated to remain compatible with painted or powder coated framing elements. Vinyl coating color is strictly limited to standard available colors (black, brown, green, white). Chain link mesh with smaller openings than the standard 2"x2" (e.g. 1.25"x1.25") can sometimes be desirable for aesthetics, to discourage climbing of the fence or pushing of objects through the mesh. Smaller mesh openings may be especially appropriate near schools or playgrounds. When chain link mesh fences taller than 6 feet are necessary, use standard available chain link mesh fabric width increments to determine overall system height.



Figure 5.8.1.2.5-2. Example Welded Picket Railing with Chain Link Mesh (project shown is NHSX-100-1(93)—3H-57, Linn. Co. Design No. 915)

Aesthetic design of traffic railings is complicated because of the need to meet a designated *NCHRP Report 350* crash test level [AASHTO-LRFD 13.7] as well as constructability and cost criteria. Appropriate end sections such as SETs [BDM 5.81.1.5] for low-speed conditions or end sections for approach guardrail or crash cushion attachment must also be available for use with the chosen barrier type. Note that Iowa DOT typically adds 2 inches to the height of any crash-tested barrier system to account for future roadway grade raise. Establishment of MASH equivalency for many barrier systems is an ongoing task and may impact the validity of non-standard barrier selections. Consult with the Methods Engineer before considering use of any non-standard traffic railing.

Aesthetic enhancement of a standard single slope concrete barrier is possible in several ways. First, the back (non-traffic) face may receive rustication, form liner texture, projected surfaces, or a combination of these. Most treatments involving manipulation of concrete surfaces will require additional width to be added to the standard barrier footprint. Coloration is also possible using post-applied color coatings on the outside face or throughout the barrier concrete using integral color pigment.

Unless clear concrete cover beyond the established minimum is already present in the barrier section to accommodate surface texture, form liner texturing of the outside face of concrete traffic barriers will require inclusion of additional barrier width equal to or greater than the depth of the texture to maintain the minimum clear concrete cover over near reinforcing. For aesthetic enhancement of the standard single slope barriers, it is essential to maintain the standard reinforcing. Unreinforced outside face projections must not exceed 4 inches of unreinforced concrete, which typically limits projections to 2 inches maximum.

Many types of barrier aesthetic treatment cannot be slip-formed, so the designer must consider the implications of casting barriers in place on the project's cost, constructability, and construction duration. Barrier construction work is often one of the last operations that occurs prior to bridge completion, roadway opening, and the contractor vacating the site. On horizontally curved bridges, cast-in-place forming requirements for barrier aesthetic treatments may represent more significant constructability and cost implications when compared to slip-formed barrier solutions.

Horizontal rustications can be added to the outside face of standard concrete barrier shapes and remain slip-formable, and therefore economical. If typical 1.50-inch wide by 0.75-inch deep V-grooves are used, no increase in clear concrete cover or barrier width is necessary to accommodate the rustications. Integral coloring of concrete barriers has also been successfully employed on Iowa projects, both slip-formed and cast-in-place. Relevant Special Provisions are available from past project work.

The use of post-applied color treatments on traffic faces and tops of concrete barriers is generally discouraged, due to harsh roadway conditions. Salt brine splashing and chemical action, vehicle strikes, and snowplow scraping can have severely detrimental effects on post-applied coloring systems. Barrier top surfaces that have been over-tooled during finishing can exhibit durability problems that become

exaggerated by the presence of post-applied coatings. The outside faces of traffic barriers are generally acceptable surfaces for post-applied color treatments. Special notes are necessary to ensure that no incompatible curing agents or sealers are applied to barrier surfaces intended to receive post-applied coatings. Consult the Methods Engineer before considering barrier coating treatments.

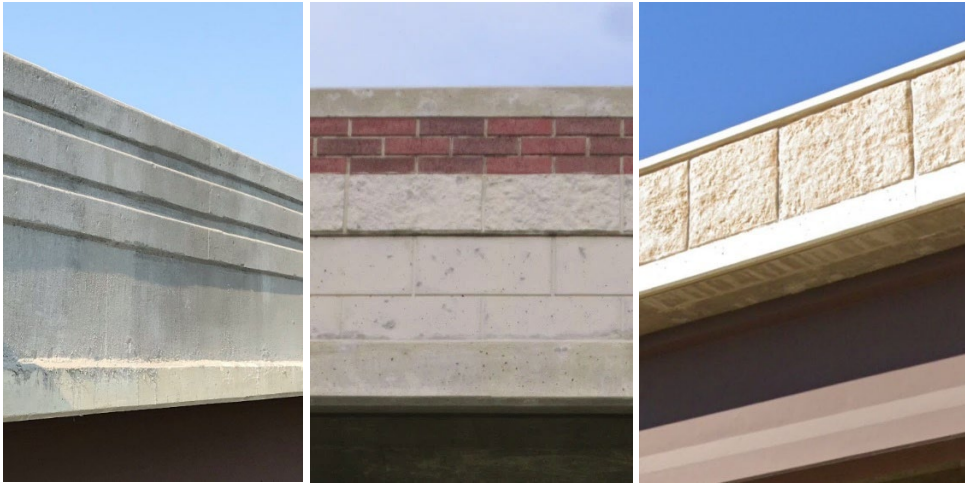

Figure 5.8.1.2.5-3. Examples of Barrier Outside Face Rustication and Texturing

If any part of the traffic face of a barrier contacted by a vehicle is not smooth, it may cause a vehicle to snag, which is undesirable. Therefore, it is necessary to limit rustication depth in barrier faces and chamfer the edges of rustication. See “Acceptance Letter B110: Texture Guidelines for SS and Vertical Concrete Barriers” and *NCHRP Report 554* [BDM 5.8.1.1.5] for further details on acceptable traffic face rustication. Shallow texturing or rustication of the traffic face of some barrier shapes is generally possible when in conformance with the guidance found in these publications. In general, surface rustications up to 0.50-inch deep with beveled edges are acceptable, as are some shallow textures created by form liners. Consult the Methods Engineer before considering barrier traffic face treatments.

Systems for integral thin veneer brick for structural concrete have been used on traffic barriers in Iowa, for both the traffic face and outside surfaces. If used on the traffic side, brick surfaces must generally be kept flush or within 0.50 inch of the untreated traffic face concrete surfaces. Edges of recessed brick zones must be beveled at 45 degrees. On past projects, integral thin brick has been considered part of the clear concrete cover over reinforcing, so no additional barrier width was required for accommodation.



Figure 5.8.1.2.5-4. Examples of Barrier Traffic Face Treatments

The Modified B-25 Series barrier system [BDM 5.8.1.2.4] is a combination steel-on-concrete barrier design that is approved for use up to TL-4 on Iowa projects. Consult the Methods Engineer before considering use. This barrier type can help to preserve views to scenic areas visible from the bridge. Combination steel-on-concrete barrier systems should generally not include painting of the steel components due to the harsh conditions mentioned above. Plain galvanized steel traffic railing surfaces are preferred. When painted steel is used, the Iowa DOT prefers a duplex coating system, i.e. galvanizing with a high-performance paint system such as 3-coat fluoropolymer or polyester powder coating. Consult the Methods Engineer before considering steel traffic railing paint coatings. Note that all combination steel and concrete traffic barrier systems used on Iowa projects must include requirements for ASTM E 436 embrittlement testing of any cold-rolled and galvanized steel pipes or tubes intended for exposure to traffic loads. In addition, epoxy-anchored steel traffic railings typically must refer to the Developmental Specifications for Installing Adhesive-Bonded Anchors and Dowels for Traffic Railings.

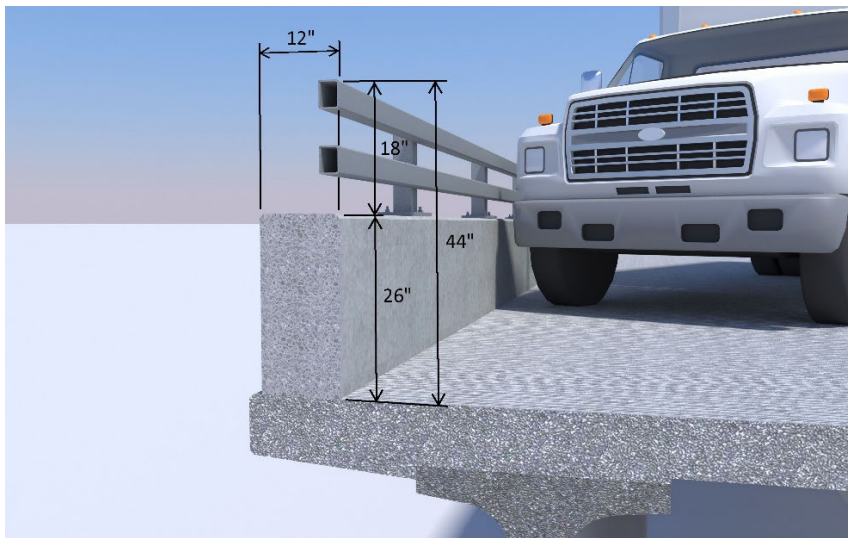

Figure 5.8.1.2.5-5. Modified B-25 Series Barrier

Some Iowa DOT and Local Systems projects located within communities have employed the Texas Classic barrier type, a concrete barrier with many small vertical openings. These are especially popular for historic bridge replacements because the character of these barriers emulates historic concrete barrier styles. Maintenance concerns have been raised about how snow removal equipment may interact with these barriers, and the potential for snow and ice to be pushed through the openings and off the bridge. District maintenance staff should be engaged for feedback on their use. Consult the Methods Engineer before considering use of the Texas Classic barrier type.

The Texas Classic comes in multiple types: 32-inch tall T411 and 42-inch tall C411, both crashworthy to MASH TL-2 conditions or lower. Both versions have multiple vertical openings that are formed by standardized liner components that are readily available to contractors. Some Iowa contractors have experience in constructing the Texas Classic barrier types. When used as a separation barrier, the overall height must be raised, and the lower segment (below the windows) increased to maintain ADA compliance at the base of the barrier along a raised sidewalk. Consult the Methods Engineer for example details. A steel bicycle railing attachment is generally not possible for this barrier type, so usage as a trail separator is discouraged since it would require a Design Exception process.

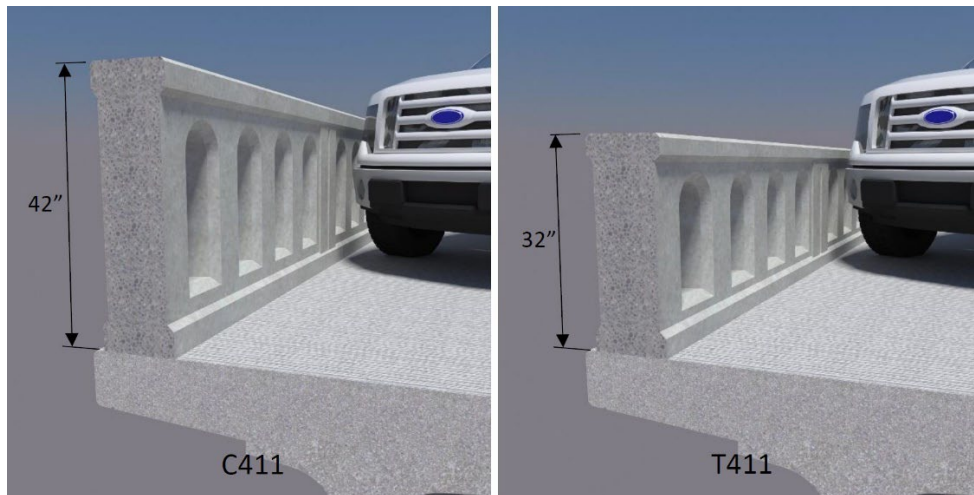

Figure 5.8.1.2.5-6. Texas Classic Barriers C411 and T411

The bicycle railing attachment on the IBBR separation barrier system [BDM 5.8.1.2.4] can be enhanced only by using a duplex coating system such as powder coating or 3-coat fluoropolymer paint over galvanizing, but this is discouraged in most cases due to the harsh roadway conditions previously mentioned in this section. The IBBR steel railing details must remain identical to the crash-tested version. The bicycle railing attachment on the BMBR separation barrier system [BDM 5.8.1.2.4] can be enhanced by a coating or by manipulation of the railing component shapes, provided the railing remains at least 12 inches from the traffic face of the barrier and projects no more than 4 inches into the sidewalk/trail.

Attachment of non-crash-tested metal railings, fences or other features for the purpose of ornamentation or decoration is not allowed within a traffic barrier's Zone of Intrusion [BDM 5.8.1.1.5] for the posted speed. For the current ZOI limits for all barrier Test Levels see NCHRP Report 1018, Zone of Intrusion Envelopes Under MASH Impact Conditions for Rigid Barrier Attachments [BDM 5.8.1.1.5]. If the posted speed differs substantially from the barrier's test conditions, it may be possible to reduce the effective ZOI through engineering judgment or analysis. Consultation with the Methods Engineer is required to establish the effective ZOI in these cases. Mounting of the decorative feature(s) to the back side of the traffic barrier may locate the feature entirely outside of the barrier's ZOI in some cases. The mounting of such attachments must not negatively affect the barrier's structural performance and increase the maintenance burden on the structure. Agreements between the Iowa DOT and the local municipality or other authority are often required to establish funding and maintenance responsibilities for such attachments on State-owned structures.

5.8.1.2.6 Concrete railings

Concrete railings shall be placed either by the slipform method with Class BR concrete [IDOT SS 2513.03, A, 2] or by the cast in place method with Class C concrete. Due to quality issues, Class D concrete no longer is permitted for placing rails by either method. The designer shall include general note E188 [BDM 13.3.2] on the plans. Bid item reference information designates permissible concrete class.

Relatively wide expansion joints in concrete barrier railings require steel cover plates. The designer shall provide cover plates whenever the maximum expansion joint opening is 4 inches or greater. Details shall be as follows:

- The entire barrier rail joint opening (front and back) shall be covered by a galvanized steel plate with a minimum thickness of 3/8 inch and shall extend a minimum of 9 inches past the expansion opening. Larger plate thicknesses should be considered for openings greater than 6 inches.
- The plate shall be fabricated to conform to the front face of the barrier including the top. In addition, a separate back plate shall be used that meets the front plate at the top of the barrier rail.

- The joint where the two plates meet shall be sealed with light gray non-sag latex caulking sealer marketed for outdoor use.
- The exterior face of the plates shall be recessed $\frac{1}{4}$ inch below the surface of the rail to reduce potential for snagging. Plates shall be detailed so that traffic passes the attached ends first and in passing cannot snag the sliding ends.
- The cover plate will allow for the full thermal movements required at that joint location plus any setting factors that are required for the joint.

For cover plates on pedestrian, bicycle, separation, and aesthetic railings the designer shall consult with the supervising Unit Leader and Aesthetic Specialist.

5.8.1.3 Temporary barrier railings

For staged construction the Design Bureau usually is responsible for layout of temporary barrier rail (TBR). The Bridges and Structures Bureau generally provides input on the placement of the TBR with respect to the deck cross-section. The TBR may be either concrete or steel, but the Bureau does not permit the use of a combination of both types of rail in the same installation. Additional information on the use of TBR is given in a bridge repair article of this manual [BDM 12.1.8.3].

5.8.1.3.1 Concrete

Concrete temporary barrier rail is detailed on several Design Bureau standard road plan sheets [DB SRP BA-401]. The standard rail has a double F-shape, a 32-inch height, and 12.5-foot lengths.

Typical layout of the rail for one-way and two-way traffic is shown on standard sheets [DB RDD 8210, 8212]. Details of the placement policy are given elsewhere in this manual [BDM 12.1.8.3].

Rules for use of tie-downs are given in the Design Bureau's design manual [DB DM 9B-9] and on a standard sheet [DB SRP BA-401].

5.8.1.3.2 Steel

Steel HP 14x73 temporary barrier rail is composed of two pile sections welded flange tip to flange tip, with a concrete fill [DB DM 9B-9, DB SRP BA-400, and DB RDD 560-07]. The height of the cross section is 29.25 inches, and the length of a rail section is 20 feet.

Typical layout of the rail for one-way and two-way traffic is shown on standard sheets [DB RDD 8210, 8212]. Details of the placement policy are given elsewhere in this manual [BDM 12.1.8.3].