

Bolt Loosening Retrofit to Inhibit Fatigue Cracking in Steel Girder Bridges

Keywords: Multiple Girder Steel Bridges, Web Gap Fatigue, Differential Displacement

D.J. Tarries
Iowa State University
Graduate Research Assistant
6213 SW Beaverton Hillsdale Hwy., Apt. 201
Portland, Oregon 97221
(503) 292-2250
dtarries@hotmail.com

B.M. Phares
Iowa State University
Associate Manager, Bridge Engineering Center
2901 South Loop Drive
Suite 3100
Ames, Iowa 50010
(515) 294-5879
Fax: (515) 294-0467
bphares@iastate.edu

T.J. Wipf
Iowa State University
Pitt-Des Moines Professor of Civil Engineering
420 Town Engineering Building
Ames, Iowa 50011
(515) 294-6979
Fax: (515) 294-7424
tjwipf@iastate.edu

L. Greimann
Iowa State University
Civil and Construction Engineering Department Chair
390 Town Engineering Building
Ames, Iowa 50011
(515) 294-5586
Fax: (515) 294-8216
greimann@iastate.edu

D.L. Wood
Iowa State University
Structures Laboratory Manager
136 Town Engineering Building
Ames, Iowa 50011
(515) 294-3768
Fax: (515) 294-7424
dwoody@iastate.edu

WORD COUNT = 5,820

A paper submitted to the Transportation Research Board for presentation and publication.
November 15, 2002

ABSTRACT

Many of Iowa's multiple steel girder bridges have shown signs of fatigue cracking due to out-of-plane displacement of the web in the region of the diaphragm connections. The fatigue-prone web gap area is located in the negative moment regions where the diaphragm stiffeners are not attached to the top flange. The Iowa Department of Transportation (Iowa DOT) has tried various retrofit methods to stop fatigue crack propagation with limited success. They requested research on a new field retrofit to loosen the bolts in the connection between the diaphragm and the girders. The intent of this research was to show that loosening the bolts at the diaphragm/girder connection is effective in reducing strain in the web gaps.

Selected web gaps in the negative moment region on several highway bridges were instrumented with strain gages and deflection transducers to measure out-of-plane displacement. Field tests, using loaded trucks of known weight and configuration, were conducted before and after implementing the bolt loosening retrofit. In addition, long-term monitoring of one bridge indicated that no degradation in performance of the retrofit occurred. Results indicate that loosening the diaphragm bolts reduces out-of-plane displacement and strain in the web gap. The reduction in strain is likely related to less fatigue in the web gaps and a probable increase of service life of the bridges.

INTRODUCTION

The Iowa Department of Transportation (Iowa DOT) has encountered many instances of fatigue in steel girder bridges caused by typical traffic loading. Many of Iowa's 908 steel girder bridges have been in service for more than 30 years and signs of age are beginning to appear. Sixty-three of those bridges are considered fracture critical. Approximately 55 percent of the fracture critical bridges have developed fatigue cracks in the girder webs at connections with the diaphragms. This is especially true for interstate bridges where the frequency of loading, especially truck loading, is greater. The loads are within legal limits for the structure, but over time fatigue stress accumulates.

In the 1980's the Iowa DOT began using a drilled hole retrofit at the terminus of fatigue cracks in an attempt to slow the propagation of the cracking by changing the stress condition at the tips (1-6). However, the retrofit has not always been successful in controlling fatigue cracking. The lack of success could be the result of two conditions; 1) The hole may not have been drilled at the actual crack terminus due to difficulty in visually identifying this point, and 2) The stress levels created in the web may be too great to be controlled by the drilled hole retrofit. The result in both cases is continued crack growth.

Regardless of the cause of continued cracking in steel girder bridges, the Iowa DOT initiated research on other techniques for controlling web gap cracking. In the 1990's research was conducted at Iowa State University on a new retrofit based on reducing the cause of the fatigue cracking in the web, rather than controlling the symptom (7-9). The new retrofit involved loosening the bolts at the diaphragm/girder connections in the negative moment region. Testing of the retrofit was carried out through short-term field-testing of K-type and X-type diaphragm bridges (8,9). Results of the tests were positive, showing a reduction of the strain in the web gaps, however the tests only encompassed a few types of diaphragms over short periods.

Work described herein focuses on expanding the application of the retrofit to other diaphragm types as well as long term performance monitoring. Field-testing was performed on an I-beam diaphragm bridge and a channel diaphragm bridge. Long-term monitoring was completed on an X-type diaphragm bridge, which was part of the original study, to investigate the viability of the retrofit over time.

DESCRIPTION OF FATIGUE PROBLEM AND RETROFIT

Differential deflection of the girders under traffic loading causes bridge diaphragms, rigidly connected to the girder web stiffener, to distort in double bending (1-6, 10-15). Double bending of the web increases with the magnitude of the traffic load and average truck loading, within legal limits, has proved significant enough to create this condition. The bending in the diaphragms creates a rotational force that is resisted at the connection with the girders.

Theoretically fatigue cracking due to this rotational force can occur in the girder web, web stiffener, or the diaphragm itself. Bridges in Iowa have typically exhibited cracking in the web resulting from a lack of connection between the girder top flanges and the web stiffeners. The problem area, commonly referred to as the "web gap", is between the top of the web stiffener fillet welds and the top flanges in the negative moment regions. The web stiffeners carry lateral load effectively, but can place significant out-of-plane loading on the webs. The web gaps displace out-of-plane as illustrated in Fig. 1a which shows double bending of a web gap resulting from out-of-plane loading on the web. A typical fatigue crack, along with a drilled hole retrofit resulting from the phenomena is shown in Fig. 1b.

The bolt loosening retrofit has been devised to eliminate the force induced in the diaphragms by differential displacement. The loose bolts in the diaphragm/girder connections effectively create a pinned connection between the two. This connection allows for slight rotation of the diaphragms, which occurs when the girders deflect differentially, without placing out-of-plane forces on the webs. Removing the diaphragms completely, though a possibility in many cases, may leave the structure unstable, and generally is not a desirable solution. Retaining the loose connection of the diaphragms permits the diaphragm to function in extreme situations, e.g., in a catastrophic event, that might involve significant lateral displacement of the girders. In other words, if the girders experience significant lateral deflection, the bolts in the connections will move into bearing and the diaphragms will engage to provide stability to the bridge.

TEST BRIDGES

Three bridges were instrumented to evaluate the diaphragm bolt loosening retrofit. Short-term tests were performed on a channel diaphragm bridge on Interstate 35 and an I-beam diaphragm bridge on Interstate 80. Both bridges were selected for evaluation because of their heavy truck traffic volume and because they had already exhibited fatigue

cracking. The third bridge was an X-type diaphragm bridge that was tested for long-term effectiveness of the retrofit. The bridge was selected because it was part of the original short-term retrofit research of X-type diaphragm bridges and because it had no known fatigue cracking.

The I-beam Diaphragm Bridge, shown in Fig. 2a, is a two lane, three span, multiple steel girder bridge on Interstate 80. The bridge cross section, with diaphragms, is shown in Fig. 2b. I-shaped diaphragms, spaced at approximately 20 ft, provide lateral support to the girders. Figure 2d shows a plan view of the superstructure, which is skewed at 10 degrees. The five 48 in. deep welded plate girders support an 8-in. concrete deck that is integral with the top flange. The bridge has multiple examples of web gap fatigue cracking near diaphragm connections in the negative moment region. The webs with visible cracks have had holes drilled in the web following crack identification. The high occurrence of fatigue cracking in this bridge makes it a critical bridge for fatigue and a prime specimen for retrofit testing. The diaphragms are bolted to vertical stiffeners as illustrated in Fig. 2c. The vertical stiffeners are welded to the web and the compression flange of the girder. In the negative moment region above the piers, the top flange is in tension and is not welded to the stiffeners. A web gap of about 1 in. in the vertical direction exists between the top of the stiffener weld and the bottom of the girder top flange where the stiffener is clipped. As noted previously, fatigue cracks have occurred in this region.

The Channel Diaphragm Bridge on Interstate 80 is a multiple steel girder bridge similar to the I-beam Diaphragm Bridge except it has channel diaphragms connecting the five girders. It is a three span structure with five 38 in. steel girders supporting an 8-in. concrete deck shown in Fig. 3a. The bridge is skewed 40-degrees as shown in Fig. 3c. The girders are spaced at 9 ft-6 in. as illustrated in Fig. 3b. The channel diaphragms are rolled 18C42.7 sections. The X-type Diaphragm Bridge on Iowa Highway 17 is a five-girder bridge, shown in Fig. 4a, with X-type diaphragms, similar to the I-beam Diaphragm Bridge with the exception of the diaphragms and the 62 in. girder depth. Figure 4d shows a plan view of the bridge. The diaphragms in this bridge are an X-type diaphragm made up of angles and a horizontal T section as illustrated in Fig. 4b. The angles are L4x3x5/16 and the T is an ST5WF10.5 and are bolted to web stiffeners on the main girders as shown in Fig 4c.

INSTRUMENTATION

Each of the three bridges was fitted with an array of strain gages and displacement transducers to measure the impact of the retrofit on bridge performance. Strain gages were placed in the web gaps at locations between interior and exterior girders. Strain gages were also placed on the diaphragm at various locations between the interior and exterior girder to monitor the impact of the retrofit on diaphragm behavior. Displacement transducers were mounted at the web gap to measure out-of-plane displacement. The I-beam Diaphragm Bridge is described in detail in the following paragraphs as the typical instrumentation set up. Specific information on the instrumentation for each of the bridges can be found in (1).

Instrumentation locations on the I-beam Diaphragm Bridge are shown in Fig. 5. Bondable 120-Ohm gradient strain gages were used to measure strain distribution in the web gap, which were important in determining the effectiveness of the diaphragm connection retrofit. The gradient gages consisted of three to five small foil backed strain gages factory assembled in a very small unit. They were mounted in, or as close to, the web gap as possible as seen in Fig. 6a.

Direct Current Displacement Transducers (DCDT's) were used to measure displacement of the web gaps. They were attached by magnetic stands to the girder webs and flanges at the connections with the diaphragm as shown in Fig. 6b. The interior and exterior girders each had a DCDT for out-of-plane displacement measurement. The gage measured out-of-plane displacement of the web by measuring the horizontal displacement of the web stiffener relative to the top flange.

Gages were placed at the mid and quarter points of the diaphragm between the exterior and interior girder on the top and bottom flanges as shown in Fig. 6c to measure the change in force due to the retrofit for the X-type Diaphragm Bridge, which had X-type diaphragms. A gage was placed at the quarter point of each of the three diaphragm members.

Data from all gages were collected using a data acquisition system (DAS) and recorded for the I-beam Diaphragm and the Channel Diaphragm Bridges. The X-type Diaphragm Bridge utilized an entirely different system that was specifically designed to remain in the field for long periods of time and collect ambient field performance data.

TEST PROCEDURE

All three bridges were tested using Iowa DOT standard 3-axle load trucks with a standard wheel pattern. The load trucks weighed approximately 50,000 lbs. and crossed the bridges at speeds comparable to ambient traffic, or

between 55 and 65 mph. Tests were run with trucks in different positions on the bridge deck, but the most substantial results were recorded for each bridge when loading was in the lane directly above the instrumentation. Testing of the bridges took place in two different test passes. Test trucks or truck crossed the bridge with the bolts in the tight and loose conditions. A pass was completed with the bolts in the tight condition, after which the bolts in the diaphragm were loosened. It should be pointed out that the bolts in the instrumented diaphragm as well as the adjacent interior diaphragm were loosened to ensure that the instrumented diaphragm and web gap were free of forces applied from nearby diaphragms. Following bolt loosening a second test pass with trucks of either the same or similar weights crossed the bridge. Test passes were recorded to include data of approximately 15 seconds, enough time for the load trucks to completely cross the bridge.

Bolts were loosened in the instrumented diaphragm and in the diaphragm in the adjacent bay to ensure isolation of the instrumented diaphragm. Loosening the bolts consisted of backing off the nut a fraction of an inch to allow the diaphragm a small amount of rotation.

In addition to the controlled load tests described previously, testing of the X-type Diaphragm Bridge included ambient traffic data as well. The long-term data collection system allowed continuous monitoring of the bridge over a few months with the bolts tight and loose.

RESULTS

The general trend of the results was similar in all three bridges. Individual strain and displacement values differed due to different bridge geometries, but the patterns of strain and displacement were consistent. This suggests that the web gap phenomena studied may react in a similar manner on other multiple steel girder bridges. In short, all three bridges showed significant reductions in strains and displacements following implementation of the retrofit. The results from testing of the three bridges are described below.

Typical web gap strains in the I-beam Diaphragm Bridge for both the tight and loose bolt conditions are shown in Fig. 7a. A strain reduction of approximately 80 percent occurred due to bolt loosening. It should be pointed out that the strain of the web gap on this bridge could not be measured directly in the web gap due to the presence of fatigue cracks and two drilled hole retrofits. The gages were positioned to the side of the gap away from the holes. As a result, the strains measured are smaller than they would be otherwise. Figure 7b depicts the out-of-plane displacement of the web gap on the I-beam Diaphragm Bridge with the bolts tight and loose. A similar reduction of approximately 75 percent occurs when loading is in the lane above the diaphragm. The bending strain in the diaphragm is shown in Fig. 7c. The strain in the diaphragm reduces almost completely when the bolts are loose. This suggests that the forces created in the diaphragm due to differential deflection are released by the retrofit. Figure 8a shows the web gap strains for the Channel Diaphragm Bridge. Web gap strain reduction with the bolts loose is over 80 percent. The out-of-plane displacement of the web gap with the bolts tight and loose is shown in Fig. 8b and was reduced by nearly 80 percent with the bolts loose. The web gap strain and the out-of-plane displacement appear closely linked, as expected. Strain reductions in the channel diaphragm are plotted in Fig. 8c. The strain in this diaphragm is nearly eliminated, as was the case with the I-beam, again suggesting the forces in the diaphragm are removed.

Web gap strains of the X-type Diaphragm Bridge are plotted in Fig. 9a. The strain reduction due to the retrofit in this bridge is approximately 80 percent. As before, Fig. 9b shows the out-of-plane displacements in the web gap with the bolts in both conditions. The displacement reduced nearly 70 percent with the bolts loose. It should be noted that, due to inaccessibility, the bolts in the exterior side of the horizontal member were not loosened and the results may be somewhat effected, as suggested by Fig. 9c. The strain in the diaphragm members were not completely eliminated when the bolts are loose, possibly due to the bolted horizontal member; however, the reduction is nearly 100 percent and still shows the effectiveness of the bolt loosening.

As previously noted, the X-type Diaphragm Bridge was also tested for long-term changes in strain and displacement using ambient truck traffic crossing the bridge for three months with the bolts tight and three months with the bolts loose. Ambient traffic was calibrated to the load tests by the bending strain magnitudes in a longitudinal girder. The bending strain in the interior girder from the DOT truck loading with the bolts in both positions is shown in Fig. 9d. It is important to note that the test truck crossing with the bolts tight was slightly heavier than the truck in the tight bolt test. The percentage difference in loading is similar to the percentage difference in peak strain. Since the longitudinal girder strain was not greatly affected by the bolt condition, data from this gage could be normalized and used to compare truck loads. This also suggests that there is minimal load redistribution between the girders when the diaphragms are loose. Similar girder instrumentation on the other two bridges displayed the same behavior before and after bolt loosening. Stallings et al. also researched load redistribution in multiple girder bridges

following removal of the diaphragms (10-15). Their work suggested a 5 to 15 percent change in strain in the most heavily loaded girder following diaphragm removal.

A sample of trucks similar in loading to the DOT trucks versus maximum web gap strain is shown in Fig. 10, one typical truck from each month of testing. The maximum web gap strains with the bolts in each position are similar enough to develop a trend in strain that appears unaffected by time.

Stability of the bridge girders was not specifically addressed in this paper. However, American Association of State Highway and Transportation Officials (AASHTO) design specifications were consulted regarding girder stability as suggested by other researchers (16,17). The calculations revealed the bridges were sufficiently stable without the diaphragms. However, further research could be performed on this matter.

IMPLEMENTATION ISSUES

Results have shown that implementing the bolt loosening retrofit on multiple steel girder bridges is a viable solution to web gap fatigue cracking. However, before this retrofit is installed in in-service bridges, a few key points must be addressed on a case-by-case bridge basis.

First, lateral support for the girders and overall stability of the structure with the diaphragms loosened may be a concern when installing the retrofit. Bracing for lateral torsional buckling is important in the negative moment region and generally the larger girders in the negative moment region generally provide adequate support for the unbraced length. However, each bridge should have calculations performed to ensure stability. More than likely, even if girder stability was found to be deficient installation of the retrofit would not jeopardize the integrity of the structure because the diaphragms can still engage to provide lateral support between girders if significant lateral movement occurs.

Second, lateral load distribution should also be addressed. The change in lateral load distribution of the bridge was not thoroughly investigated, but other researchers (10-15) have found that most bridges are conservatively designed for lateral load distribution and show little change in lateral load distribution with the diaphragms removed.

Loosening the bolts in the diaphragm/girder connections is equivalent to, or less than, removing the diaphragms all together when considering lateral load distribution.

Third, a system must be devised to ensure that the loose bolts remain in place. The bolts must be secured so that they do not inadvertently fall out due to vibration. The method of connection was not researched, but a lock nut or double nut technique may be a solution. Any solution should be periodically inspected to ensure that it is functioning properly.

CONCLUSIONS

The short-term testing of all three bridges shows that the bolt loosening retrofit is effective in reducing live load web gap strain and out-of-plane displacement that may contribute to fatigue cracking in web gaps. A reduction of the strain and displacement as noted in this study (on the order of 75 percent) could reflect a significant reduction of the cumulative fatigue in the web gap. Long-term testing showed that the strain reductions remained stable over time. While the general results of the bolt loosening retrofit were not surprising, the results did not identify any complications with the retrofit which helps to support the future application of the retrofit on in-service bridges.

REFERENCES

1. J.W. Fisher. Fatigue and Fracture in Steel Bridges, Case Studies. New York: John Wiley and Sons, 1984.
2. J.W. Fisher, B.T. Yen, and D.C. Wagner. "Review of Field Measurements for Distortion Induced Fatigue Cracking in Steel Bridges." Transportation Research Record, No. 1118, pp. 49-55, Washington, D.C.: TRB, National Research Council, 1987.
3. J.W. Fisher, and P.B. Keating. "Distortion-Induced Fatigue Cracking of Bridge Details with Web Gaps." Journal of Constructional Steel Research, Vol. 12, pp. 215-228, ASCE, 1989.
4. J.W. Fisher. Executive Summary: Fatigue Cracking in Steel Bridge Structures. Bethlehem, Pennsylvania: Advanced Technology for Large Structural Systems, Report No. 89-03, Lehigh University, 1989.
5. C.E. Demers, and J.W. Fisher. A Survey of Localized Cracking in Steel Bridges 1981 to 1988. Bethlehem, Pennsylvania: Advanced Technology for Large Structural Systems, Report No. 89-01, Lehigh University, 1989.
6. P.B. Keating. "Focusing on Fatigue." Civil Engineering, Vol. 64, No. 11, pp. 54-57, New York: ASCE, 1994.
7. D. Tarries. "Diaphragm Bolt Loosening Retrofit for Web Gap Fatigue Cracking in Steel Girder Bridges", Thesis, Iowa State University, Ames, Iowa, 2002.
8. T.J. Wipf, and L.F. Greimann, A. Khalil. Preventing Cracking at Diaphragm/Plate Girder Connections in Steel Bridges. Ames, Iowa: Center for Transportation Research and Education, Iowa DOT Project HR-393, Iowa State University, 1998.
9. A. Khalil. "Aspects in Nondestructive Evaluation of Steel Plate Girder Bridges", Dissertation, Iowa State University, Ames, Iowa, 1998.
10. T.E. Cousins, and J.M. Stallings. "Calculation of Steel Diaphragm Behavior", Journal of the Structural Division, Vol. 102, No. ST7, pp. 1411-1430, ASCE, July 1976.
11. J.M. Stallings, and T.E. Cousins, and T.E. Stafford. "Effects of Removing Diaphragms from Steel Girder Bridge", Transportation Research Record, Vol. 1541, pp. 183-188, Washington, D.C.: TRB, National Research Council, 1996.
12. J.M. Stallings, and T.E. Cousins. "Fatigue Cracking in Bolted Diaphragm Connections." Proceedings of the 15th Structures Congress 1997 Portland, Vol. 1, pp. 36-40, New York: ASCE, 1997.
13. J.M. Stallings, and T.E. Cousins. "Evaluation of Diaphragm Requirements in Existing Bridges." Proceedings of the 15th Structures Congress 1997 Portland, Vol. 2, pp. 1494-1498, New York: ASCE, 1997.
14. T.E. Cousins, and J.M. Stallings. "Laboratory Tests of Bolted Diaphragm-Girder Connection." Journal of Bridge Engineering, Vol. 3, No. 2, pp. 56-63, ASCE, May 1998.
15. T.E. Cousins, J.M. Stallings, and T.E. Stafford. "Removal of Diaphragms from 3-Span Steel Girder Bridge." Journal of Bridge Engineering, Vol. 4, No. 1, pp. 63-70, ASCE, Feb. 1999.
16. A. Azizimini. "Steel Bridge Design Using AASHTO LRFD Bridge Design Specifications (1999 Interim)." Proceedings of National Bridge Research Organization Short Course, Kansas City: NaBRO, November 1999.
17. A. Azizimini, S. Kathol; and M. Beachman. "Effects of Cross Frames on Behavior of Steel Girder Bridges." 4th International Bridge Engineering Conference Proceedings, pp. 117-124, Washington, D.C.: TRB, 1995.

LEGEND TO FIGURES

Figure 1: Typical web gap condition.9
 Figure 2: Bridge 5075.5R080 layout.11
 Figure 3: Bridge 2700.0R035 layout.13
 Figure 4: Bridge 4048.2S017 layout.15
 Figure 5: Typical plan view of gage placement (bridge 5075.5R080 shown).16
 Figure 6: Typical instrumentation.18
 Figure 7: Bridge 5075.5R080 test results.20
 Figure 8: Bridge 2700.0R035 test results.22
 Figure 9: Bridge 4048.2S017 test results.24
 Figure 10: Maximum exterior web gap (G12G) strains and longitudinal girder strains for individual truck loadings
 on bridge 4048.2S017.25

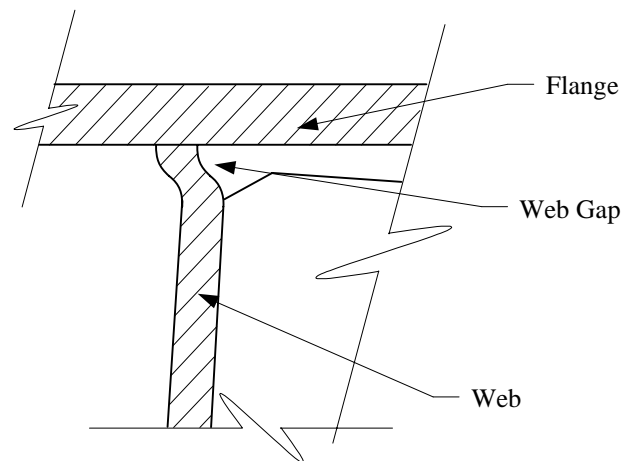

a. Web gap double bending.



b. Typical drilled hole retrofit in a web.

Figure 1: Typical web gap condition.



a. Bridge 5075.5R080 looking northwest.

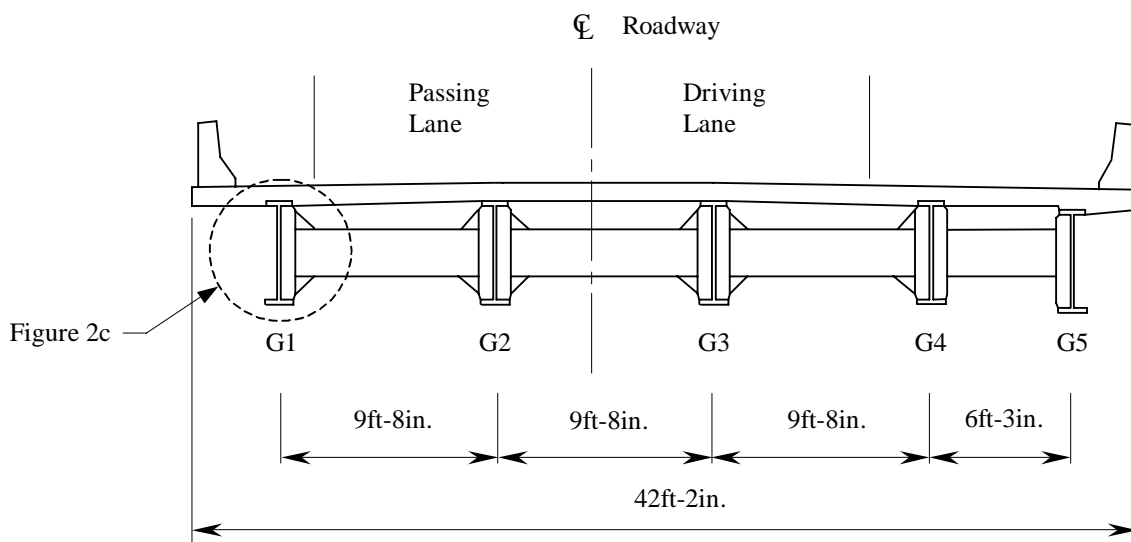

b. Bridge 5075.5R080 cross section looking toward direction of traffic.

Figure 2: Bridge 5075.5R080 layout (cont.).

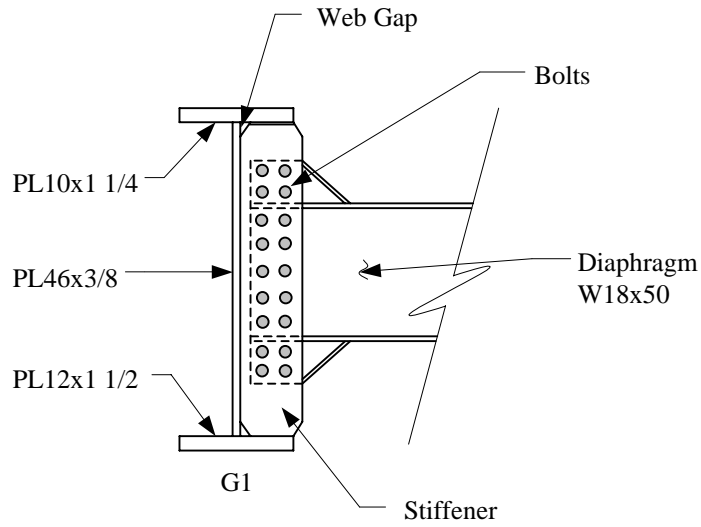

c. Diagram of a typical diaphragm/girder connection in the negative moment region of bridge 5075.5R080.

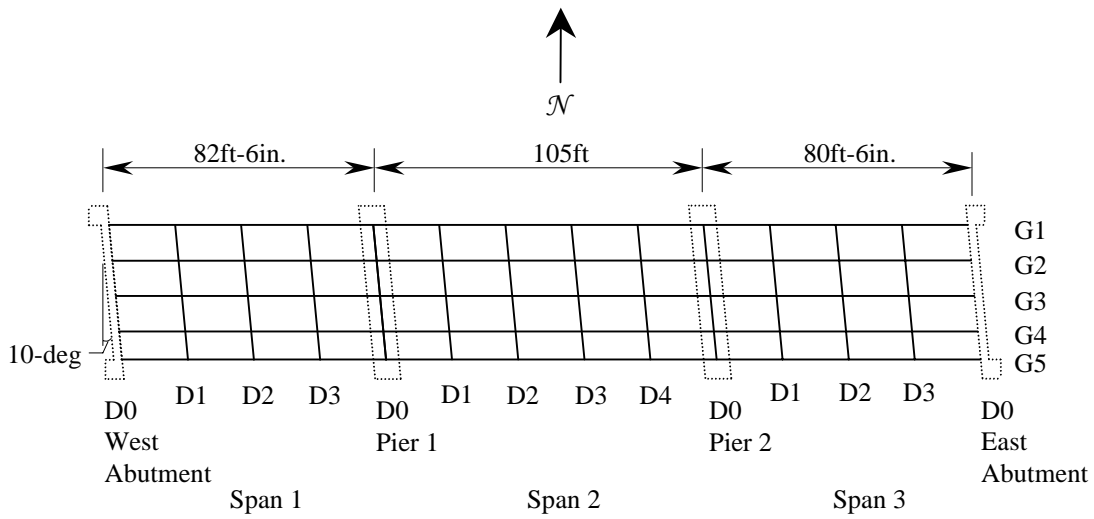

d. Plan view of bridge 5075.5R080 superstructure.

Figure 2: Bridge 5075.5R080 layout.



a. Bridge 2700.0R035 looking northeast.

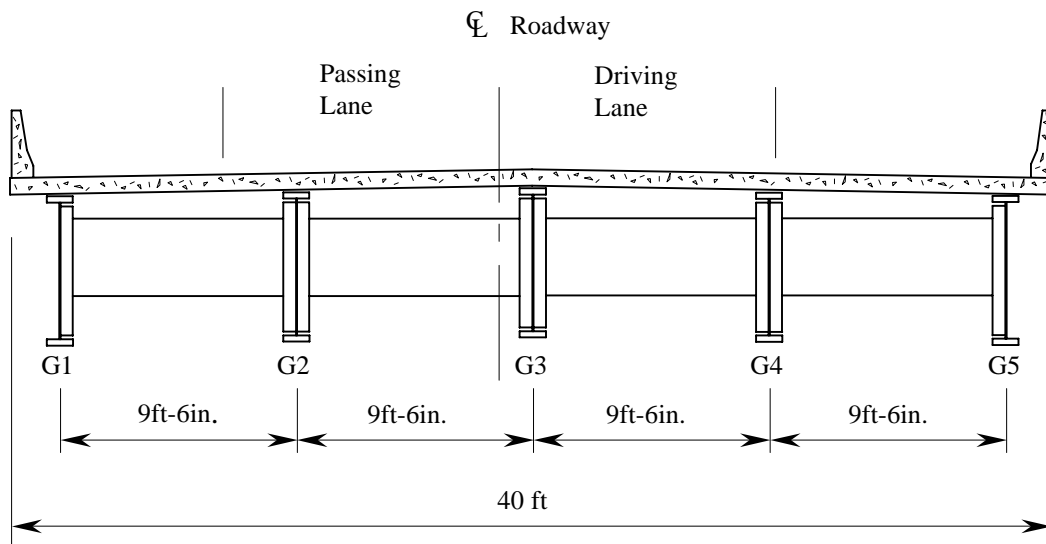

b. Cross section of bridge 2700.0R035 looking in direction of traffic.

Figure 3: Bridge 2700.0R035 layout (cont.).

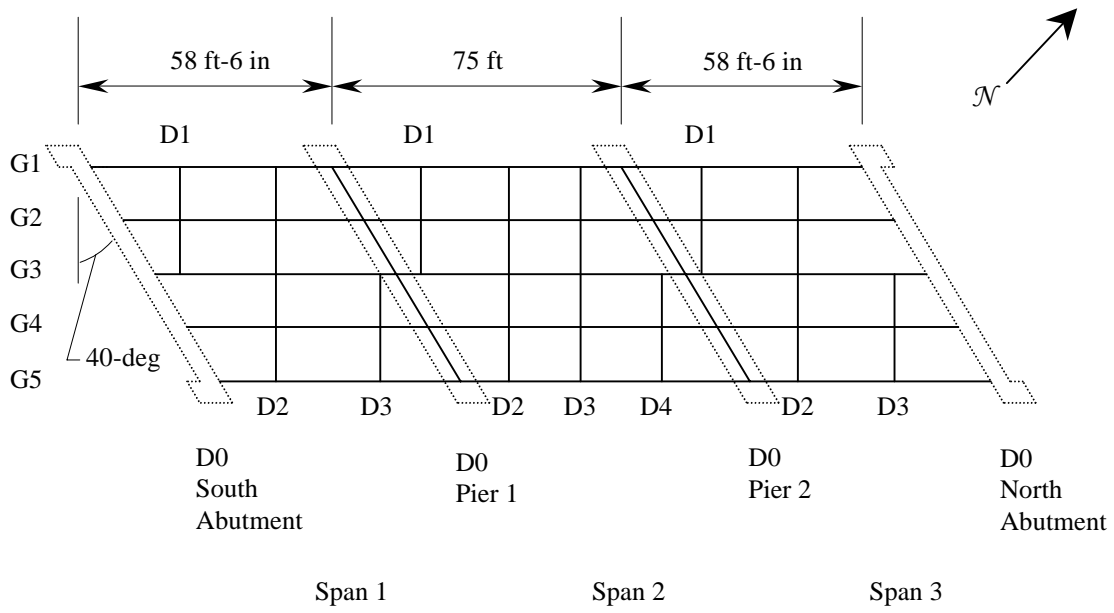

c. Plan view of bridge 2700.0R035 superstructure.

Figure 3: Bridge 2700.0R035 layout.



a. Bridge 4048.2S017 looking northeast

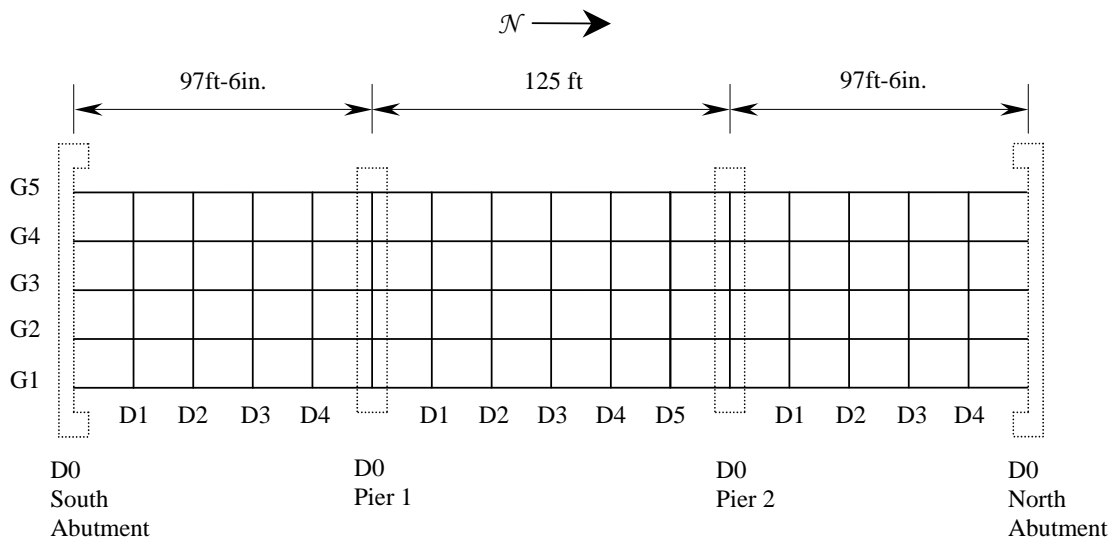

b. Plan view illustration of bridge 4048.2S017 superstructure.

Figure 4: Bridge 2700.0R035 layout (cont.).

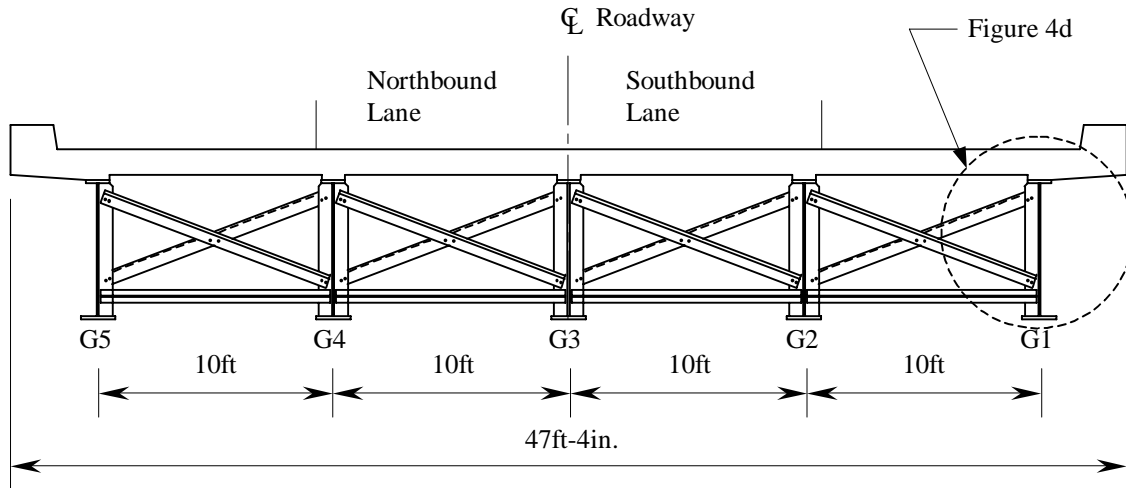

c. Cross section of bridge 4048.2S017.

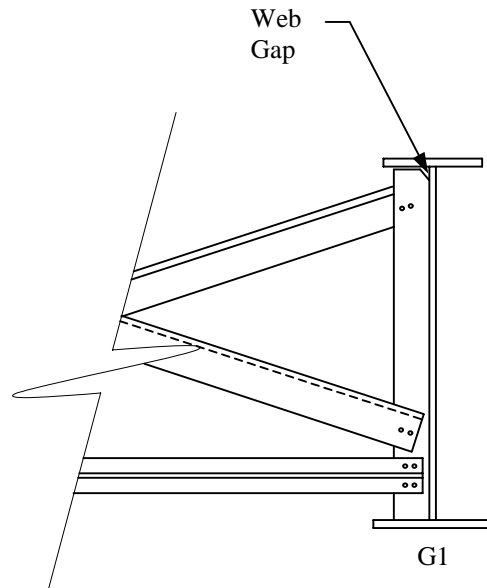

d. Diaphragm connection with web gap at stiffener clip on bridge 4048.2S017.

Figure 4: Bridge 4048.2S017 layout.

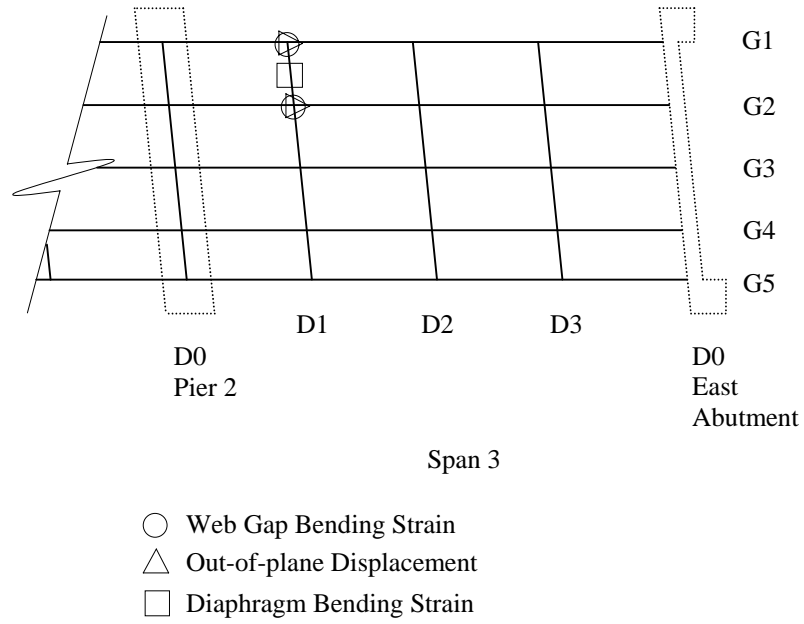
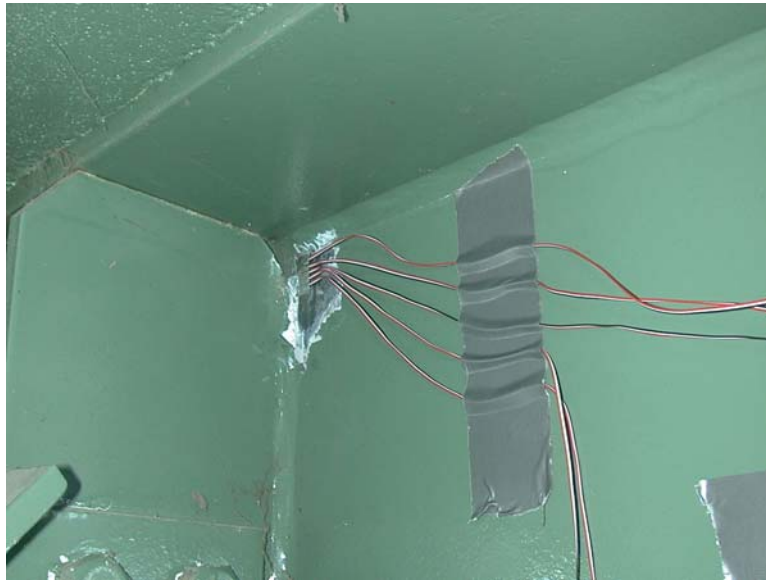

Figure 5: Typical plan view of gage placement (bridge 5075.5R080 shown).



a. Typical web gap gradient instrumentation (bridge 5075.5R080 shown).



b. Typical out-of-plane displacement instrumentation (bridge 5075.5R080 shown).

Figure 6: Typical instrumentation (cont.).

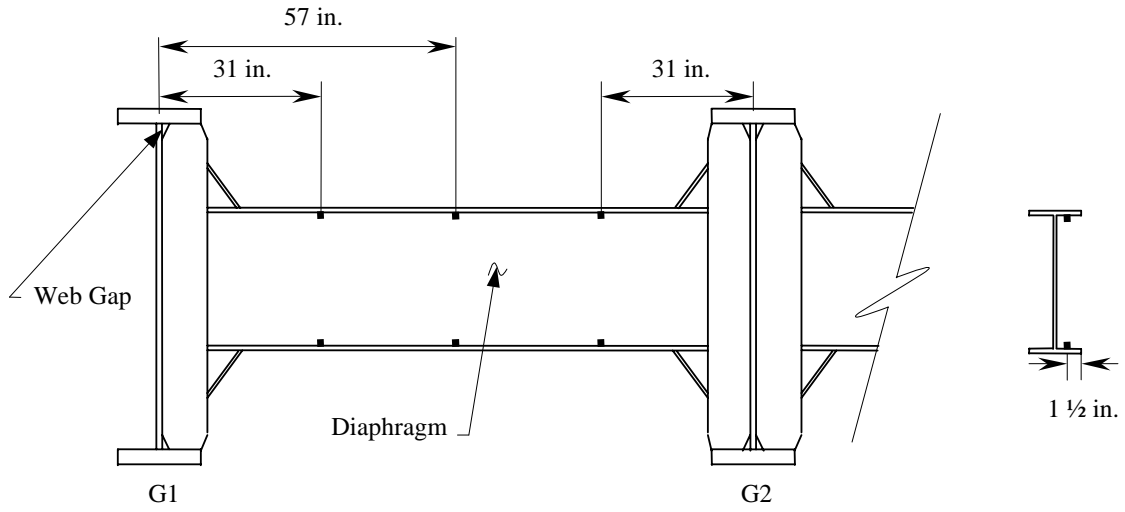

c. Typical diaphragm strain instrumentation looking east and south (bridge 5075.5R080 shown).

Figure 6: Typical instrumentation.

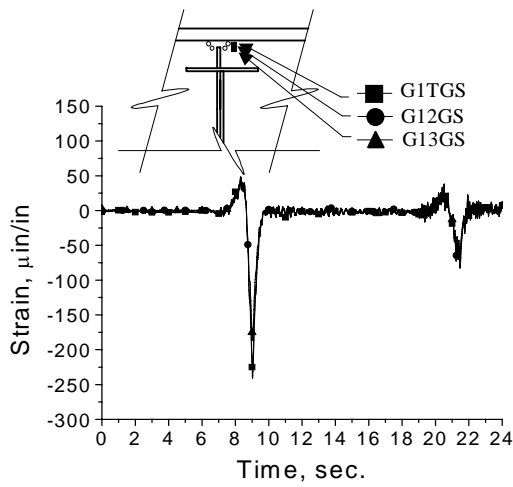

All bolts tight.

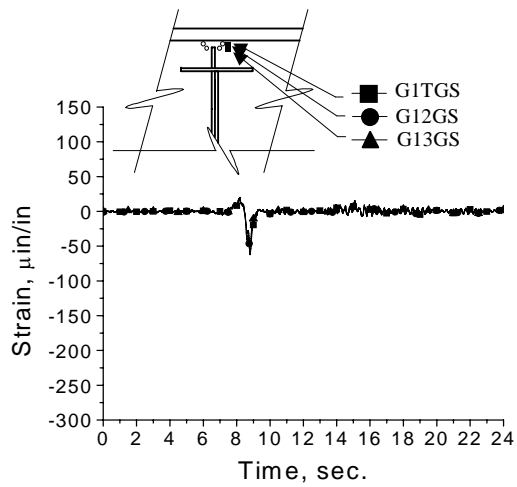

All bolts loose.

a. Exterior girder gradient strain plots (bridge 5075.5R080).

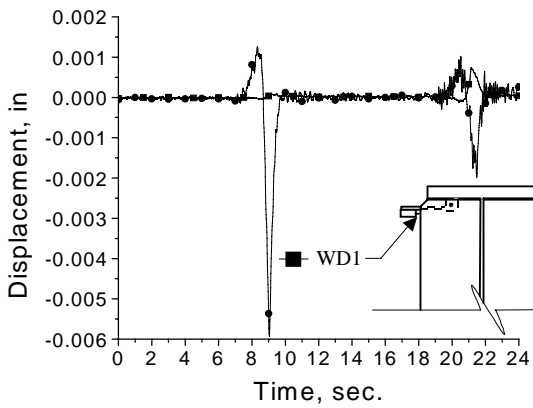

All bolts tight.

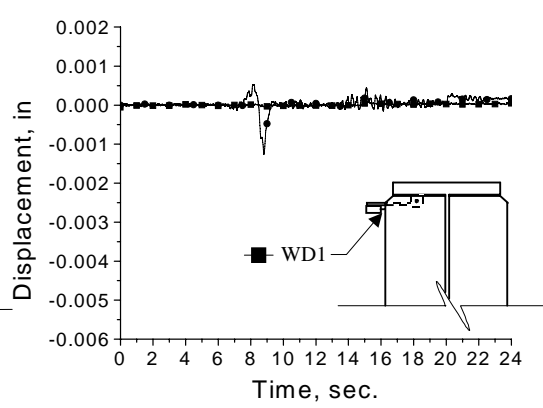

All bolts loose.

b. Out-of-plane displacement plots (bridge 5075.5R080).

Figure 7: Bridge 5075.5R080 test results (cont.).

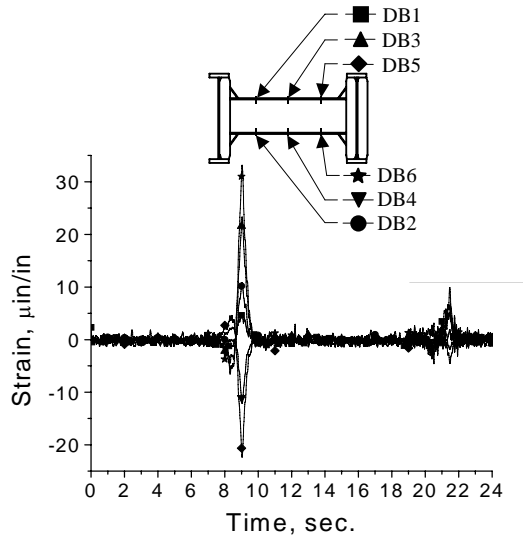

All bolts tight.

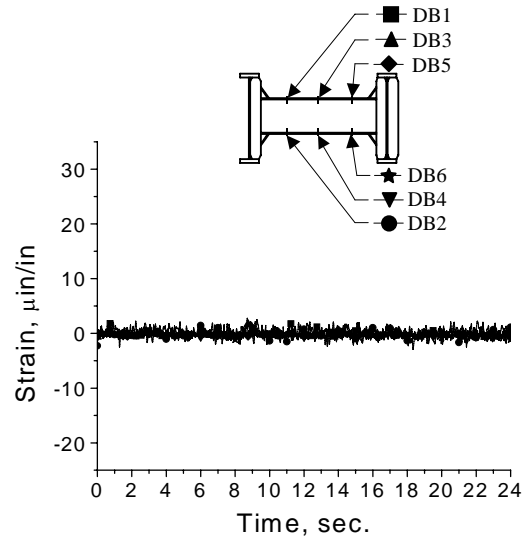

All bolts loose.

c. Diaphragm bending strain plots (bridge 5075.5R080).

Figure 7: Bridge 5075.5R080 test results.

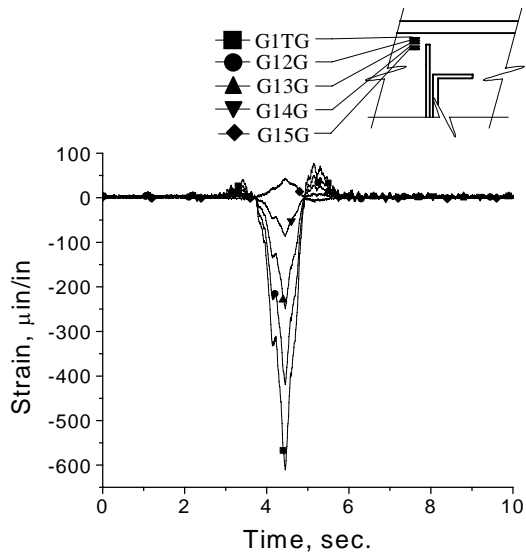

All bolts tight.

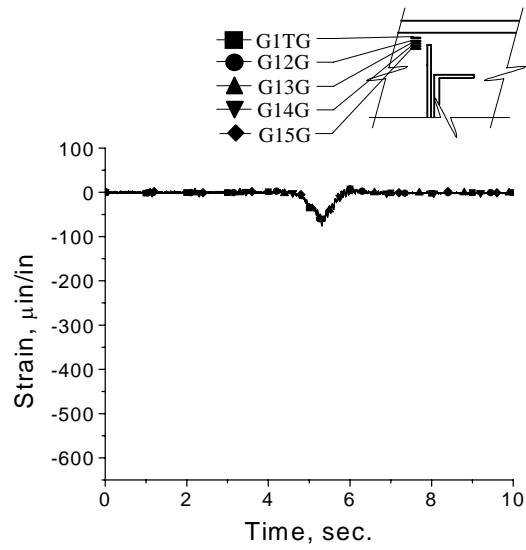

All bolts loose.

a. Exterior girder gradient strain plots (bridge 2700.0R035).

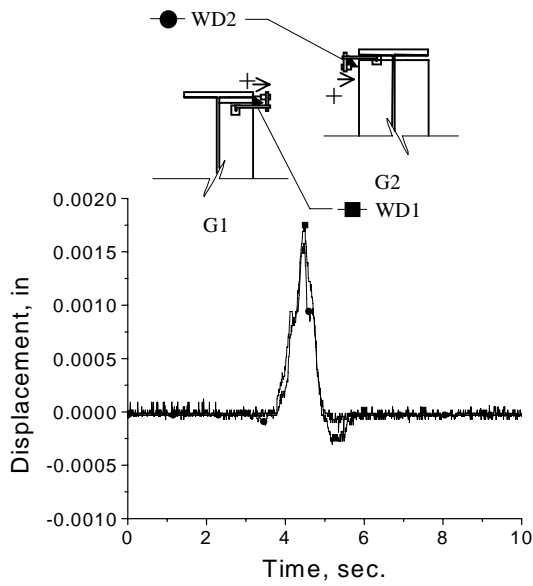

All bolts tight.

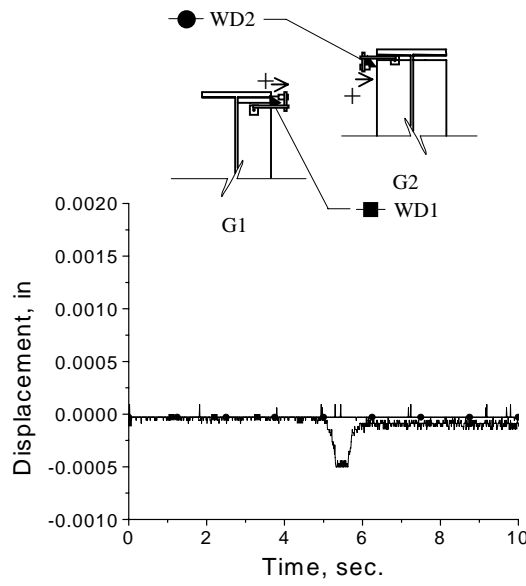

All bolts loose.

b. Out-of-plane displacement plots (bridge 2700.0R035).

Figure 8: Bridge 2700.0R035 test results (cont.).

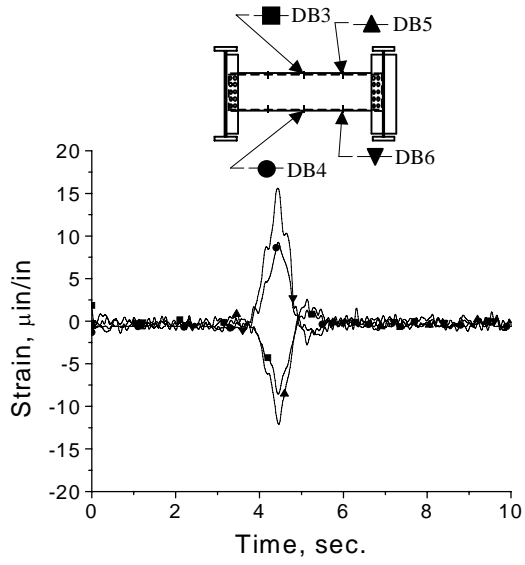

All bolts tight.

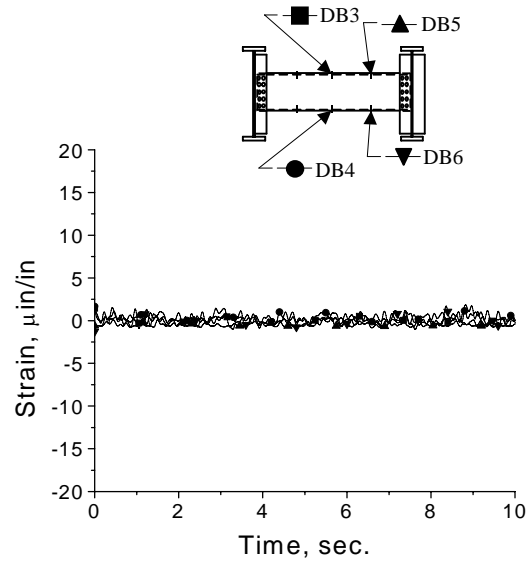

All bolts loose.

c. Diaphragm bending strain plots (bridge 2700.0R035).

Figure 8: Bridge 2700.0R035 test results.

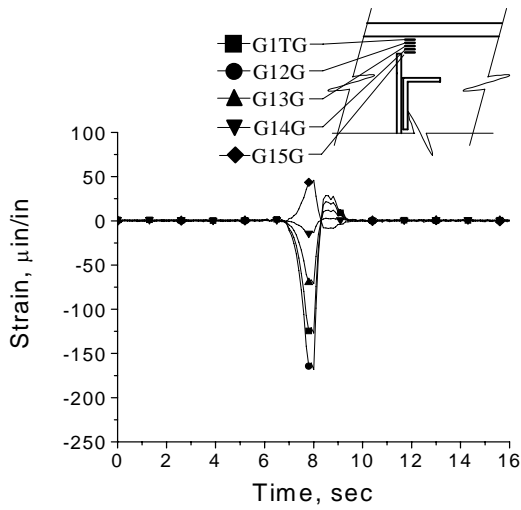

All bolts tight.

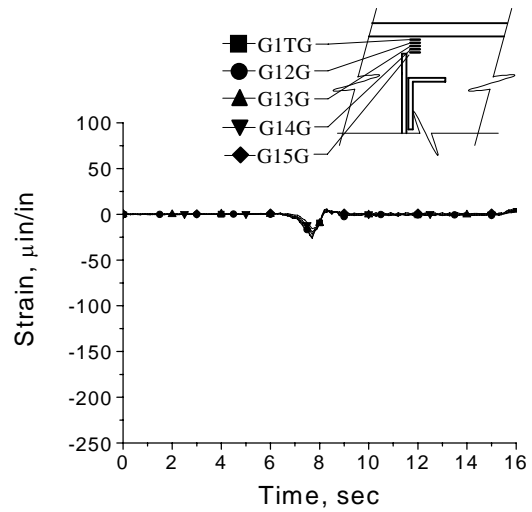

All bolts loose.

a. Exterior girder gradient strain plots (bridge 4048.2S017).

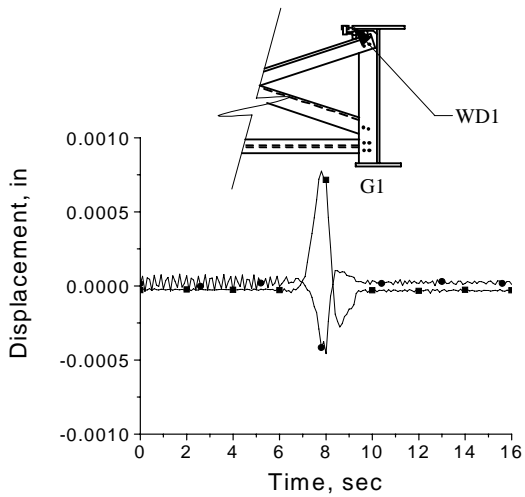

All bolts tight.

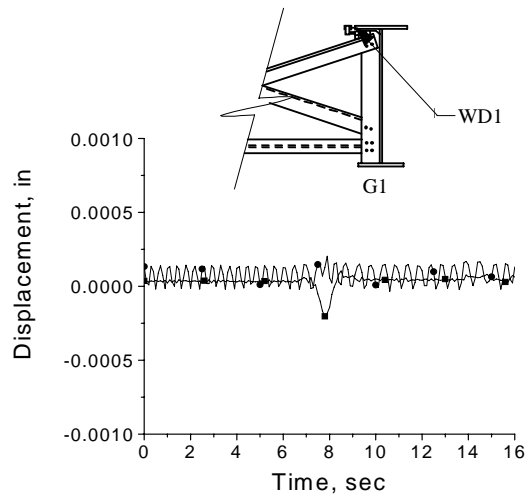

All bolts loose.

b. Out-of-plane displacement plots (bridge 4048.2S017).

Figure 9: Bridge 4048.2S017 test results (cont.).

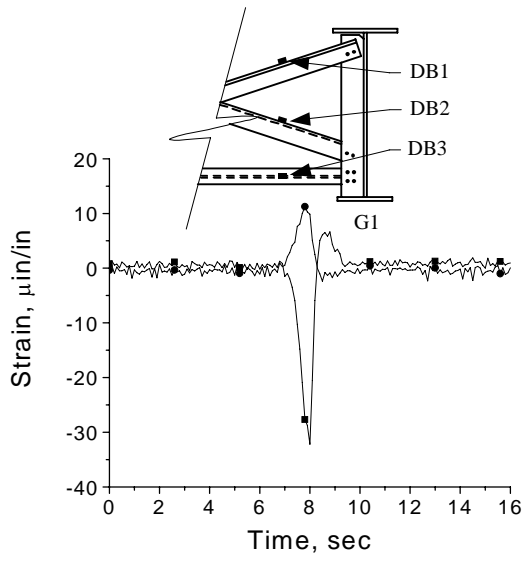

All bolts tight.

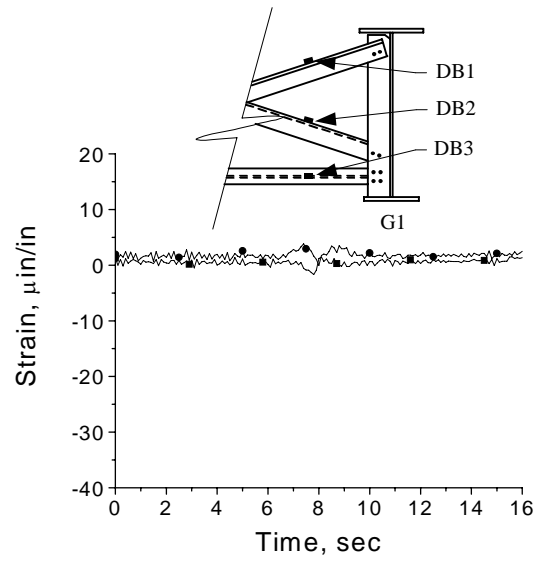

All bolts loose.

c. Diaphragm bending strain plots (bridge 4048.2S017).

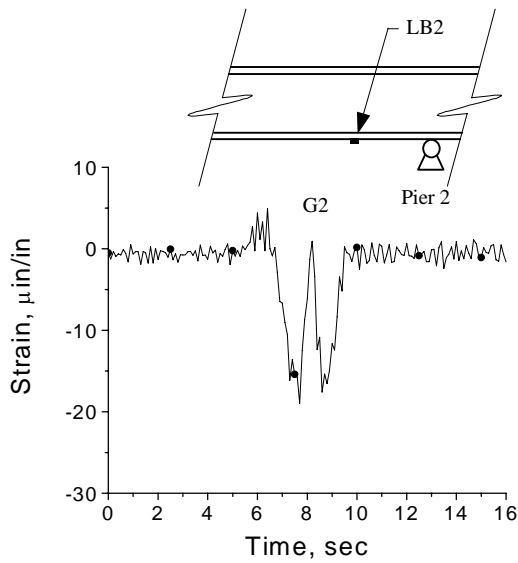

All bolts tight.

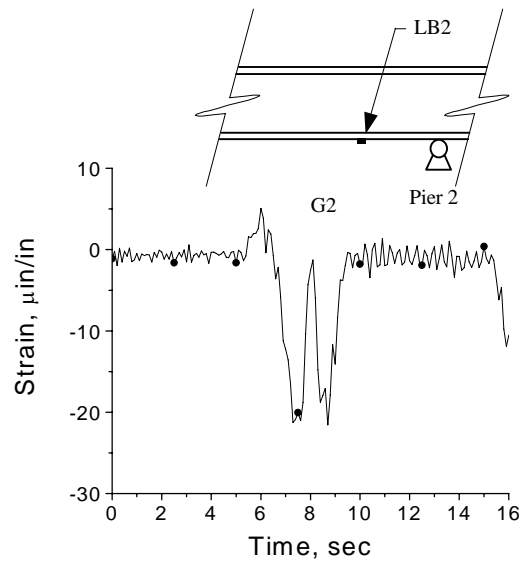

All bolts loose.

d. Longitudinal girder strain plots (bridge 4048.2S017).

Figure 9: Bridge 4048.2S017 test results.

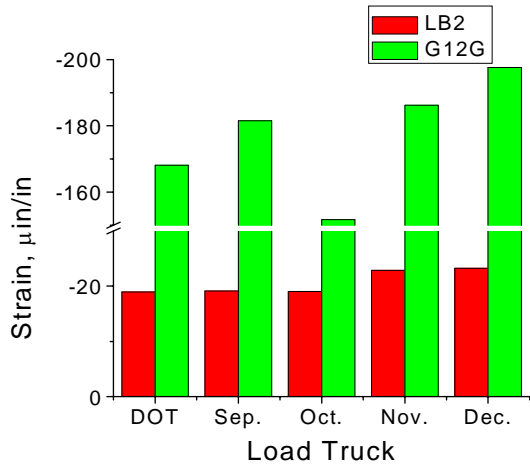

All bolts tight.

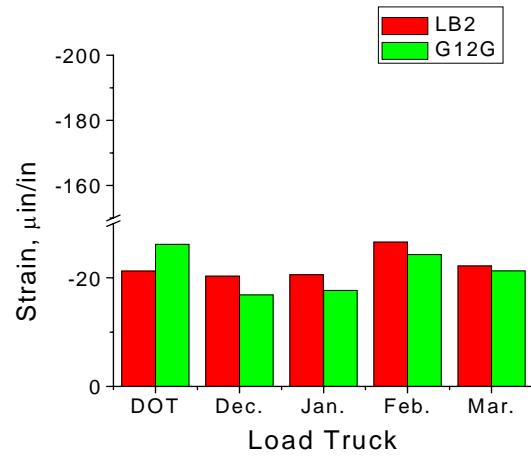

All bolts loose.

Figure 10: Maximum exterior web gap (G12G) strains and longitudinal girder strains for individual truck loadings on bridge 4048.2S017.