

# Iowa DOT Bridge Rail Guide



A guide to  
bridge rail  
hardware  
used in Iowa  
by Iowa DOT  
and Local  
Systems

Prepared by the Bridges  
and Structures Bureau  
Methods Unit

IOWA | DOT

# Iowa DOT Bridge Rail Guide

Table of Contents (p.1 of 2):

Preface	Guide Compilation Process and Resources
Index	Rail Listings for Each Section in this Guide
Section 1	Metal Tube and Channel Rails
Section 2	Vertical Face and Open Concrete Rails
Section 3	Safety Shape and Single Slope Concrete Rails
Section 4	Timber Rails

# Iowa DOT Bridge Rail Guide

Table of Contents (p.2 of 2):

Section 5	Thrie-Beam Rails (guardrail)
Section 6	W-Beam Rails (guardrail)
Section 7	Crash Cushions
Section 8	Unlisted Rails: Procedures for Documentation
Section 9	Barrier Rail Attachments
Section 10	Barrier End Sections
Section 11	Barrier Traffic Face Texture Guidelines

# Iowa DOT Bridge Rail Guide

## Preface: Guide Compilation Process and Resources (p. 1 of 2)

This guide attempts to document all bridge-mounted traffic rails used in Iowa. Various resources were researched for each of the bridge rails shown in order to determine whether rails were crash tested, had an assigned Performance Level (PL) or Test Level (TL), had an FHWA Eligibility Letter, AASHTO-ARTBA-AGC standard drawings, or any additional associated research beyond crash testing. Note that some supporting information is not in the guide, but is stored in the network folder identified on each rail page. Some rails in this guide were never crash tested and many of those rails do not have documentation in any of the resources listed. Various Iowa DOT databases were used to help find unique rail types for inclusion in this guide, but there are additional rails in service that are not yet covered here.

The following resources were used in compiling support information for each barrier shown in the Guide:

- FHWA Memorandum, "Crash Testing of Bridge Railings", May 30, 1997 and FHWA Letter HNG-10, May 07, 1996 with attachments and Appendices B5, B6 and B7c (collectively referred to as the "1997 FHWA Memo")
- Task Force 13 Hardware Guide (<https://tf13.org/guides/>), Bridge Railings and Longitudinal Barriers subpages
- University of Nebraska-Lincoln, Midwest Roadside Safety Facility (MwRSF) Research Hub (<https://mwrsf.unl.edu/researchhub.php>)
- Caltrans Bridge Rail Guide 2003, an FHWA-funded barrier documentation project (incl. 2005 updates)
- US Department of Transportation FHWA, Hardware Eligibility Letters (<https://highways.dot.gov/safety/rwd/reduce-crash-severity>)
- Texas A&M University, Texas Transportation Institute (TTI), roadside pooled fund (<https://www.roadsidepooledfund.org/mash-implementation/search/>)

# Iowa DOT Bridge Rail Guide

## Preface: Guide Compilation Process and Resources (p. 2 of 2)

Users of this guide shall be aware that no single resource listed on the preceding page is a complete and independent means by which the crashworthiness of a particular rail can be definitively established. Some resources contain errors and/or omissions related to rail types or their crash test levels, indicate Performance Level (PL) or Test Level (TL) numbers that cannot be corroborated with appropriate crash test documents such as research reports or FHWA Eligibility Letters, or list inaccurate AASHTO testing specifications. All errors and omissions in individual resources were cross-checked against information in the other available resources to arrive at the most defensible documentation of a bridge rail's crashworthiness. Published crash tests and FHWA-authored documents were typically used as the primary and most valid resources in any particular case. Where applicable, barrier names associated with the original crash test or FHWA listing have been retained for historical traceability.

In cases where a resource (e.g. a Task Force 13 rail summary) indicates a more recent AASHTO test specification than can be fully substantiated for a rail shown in this guide, the specification known to be referenced in the crash test report for that rail is shown on the rail page. These specifications directly impact the "B.RH.01" or "B.RH.02" code that is assigned to a rail under the provisions of the AASHTO Subsection 2.3, "Roadside Hardware" bridge rail coding requirement that is now part of bridge maintenance and inspection operations in all states.

The intent of this guide is to have additional pages added for rails previously undocumented by the guide so it can be as complete as possible for all future users (see Section 8 of this guide). This is especially important for creating the best reference for the bridge maintenance coding requirement under AASHTO's Subsection 2.3, "Roadside Hardware". Supporting information pertaining to any new rail should be stored in a new folder at the network location indicated on existing rail pages. Use a similar naming convention for new rail folders to maintain consistency and to uniquely describe any new rails.

Some rails used in Iowa by either Iowa DOT or by Local Systems (cities and counties) are unique or are represented on very few bridges in service. Whenever just a few examples were known to be in existence, the affected bridge locations were listed on the rail page as part of its documentation.

Initial publication Feb 2024 by Iowa DOT/BSB/Methods—**MOST RECENT UPDATE 07/15/2024**

# Iowa DOT Bridge Rail Guide

## Preface: AASHTO Specifications Comparison Tables

Bridge Railing Testing Criteria	Acceptance Equivalencies					
	TL1	TL2	TL3	TL4	TL5	TL6
MASH	TL1	TL2	TL3	TL4	TL5	TL6
Report 350	TL1	TL2	TL3	TL4	TL5	TL6
Report 230		MSL-1 MSL-2†				
1989 AASHTO Guide Spec		PL1		PL2	PL3	
AASHTO LRFD Bridge Spec		PL1		PL2	PL3	

† This is the performance level usually cited when describing a barrier tested under NCHRP Report 230. It is close to TL3 but adequate TL3 performance cannot be assured without a pickup truck test.

Test Level	Test Vehicle	NCHRP 350	MASH - 2009
TL-3	Small Car	Speed: 62 mph Angle: 20°	Speed: 62 mph Angle: 25°
TL-3	Pickup	Speed: 62 mph Angle: 25°	Speed: 62 mph Angle: 25°
TL-4	<u>S.U.T.</u>	Speed: 50 mph Angle: 15°	Speed: 56 mph Angle: 15°
TL-5	Tractor Trailer	Speed: 50 mph Angle: 15°	Speed: 50 mph Angle: 15°

Vehicle Class	NCHRP 350	MASH—2009
Small car 	820C Weight: 1,809 <u>lb</u>	1100C Weight: 2,420 <u>lb</u>
Pickup Truck 	2000P Weight: 4,409 <u>lb</u>	2270P Weight: 5,000 <u>lb</u> Min. <u>c.g.</u> height: 28 in.
Single Unit Truck 	8000S Weight: 17,636 <u>lb</u>	10000S Weight: 22,000 <u>lb</u>
Tractor Trailer 	36000V Weight: 79,366 <u>lb</u>	36000V Weight: 79,300 <u>lb</u>

# Iowa DOT Bridge Rail Guide

## Index (p.1 of 3)

### Section 1—Metal Tube and Channel Rails

- Aluminum Rectangular 2-Tube Rail on Curb
- Aluminum Rectangular 3-Tube Rail on Curb
- Aluminum Round 3-Tube Rail on Curb
- Aluminum Round 2-Tube Rail on Curb
- Aluminum Half-Ellipse 1-Tube Side-Mount
- Aluminum Safety Shape Rail
- Aluminum Picket Rail on Curb
- BR27C Flush-Mounted
- Modified B-25 Series
- Texas T80HT
- PennDOT PA
- MN Type 3 Combination Railing
- IL 2399 2-Rail on Curb
- IL 2399 Side-Mounted
- Washington DC Historic Retrofit
- Wyoming 2-Tube Curb-Mounted Railing
- Steel Round 2-Tube Rail on Curb

### Section 1—Metal Tube and Channel Rails (cont.)

- Steel Round 3-Tube Rail on Curb
- Steel Rectangular 2-Tube Rail on Curb
- Steel Channel 1-Rail on Curb
- Steel Channel 2-Rail on Curb (Type 1)
- Steel Channel 2-Rail on Curb (Type 2)
- Steel Channel 2-Rail (no curb; Type 1)
- Steel Channel 2-Rail (no curb; Type 2)
- Steel Angle Rail (Type 1)
- Steel Angle Rail (Type 2)
- Steel Angle Rail (Type 3)
- W-Beam on Steel Post
- Metal Pipe Railing—Light Construction

### Section 2—Vertical Face and Open Concrete Rails

- Iowa Concrete Block Retrofit
- Iowa Concrete Beam and Post (pre-2006)
- Iowa Concrete Beam and Post (2006+)
- Open Concrete Bridge Rail (OCBR) (MASH)

# Iowa DOT Bridge Rail Guide

## Index (p.2 of 3)

### Section 2—Vertical Face and Open Concrete Rails (cont.)

IBBR Separation Rail (MASH)

Vertical 27-in Separation Rail

32-in Vertical Concrete Parapet

42-in Vertical Concrete Parapet

Texas T411 Aesthetic Concrete Baluster

Texas F411

Aesthetic Precast Concrete Rail (US 30 Clinton)

Early 1900s Concrete Rails

### Section 3—Safety Shape and Single Slope Concrete Rails

New Jersey Safety Shape

TL-4 F-Shape Concrete

TL-5 F-Shape Concrete

Low-Profile 22-in Separation Rail

Single Slope Concrete 11 Degrees (Pre-MASH)

38-in Single Slope TL-4 Rail (MASH)

44-in Single Slope TL-5 Rail (MASH)

Single Slope with Setback Top

### Section 3—Safety Shape and Single Slope Concrete Rails (cont.)

Sloped Face Rails under 32 in

Short Sloped Parapet on Curb

### Section 4—Timber Rails

Timber Rail Types 1 thru 6

### Section 5—Thrie-Beam Rails (guardrail)

Thrie-Beam Types 1 thru 7

### Section 6—W-Beam Rails (guardrail)

W-Beam Types 1 thru 3

### Section 7—Crash Cushions

QuadGuard

QuadGuard Elite

QuadTrend

HEART

Smart Cushion

Hex-Foam Sandwich System

### Section 8—Unlisted Rails: Procedures for Documentation



# Iowa DOT Bridge Rail Guide

## Index (p.3 of 3)

### Section 9—Barrier Rail Attachments

Acrylite Soundstop TL-4 Noise Barrier

MnDOT TL-4 Back-Mounted Bicycle Railing

Safety Shape with Combo Rail

Top-Mounted Bicycle Railing

Back-Mounted Bicycle Railing

Barrier-Mounted Fence Type 1

Barrier-Mounted Fence Type 2

### Section 10—Barrier End Sections

F-Shape Barrier End for Guardrail

Single Slope Barrier End for Guardrail

Vertical-Face Barrier End for Guardrail

Steel-on-Concrete Barrier Ends

Concrete Barrier Sloped End Transitions (p.1 of 2)

Concrete Barrier Sloped End Transitions (p.2 of 2)

Steel-on-Concrete Barrier Sloped End Transitions

### Section 11—Barrier Traffic Face Texture Guidelines

Concrete Form Liner Texture

Concrete Rustication

Integral Thin Veneer Brick

# Section 1: Metal Tube and Channel Rails

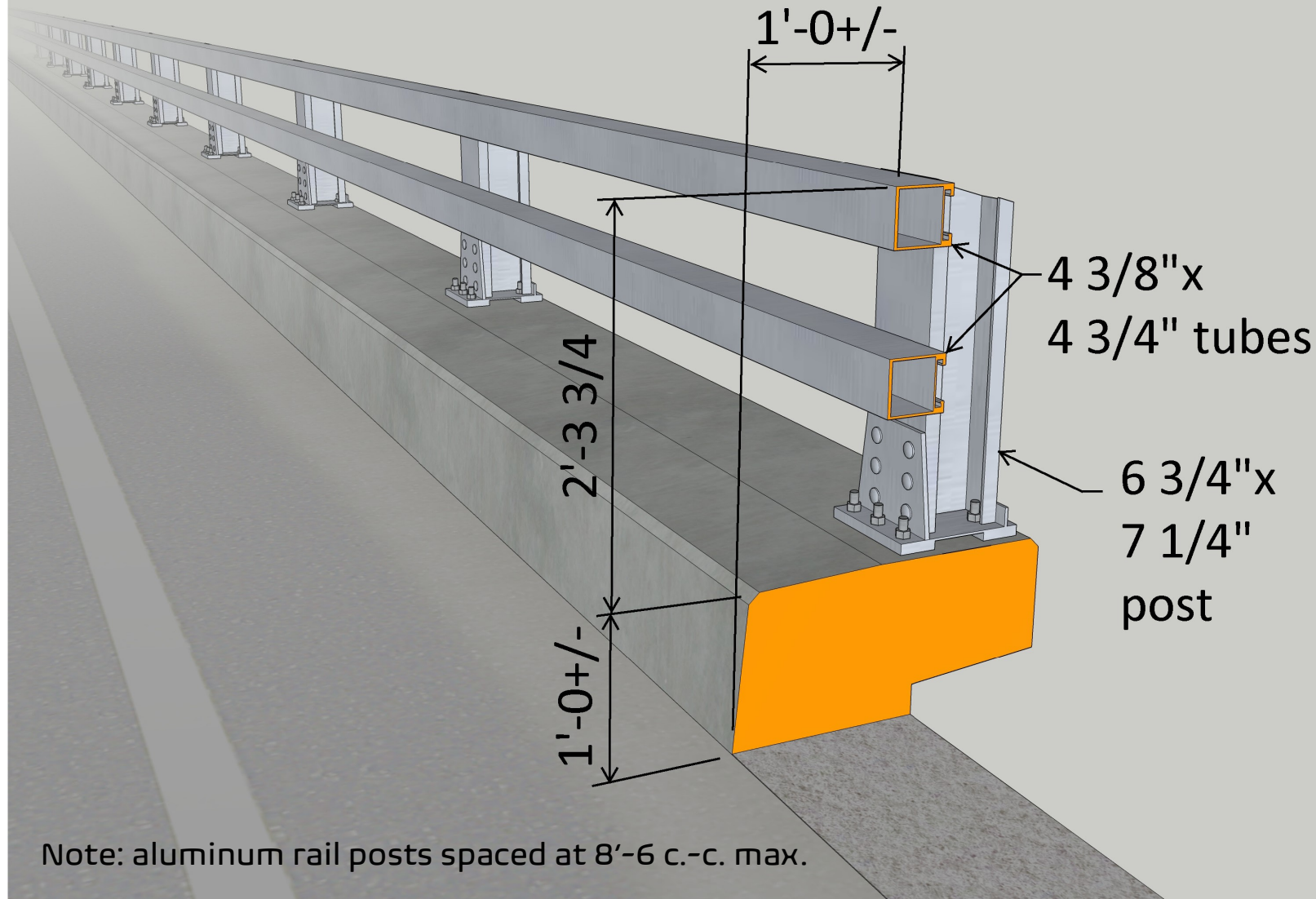

## Aluminum Rectangular 2-Tube Rail on Curb

- Test Spec: unknown; unsuccessfully crash tested to NCHRP 230 in 1988
- Rail is geometrically compliant with AASHTO Specifications for Highway Bridges 2.7.1 Vehicular Railings; may be fully compliant with a successful structural check against Section 2.7.1.3; note that height of curb is irrelevant since metal railing height is compliant
- Current MASH equivalency: unknown
- AASHTO B.RH.01 Code: S65
- Notes: also known as the "Iowa Box-Aluminum Bridge Rail"; currently (as of 2023) in service on ~75 bridges with design numbers dating from 1965 to 1980
- Crash test report: TRP-03-13-88 (failed)
- W:\Highway\Bridge\MethodsSection\Barriers\Rail Guide\2\_Other Pre-MASH Rails Used by DOT\Alum Rect 2-Tube Rail on Curb

# Section 1: Metal Tube and Channel Rails

## Acceptable Variations:

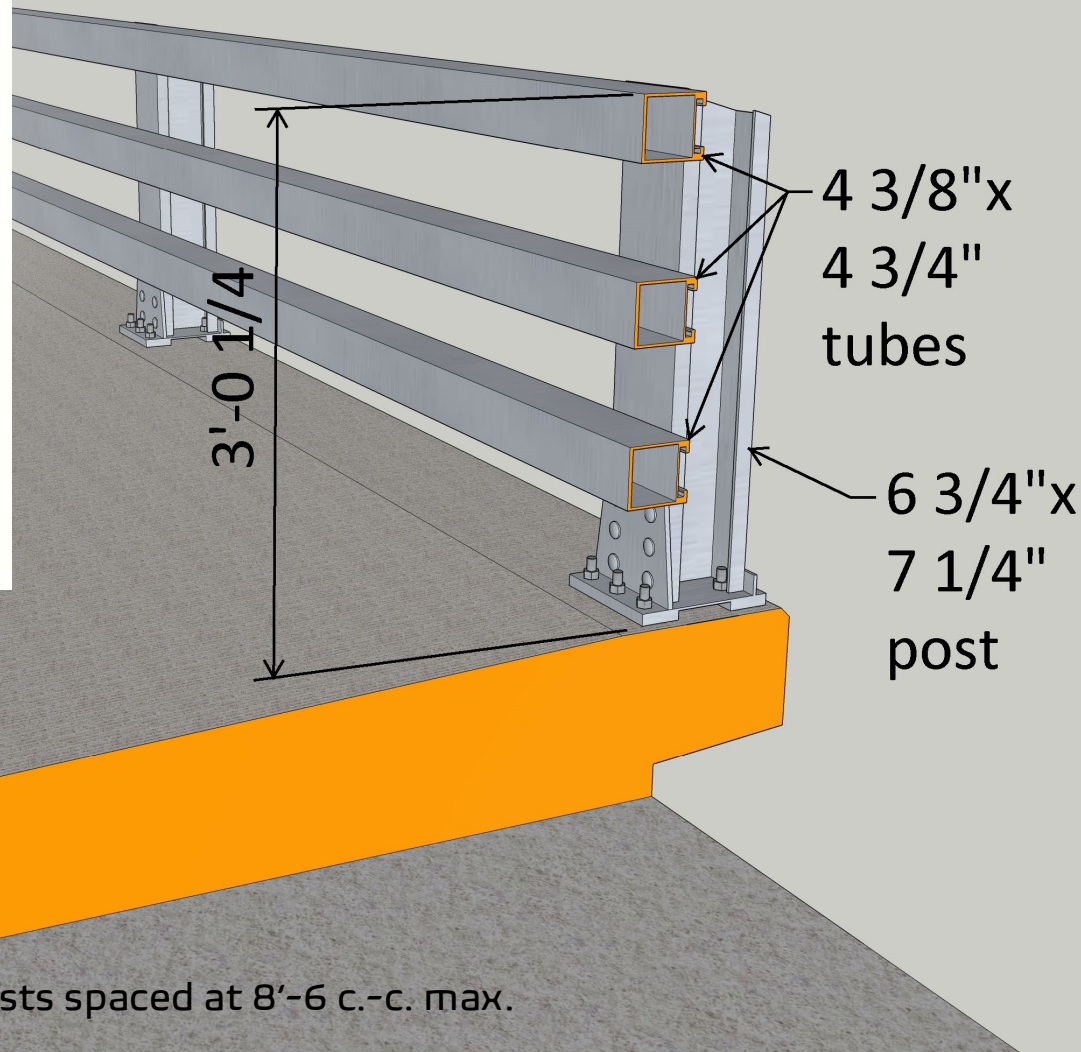
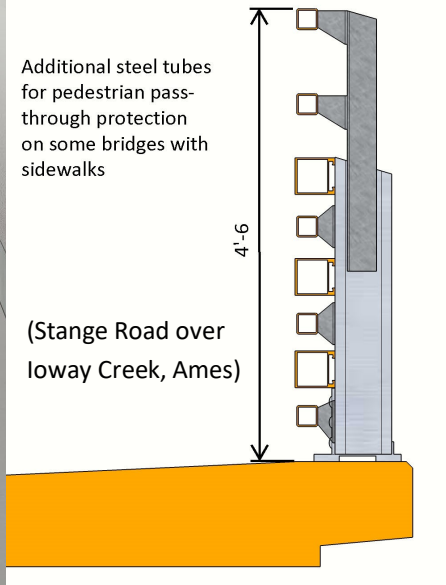

Note: aluminum rail posts spaced at 8'-6 c.-c. max.

## Aluminum Rectangular 3-Tube Rail on Curb

- Test Spec: unknown; similar 2-tube rail was unsuccessfully crash tested to NCHRP 230 in 1988
- Rail is geometrically compliant with AASHTO Specifications for Highway Bridges 2.7.1 Vehicular Railings; may be fully compliant with a successful structural check against Section 2.7.1.3; note that height of curb is irrelevant since metal railing height is compliant
- Current MASH equivalency: unknown
- AASHTO B.RH.01 Code: S65
- Note: currently (as of 2023) in service on at least 5 bridges with design numbers dating from 1965 to 1977
- Crash test report: TRP-03-13-88 (failed)
- W:\Highway\Bridge\MethodsSection\Barriers\Rail Guide\2\_Other Pre-MASH Rails Used by DOT\Alum Rect 3-Tube Rail

# Section 1: Metal Tube and Channel Rails

## Acceptable Variations:

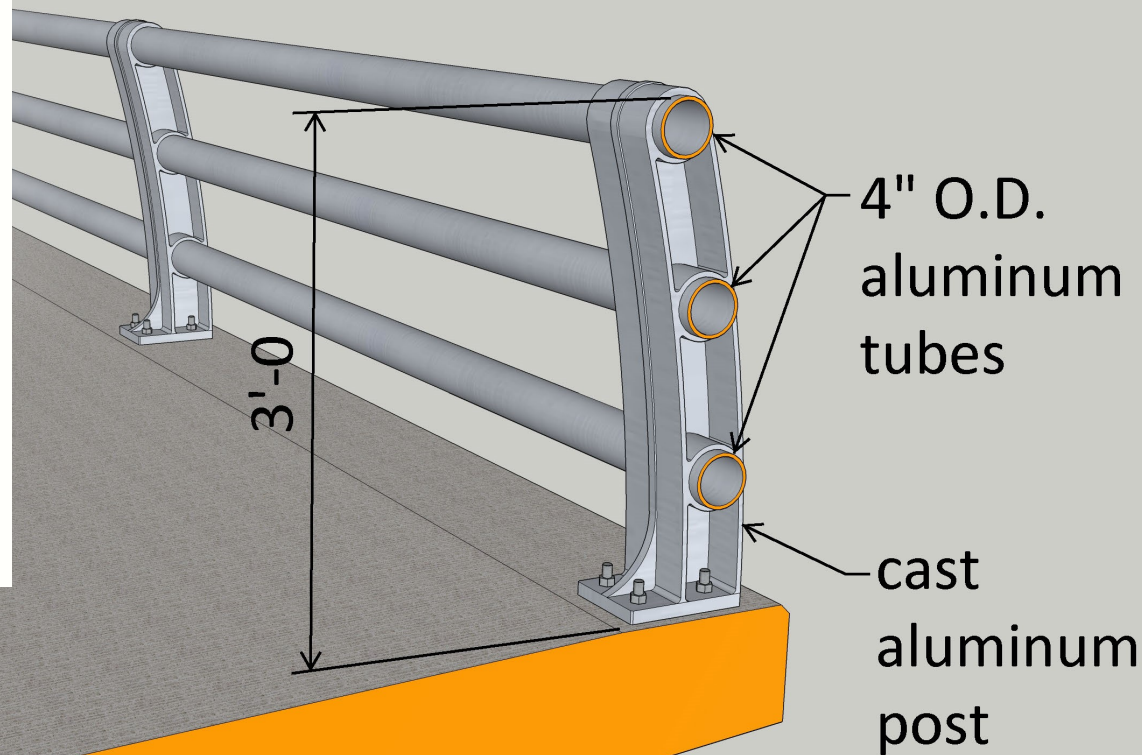
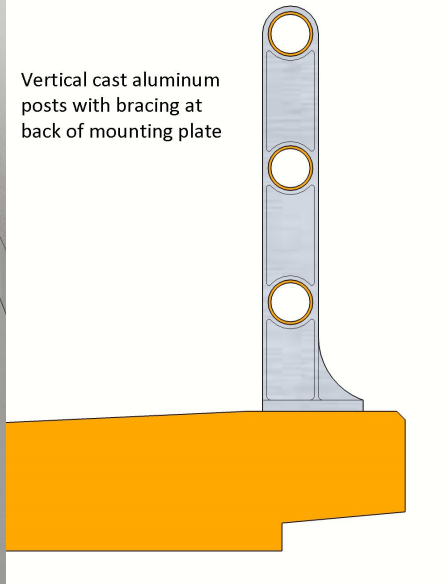

## Aluminum Round 3-Tube Rail on Curb

- Test Spec: unknown/not tested
- Rail is geometrically compliant with AASHTO Specifications for Highway Bridges 2.7.1 Vehicular Railings; may be fully compliant with a successful structural check against Section 2.7.1.3; note that height of curb is irrelevant since metal railing height is compliant
- Current MASH equivalency: unknown
- AASHTO B.RH.01 Code: S58
- W:\Highway\Bridge\MethodsSection\Barrier s\Rail Guide\2\_Other Pre-MASH Rails Used by DOT\Alum Round 3-Tube Rail

Note: aluminum rail posts spaced at 9'-6 c.-c. max.

# Section 1: Metal Tube and Channel Rails

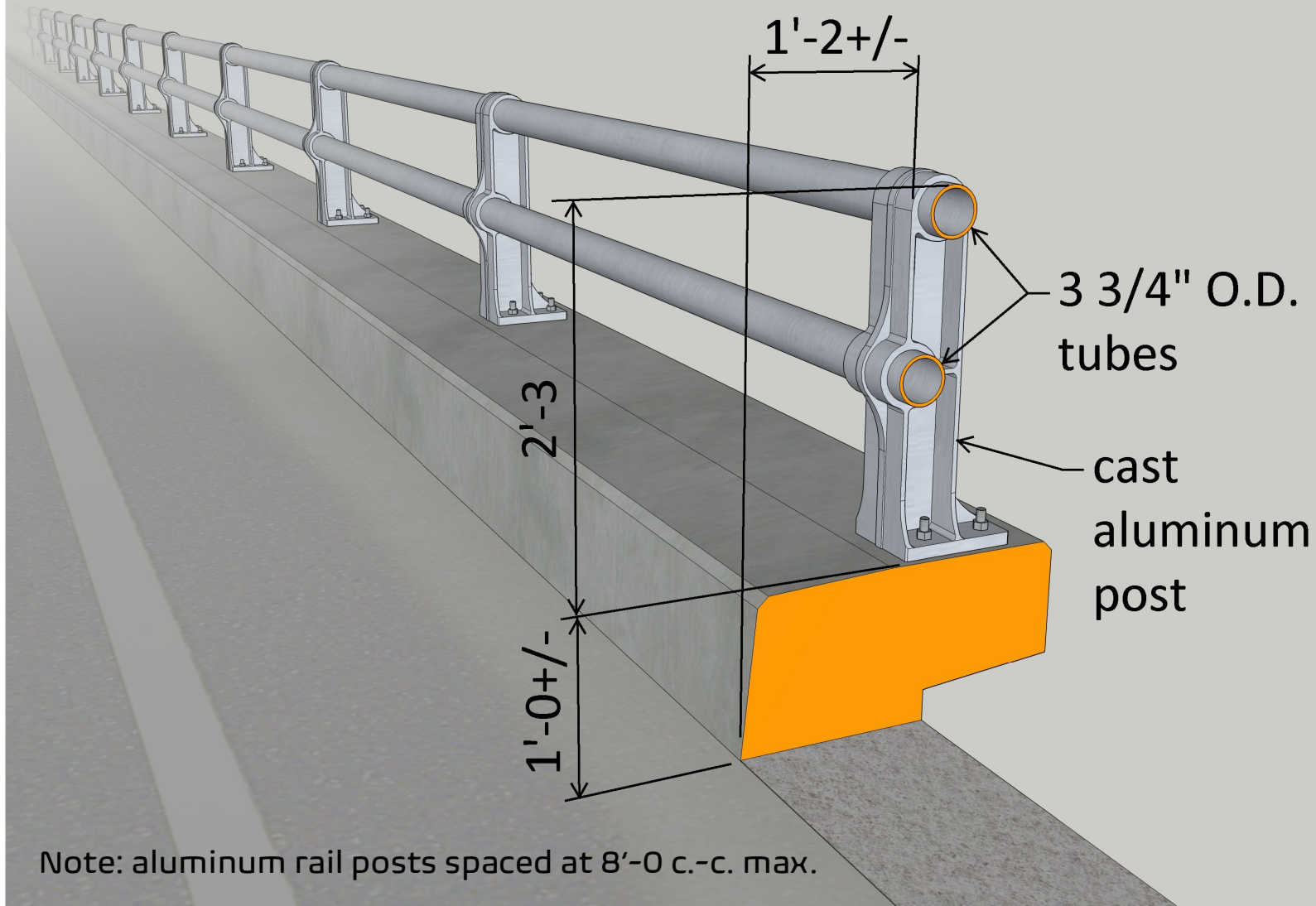

Note: aluminum rail posts spaced at 8'-0 c.-c. max.

## Aluminum Round 2-Tube Rail on Curb

- Test Spec: unknown/not tested
- Rail is not compliant with AASHTO Specifications for Highway Bridges 2.7.1 Vehicular Railings (1" max. vertical misalignment between rails on traffic face)
- Current MASH equivalency: unknown
- AASHTO B.RH.01 Code: S58
- Note: currently (as of 2023) in service on 10 bridges with design numbers dating from 1958 to 1965
- W:\Highway\Bridge\MethodsSection\Barriers\Rail Guide\2\_Other Pre-MASH Rails Used by DOT\Alum Round 2-Tube Rail on Curb

# Section 1: Metal Tube and Channel Rails

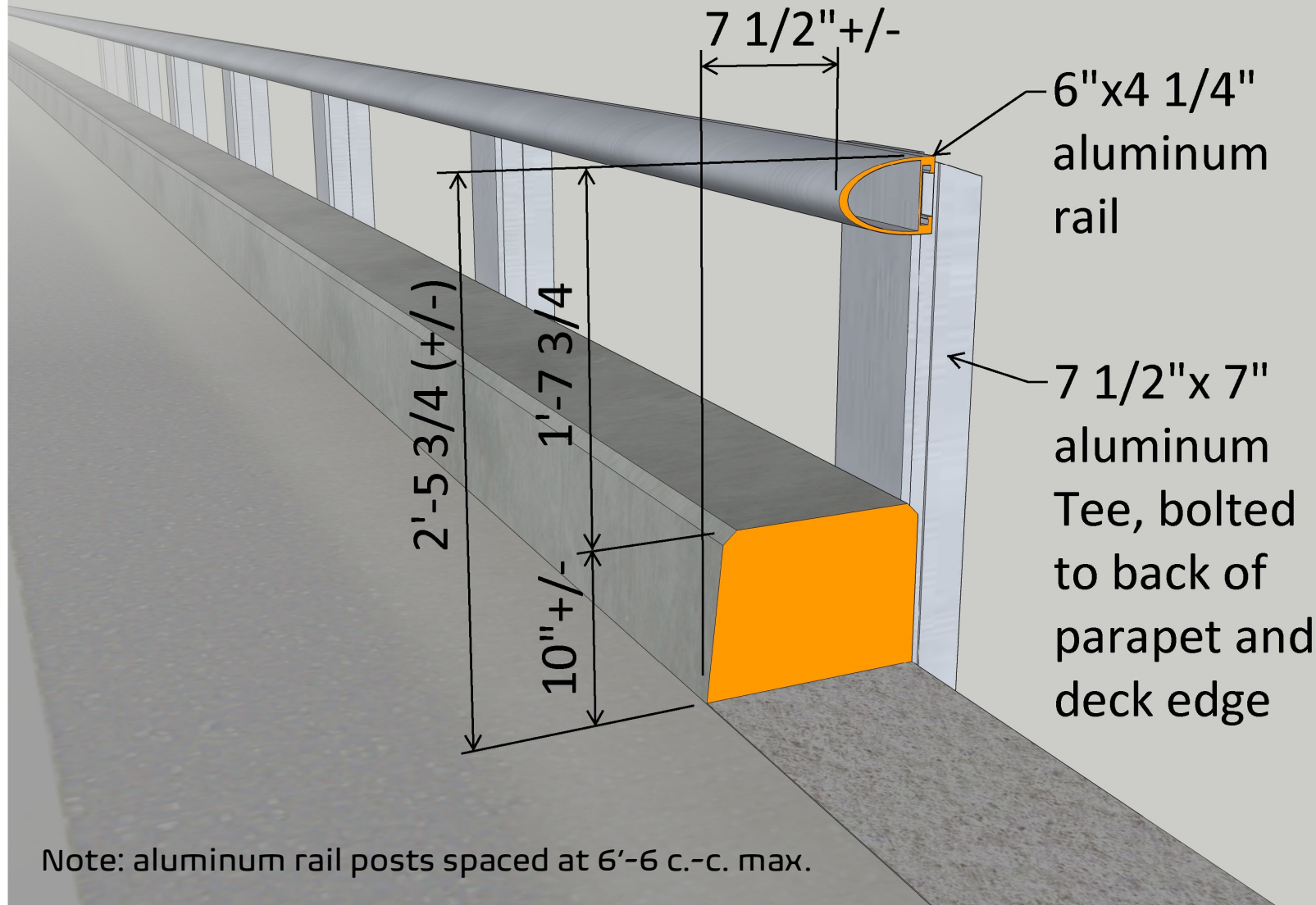

## Aluminum Half Ellipse 1-Tube Side-Mount

- Test Spec: unknown/not tested
- Rail geometry is not compliant with AASHTO Specifications for Highway Bridges 2.7.1 Vehicular Railings (inadequate parapet height, excessive space between parapet and top rail, vertical misalignment in excess of 1")
- Current MASH equivalency: unknown
- AASHTO B.RH.01 Code: S57
- Note: this rail was part of Standards J5-1, J5-2, and J6-1, dated as early as 1957; currently (as of 2023) in service on 6 bridges (incl. 3 within State Parks) with design numbers dating from 1972 to 1982.
- W:\Highway\Bridge\MethodsSection\Barriers\Rail Guide\2\_Other Pre-MASH Rails Used by DOT\Alum Half Ellipse 1-Tube Side-Mount

# Section 1: Metal Tube and Channel Rails

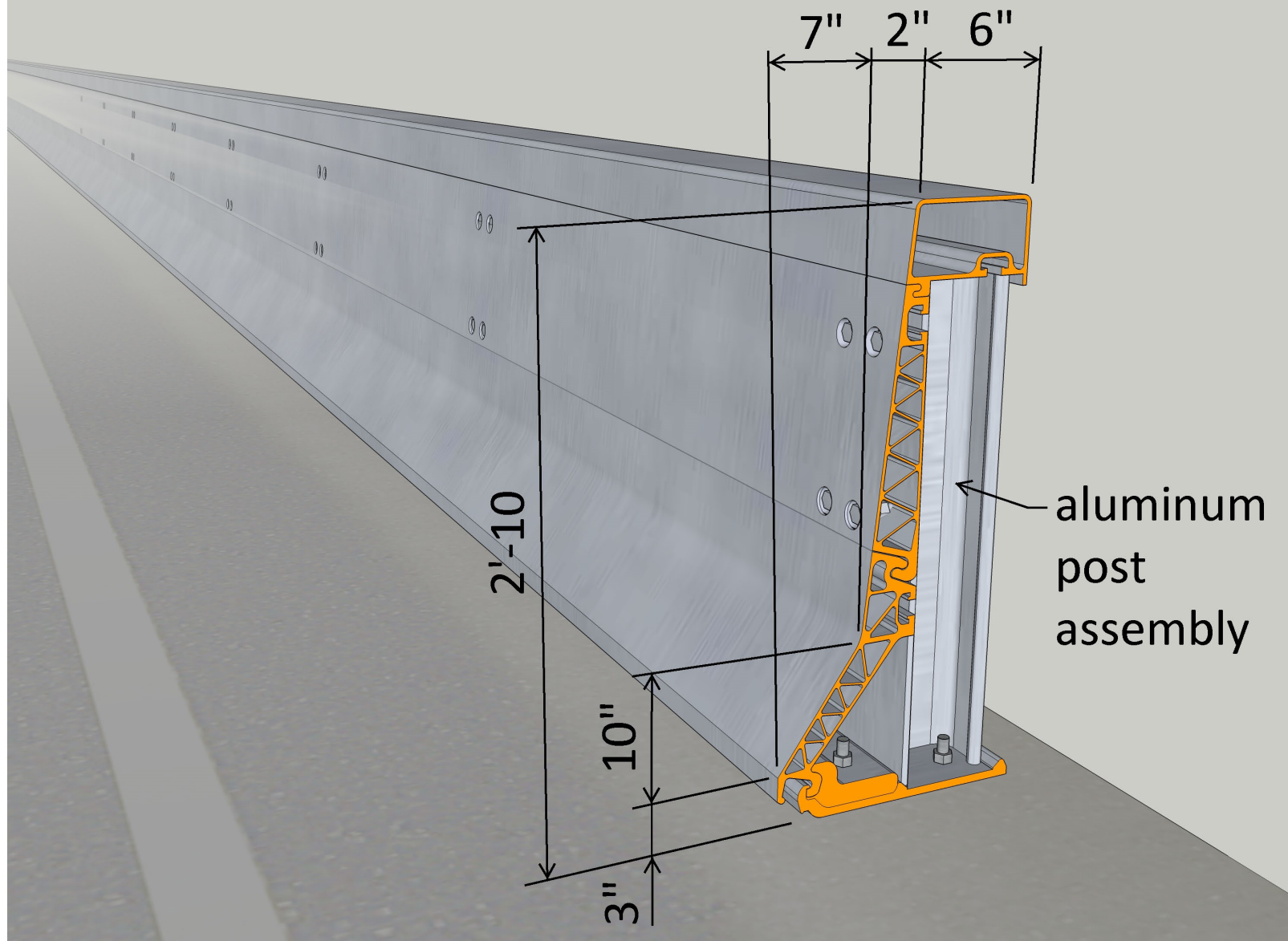

## Aluminum Safety Shape Rail

- NCHRP 350, TL-4
- Current MASH equivalency: TL-3 based on stability/height and geometry; strength may require verification
- AASHTO B.RH.01 Code: 3504
- Notes: measured height must be 2'-10 min. at all points on bridge; the rail shown is a proprietary system developed by a single manufacturer; currently (as of 2023) in service on one bridge; due to its proprietary nature, future use requires specific MASH Committee review and approval
- Example location: US 30 over the Mississippi River at Clinton, Iowa; border bridge administered by Illinois; rail updated in 1998 to the configuration shown
- W:\Highway\Bridge\MethodsSection\Barriers\Rail Guide\2\_Other Pre-MASH Rails Used by DOT\Aluminum Safety Shape Rail

# Section 1: Metal Tube and Channel Rails

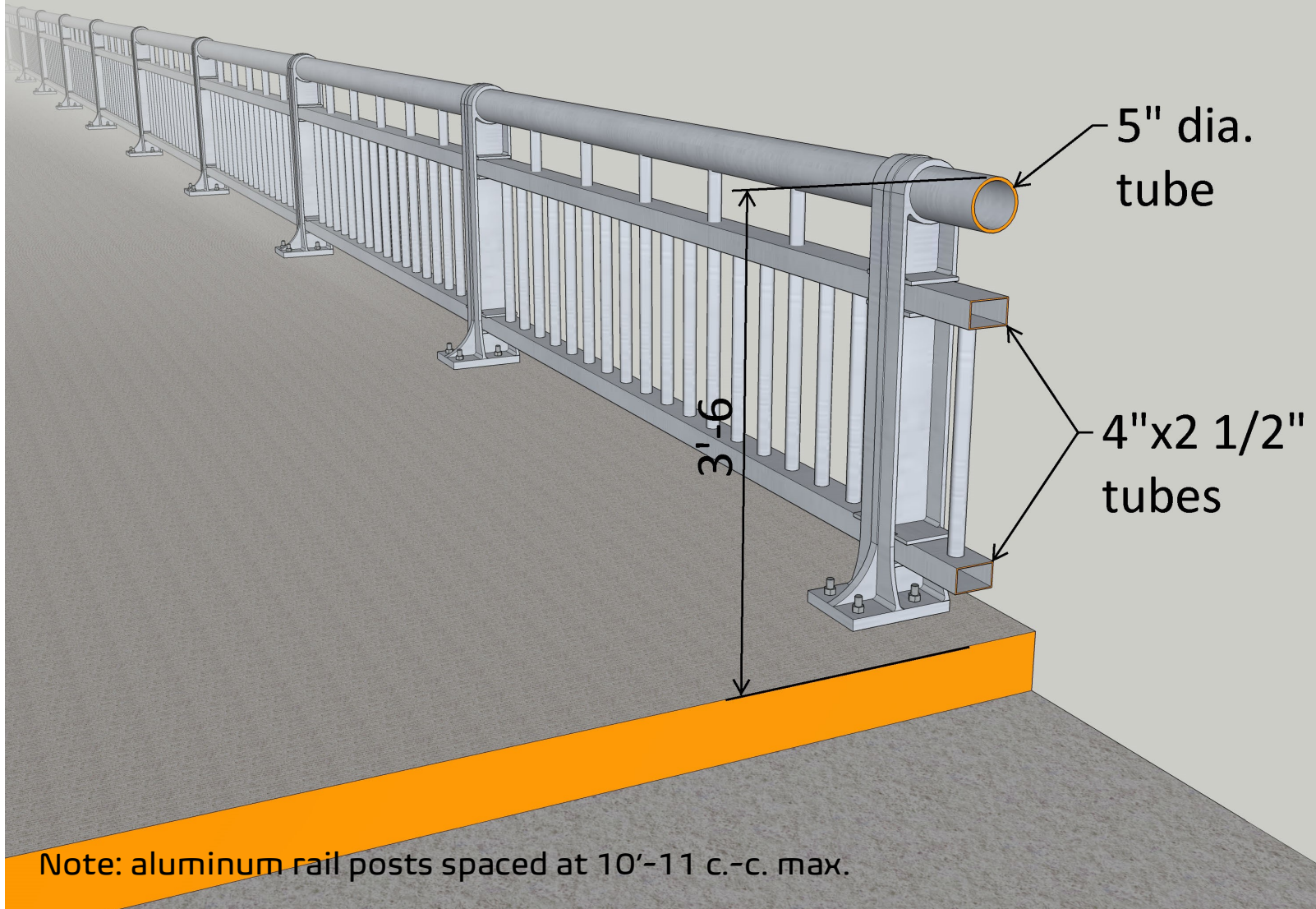

Note: aluminum rail posts spaced at 10'-11 c.-c. max.

## Aluminum Picket Rail on Curb

- Test Spec: unknown/not tested
- Rail geometry is not compliant with AASHTO Specifications for Highway Bridges 2.7.1 Vehicular Railings (excessive space between horizontal rails); strength unknown
- Current MASH equivalency: unknown
- AASHTO B.RH.01 Code: I
- Notes: designed for an urban low speed condition along the outside edge of sidewalk only; currently (as of 2023) in service on 1 bridge built in 1963
- Example location: US 151 Bus/1st Avenue over the Cedar River, Cedar Rapids, Linn Co.
- W:\Highway\Bridge\MethodsSection\Barriers\Rail Guide\2\_Other Pre-MASH Rails Used by DOT\Aluminum Picket Rail in CR



# Section 1: Metal Tube and Channel Rails

## Acceptable Variations:

Additional top tube on sidewalk side when used as a separation barrier

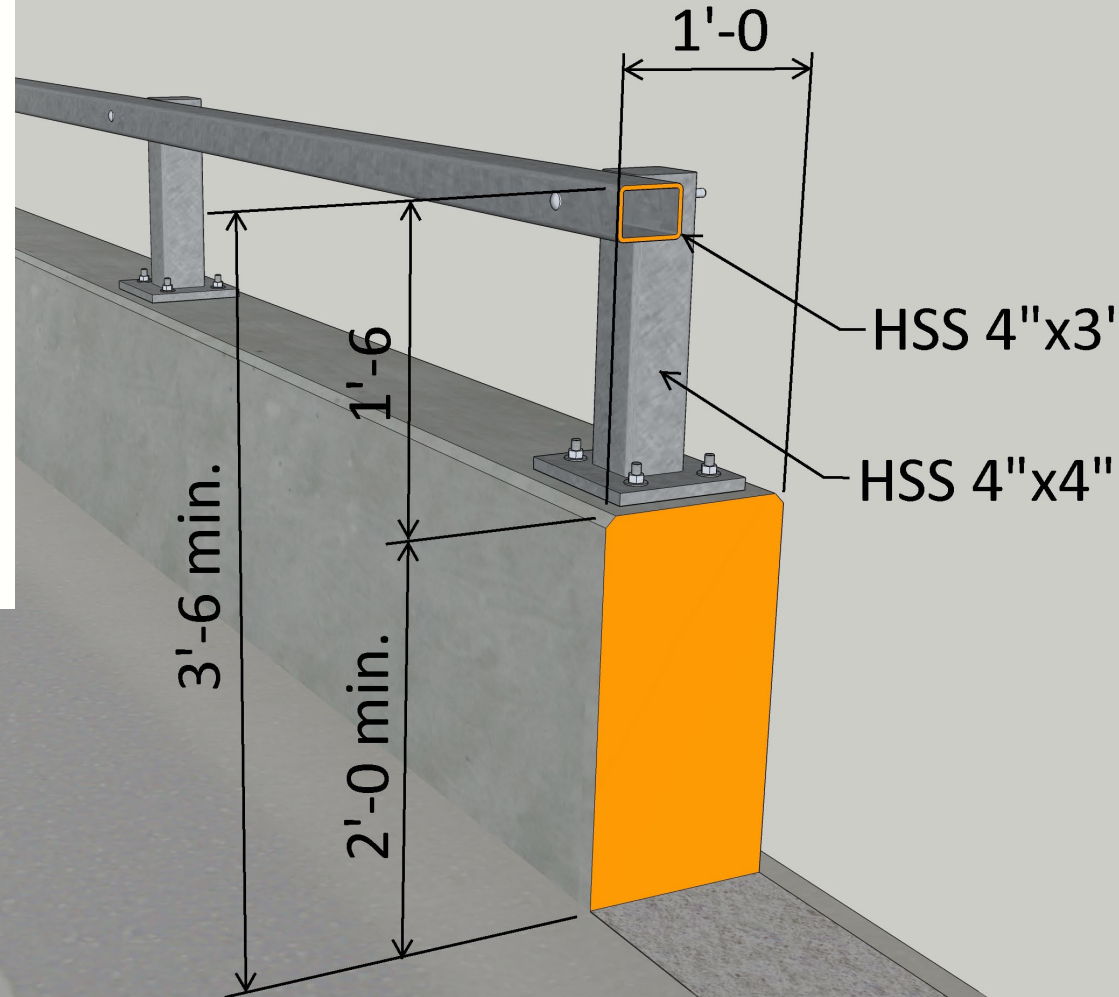
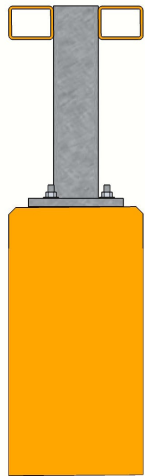

Note: steel rail posts spaced at 6'-6 c.-c. max.

## BR27C Flush-Mounted

- AASHTO Guide Specifications for Bridge Railings, PL-2 (equivalent to NCHRP 350 TL-4; see 1997 FHWA Memo)
- Current MASH equivalency: TL-4 based on 42" min. height and geometry (parapet 24" min.), but strength may require verification; see NCHRP Report 20-07(395)
- AASHTO B.RH.01 Code: 892
- Note: measured height must be 3'-6 min. at all points on bridge
- Crash test reports: FHWA-RD-93-058, TRP-03-325-15, MDOT\_Research\_Report\_R-1397\_315240\_7
- Example locations: US 20 over Iowa River, IA 100 over Cedar River, IA 98 over Des Moines River, US 61 SB over Flint Creek
- W:\Highway\Bridge\MethodsSection\Barriers\Rail Guide\1\_1997 FHWA Memo Rails+NCHRP 350\BR27C Flush-Mount

# Section 1: Metal Tube and Channel Rails

## Acceptable Variations:

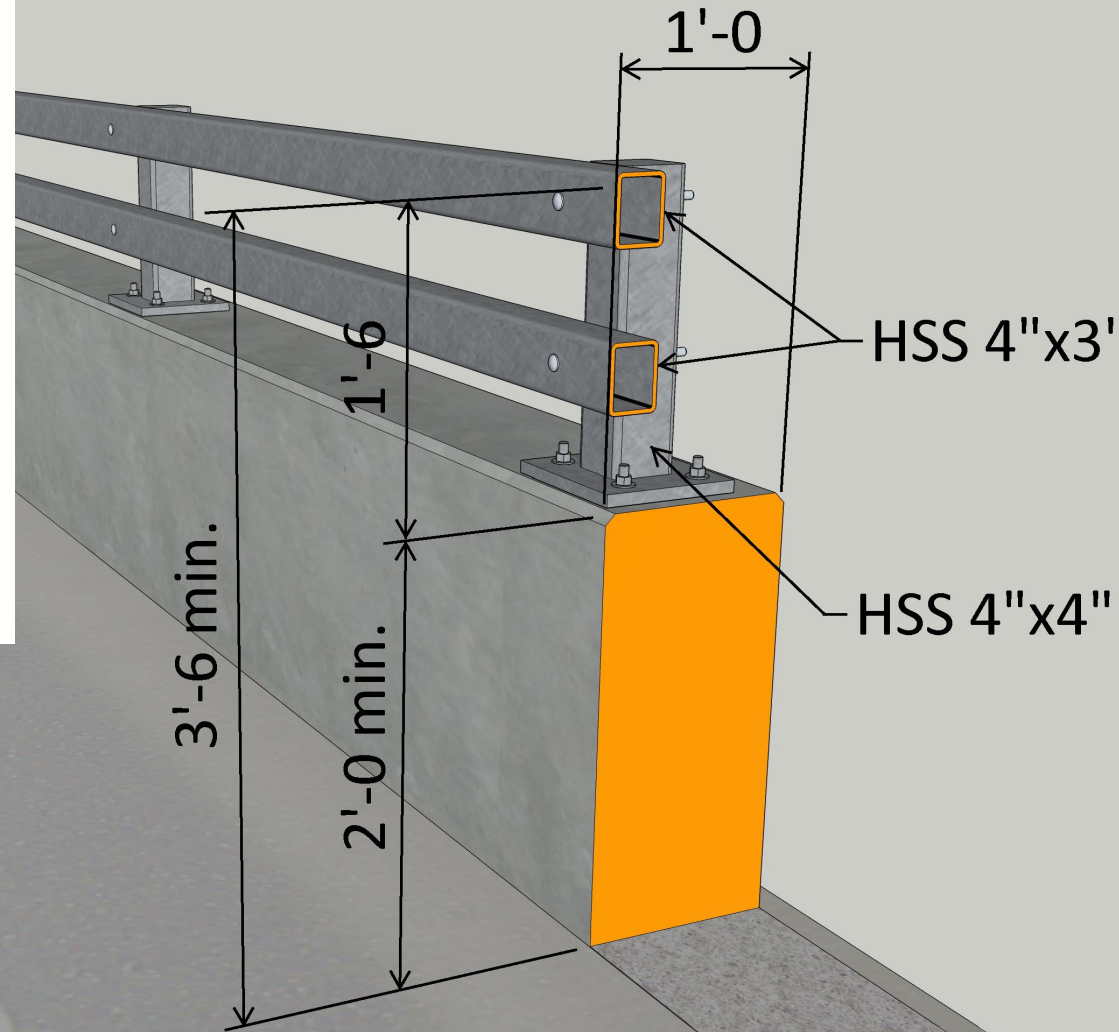

Note: steel rail posts spaced at 6'-6 c.-c. max.

## Modified B-25 Series

- AASHTO Guide Specifications for Bridge Railings, PL-2 (equivalent to NCHRP 350 TL-4)
- Current MASH equivalency: TL-4 based on 42" min. height and geometry (parapet 24" min.), but strength may require verification; see NCHRP Report 20-07(395)
- AASHTO B.RH.01 Code: 892
- Note: measured height must be 3'-6 min. at all points on bridge
- Crash test reports: FHWA-RD-93-058, FHWA-RD-93-065, TRP-03-325-15, MDOT Research\_Report\_R-1397\_315240\_7
- Example locations: US 61 NB over Flint Creek (Des Moines County Design 217), IA 28 over Raccoon River (Polk County Design 125)
- W:\Highway\Bridge\MethodsSection\Barriers\Rail Guide\3\_MASH Era Rails\_ also see MASH\Modified B-25 Series

# Section 1: Metal Tube and Channel Rails

## Acceptable Variations:

Additional tube on sidewalk side when used as a separator

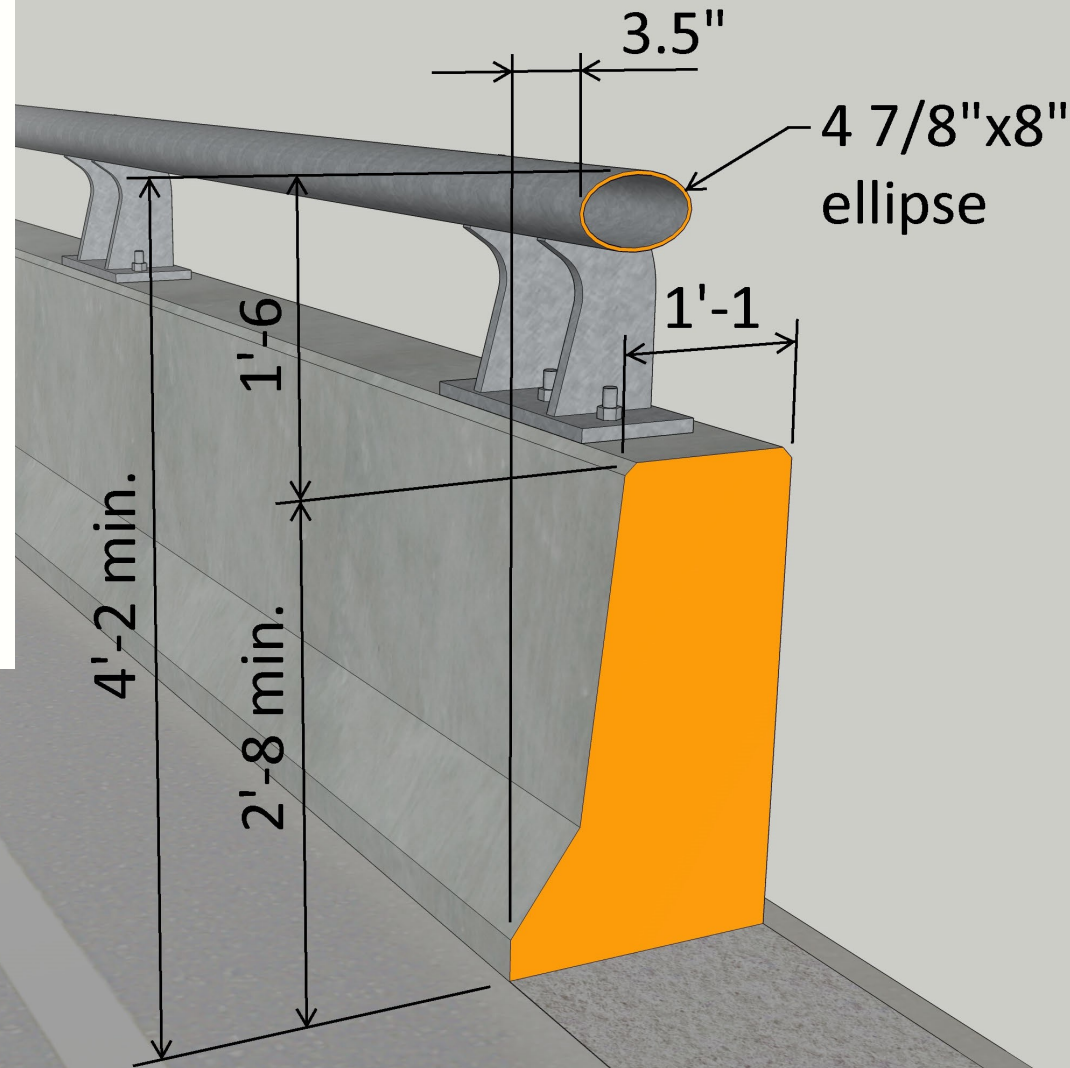
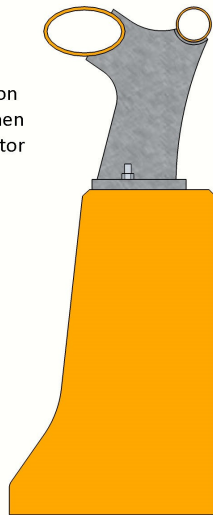

Note: steel rail posts spaced at 8'-0 c.-c. max.

## Texas T80HT

- NCHRP Report 230, PL-3 (equivalent to NCHRP 350 TL-5; see 1997 FHWA Memo)
- Current MASH Equivalency: TL-5 based on height and geometry, but strength may require verification; similar rail tested for MD to MASH TL-4 in 2019
- AASHTO B.RH.01 Code: 2303
- Note: measured height must be 4'-2 min. at all points on bridge
- Also known as "PA HT" (Pennsylvania DOT)
- Crash test reports: FHWA/TX-83/416-1F, FHWA/TX-08/408037 (static steel rail anchorage test)
- Example locations: I-80 over Missouri River, I-74 over Mississippi River, I-35 NB to US 30 WB Ramp H Flyover
- W:\Highway\Bridge\MethodsSection\Barriers\Rail Guide\1\_1997 FHWA Memo Rails+NCHRP 350\TX T80HT

# Section 1: Metal Tube and Channel Rails

## Acceptable Variations:

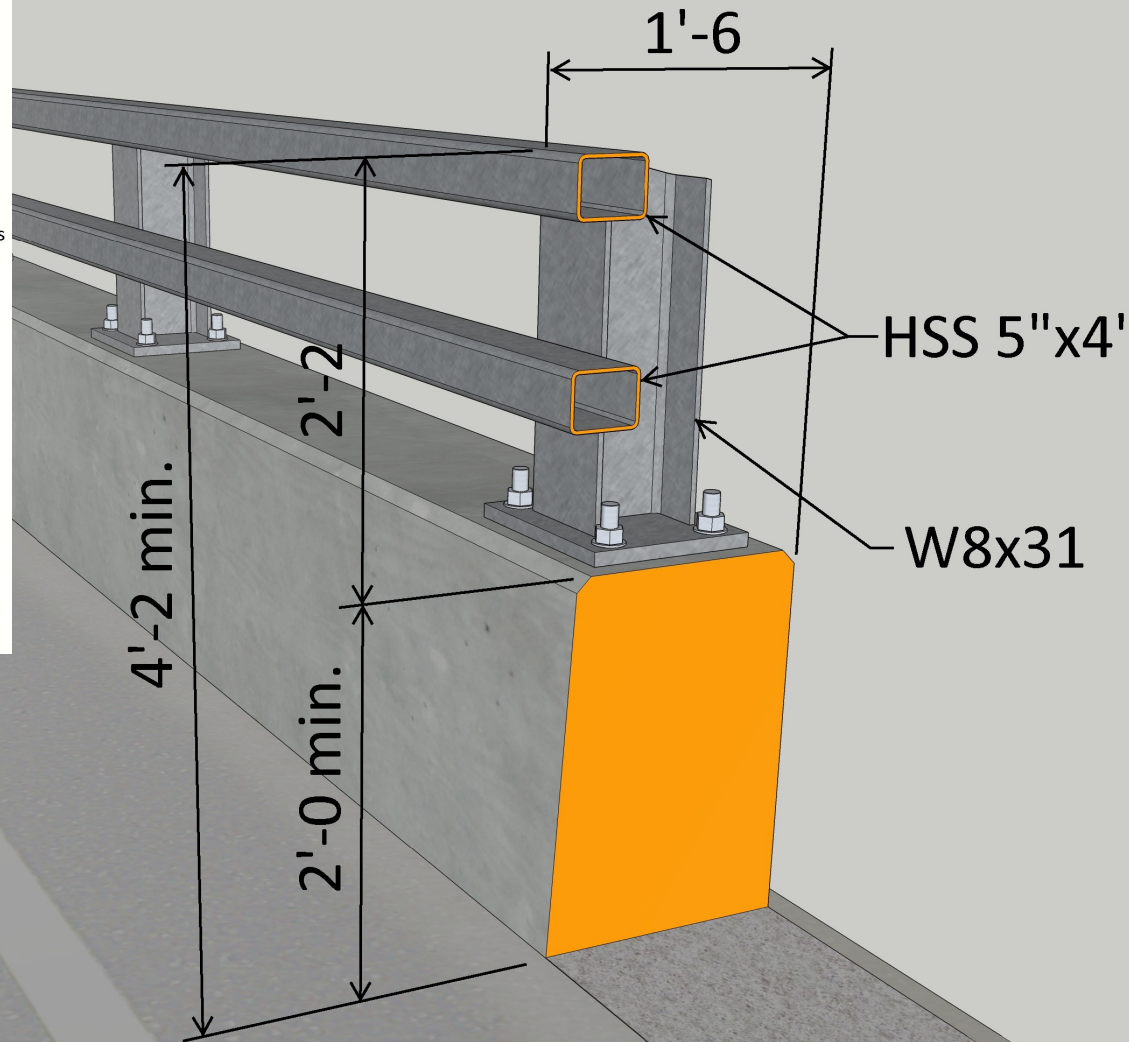
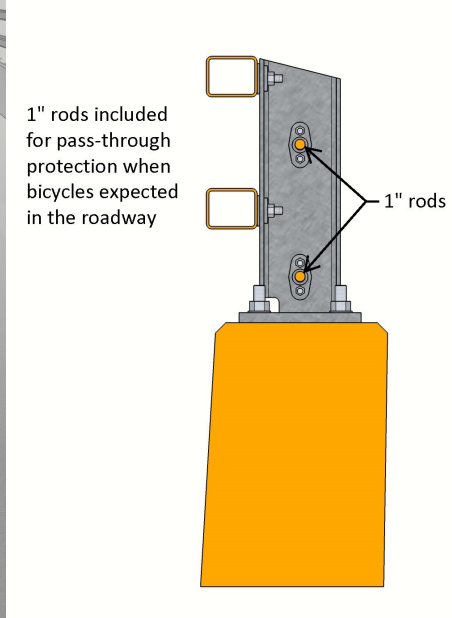

Note: steel rail posts spaced at 7'-6 c.-c. max.

## PennDOT PA

- MASH 2016, TL-5
- AASHTO B.RH.01 Code: M185
- Note: measured height must be 4'-2 min. at all points on bridge
- Crash test reports: Test Report No. 609591-03 (TTI)
- Example location: IA 9 over Mississippi River at Lansing (Allamakee County Design 124)
- W:\Highway\Bridge\MethodsSection\Barriers\Rail Guide\3\_MASH Era Rails\_ also see MASH\PennDOT PA

# Section 1: Metal Tube and Channel Rails

## Acceptable Variations:

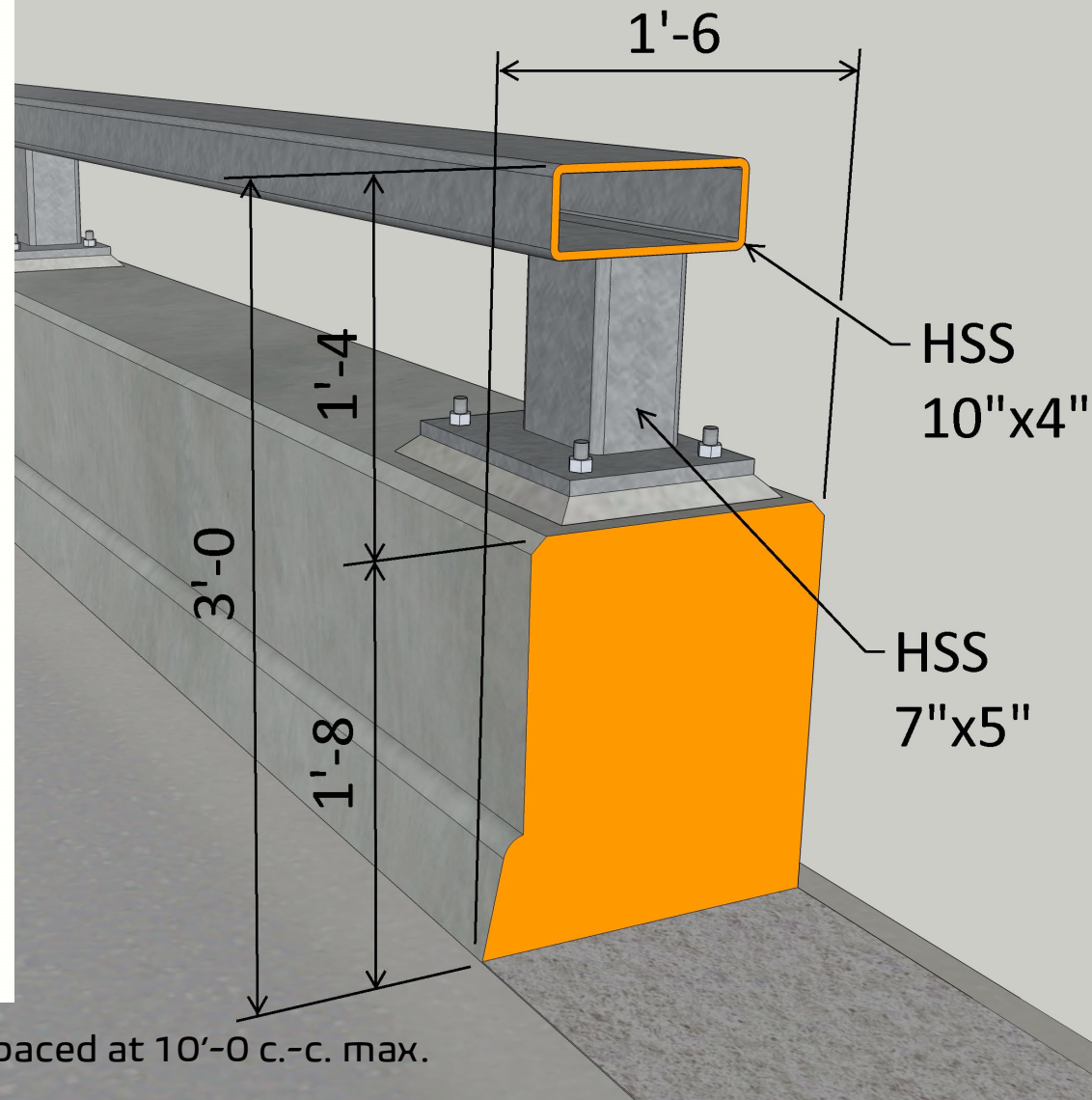
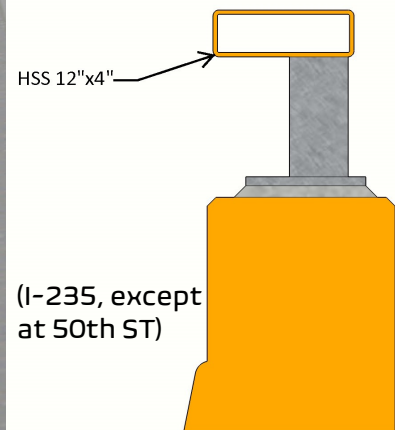
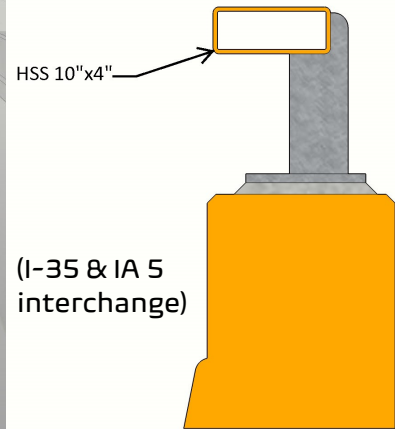

Note: steel rail posts spaced at 10'-0 c.-c. max.

## MN Type 3 Combination Railing

- NCHRP 350 TL-4; (see 1997 FHWA Memo)
- Current MASH equivalency: TL-4 based on height, but geometry (for steel rail on concrete parapet < 24") and strength may require verification; see TRP-03-403-21 for modified version crash tested to MASH TL-4 in 2021
- AASHTO B.RH.01 Code: 3504
- Notes: measured height must be 3'-0 min. at all points on bridge; 10"x4" top tube was changed to 12"x4" for constructability
- Crash test reports: TRP-03-53-96
- Example locations: IA 5 and I-35 Interchange, I-235 overhead bridges, I-235 ML over Des Moines River
- W:\Highway\Bridge\MethodsSection\Barriers\Rail Guide\1\_1997 FHWA Memo Rails+NCHRP 350MN Type 3 Combo Rail

# Section 1: Metal Tube and Channel Rails

## IL 2399 2-Rail on Curb

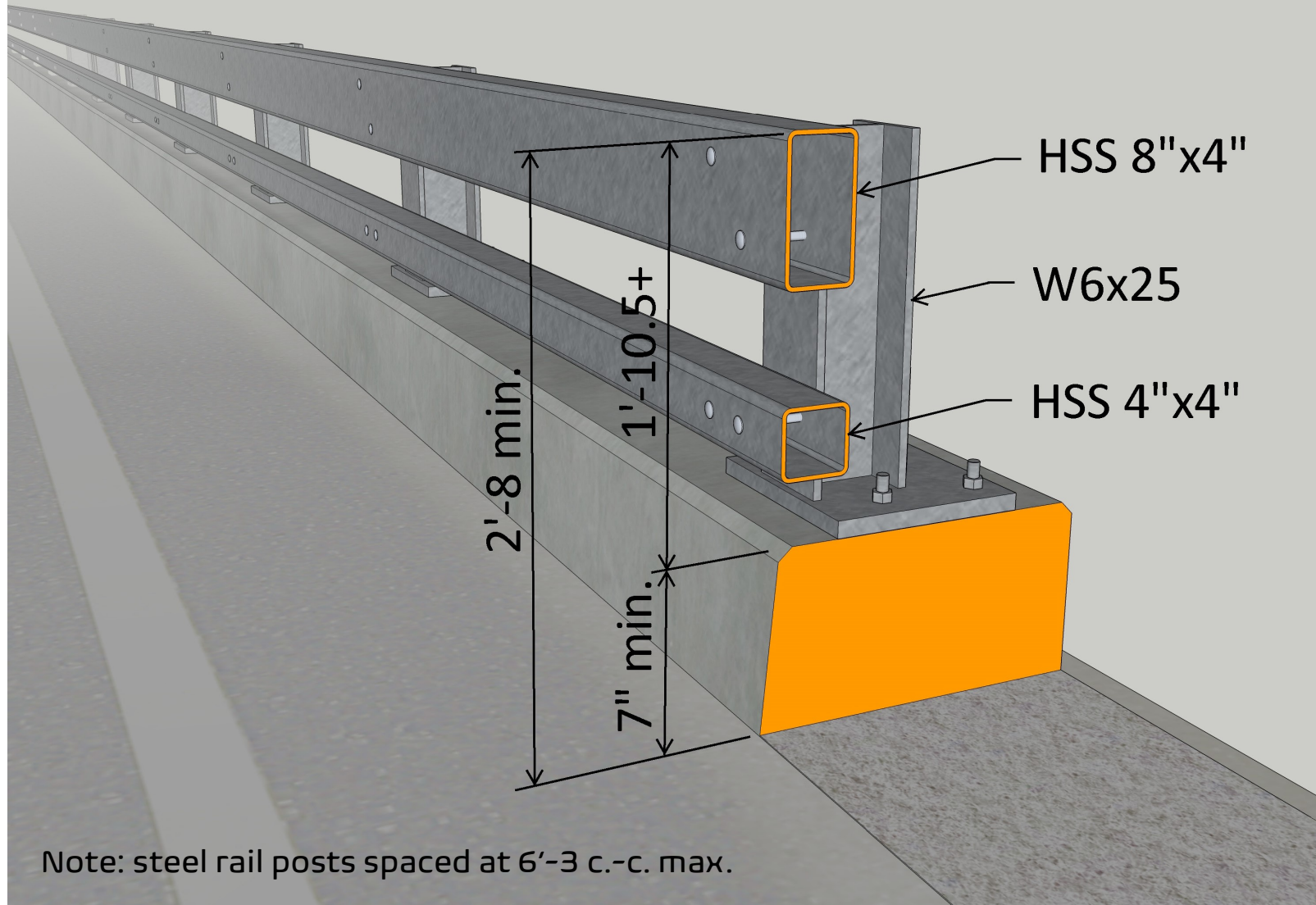

- 1989 Guide Specification for Bridge Railings , PL-2 (equivalent to NCHRP 350 TL-4; see 1997 FHWA Memo)
- Current MASH Equivalency: TL-3 based on 29" min. height exceeded, but geometry (for steel rail on concrete parapet < 24") and strength may require verification; see NCHRP 20-07(395)
- AASHTO B.RH.01 Code: 892
- Note: measured height must be 2'-8 min. at all points on bridge
- Crash test reports: FHWA-RD-93-058
- Example locations: IA 14 over Red Rock Reservoir
- W:\Highway\Bridge\MethodsSection\Barriers\Rail Guide\1\_1997 FHWA Memo Rails+NCHRP 350\IL 2399 2-Rail on Curb

# Section 1: Metal Tube and Channel Rails

## IL 2399 Side-Mounted

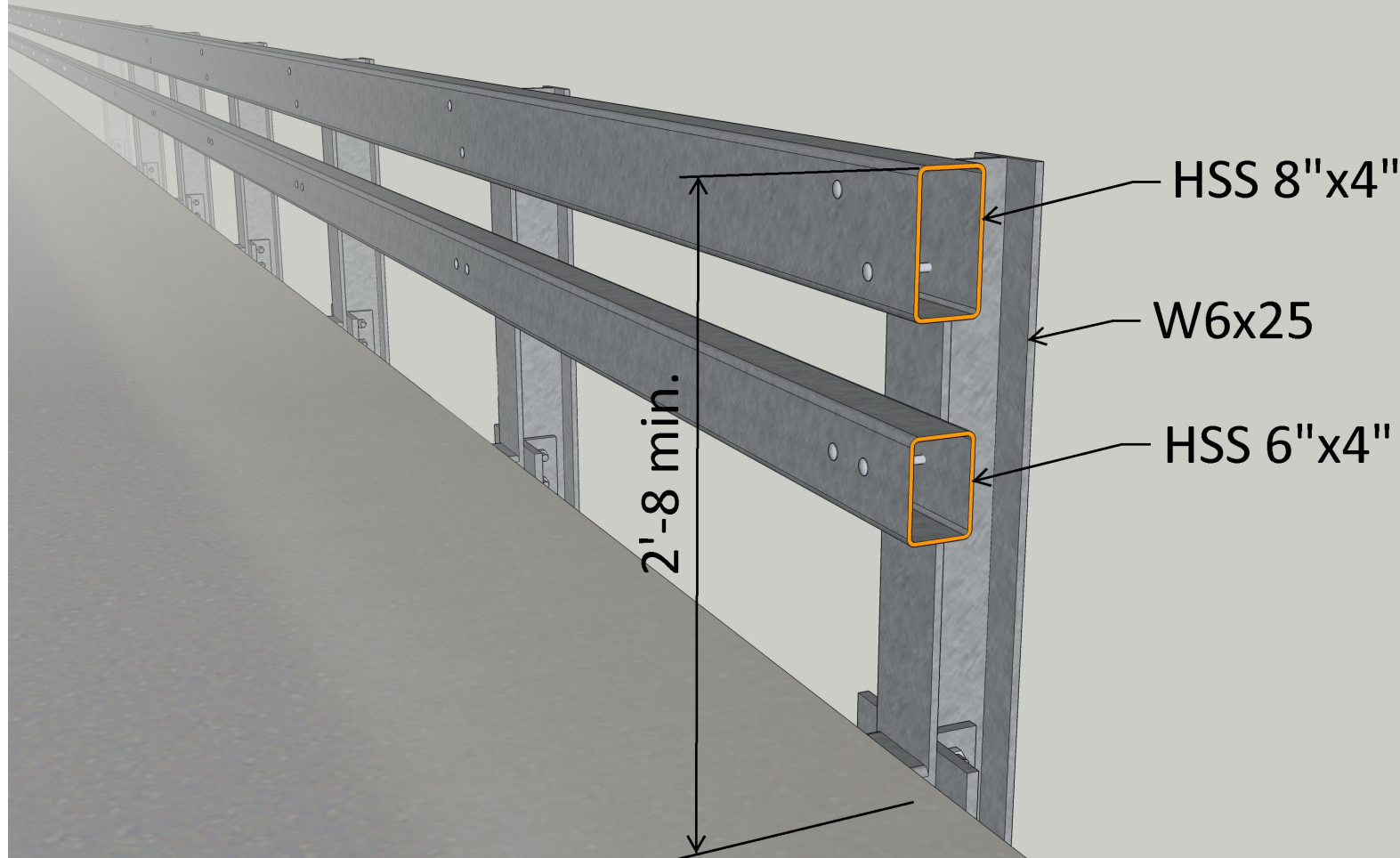

- 1989 Guide Specification for Bridge Railings , PL-2 (equivalent to NCHRP 350 TL-4; see 1997 FHWA Memo)
- Current MASH Equivalency: TL-3 based on 29" min. height exceeded, but geometry of steel rail and strength may require verification; see NCHRP 20-07(395)
- AASHTO B.RH.01 Code: 892
- Note: measured height must be 2'-8 min. at all points on bridge
- Crash test reports: FHWA-RD-93-066
- Example location: IA 3 over Branch 19, Pocahontas County Design No. 118
- W:\Highway\Bridge\MethodsSection\Barriers\Rail Guide\1\_1997 FHWA Memo Rails+NCHRP 350\IL 2399 Side-Mount

Note: steel rail posts spaced at 6'-3 c.-c. max.

# Section 1: Metal Tube and Channel Rails

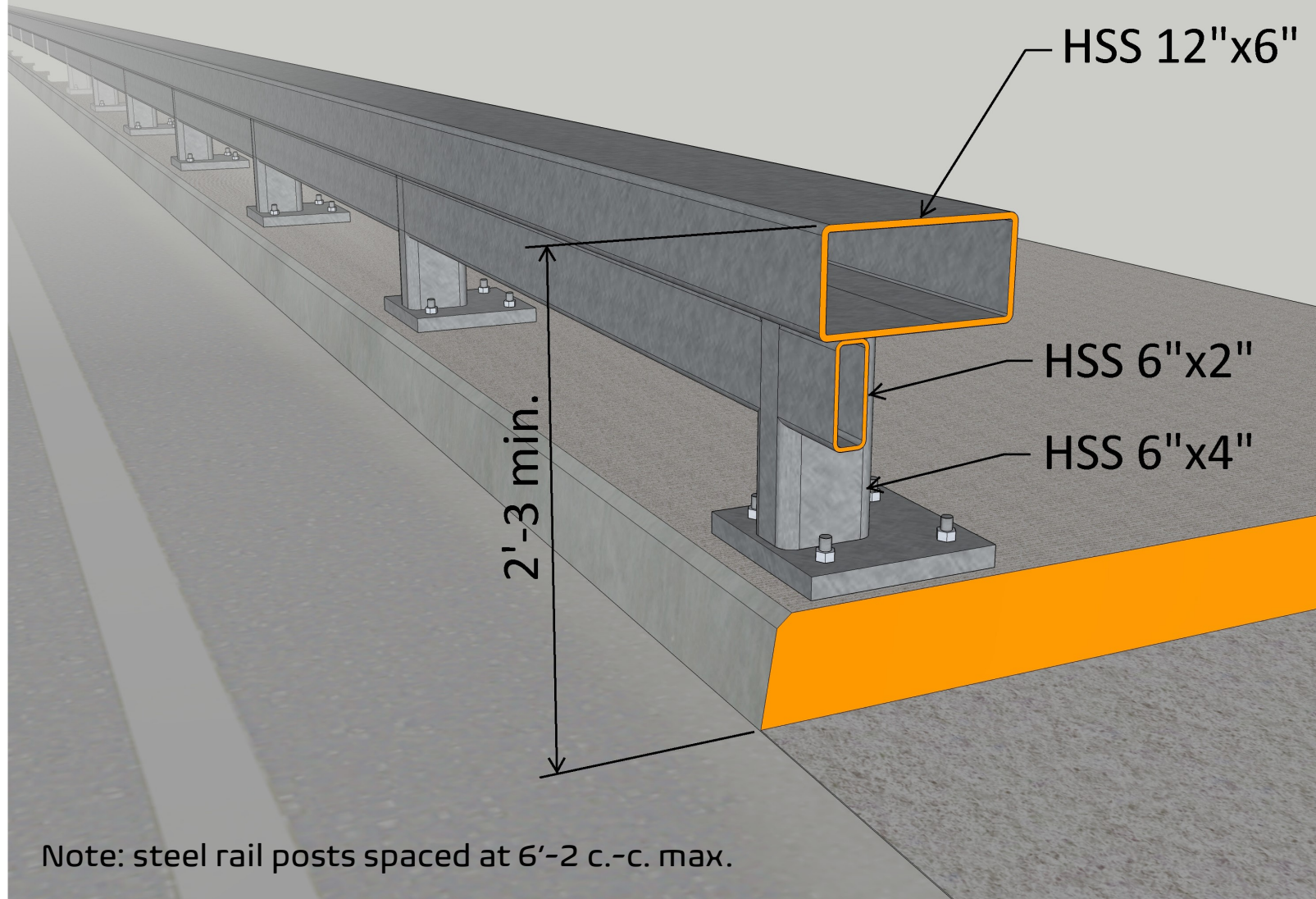

Note: steel rail posts spaced at 6'-2 c.-c. max.

## Washington DC Historic Retrofit

- NCHRP Report 230, PL-1 (equivalent to NCHRP 350 TL-2; see 1997 FHWA Memo)
- Current MASH Equivalency: unknown
- AASHTO B.RH.01 Code: 2301
- Note: measured height must be 2'-3 min. at all points on bridge; used as a separation barrier only
- Crash test reports: FHWA-RD-98-040
- Example location: Business US 20/Gordon Drive Viaduct, Woodbury County Design No. 107
- W:\Highway\Bridge\MethodsSection\Barriers\Rail Guide\1\_1997 FHWA Memo Rails+NCHRP 350\Wash DC Hist Retrofit



# Section 1: Metal Tube and Channel Rails

## Acceptable Variations:

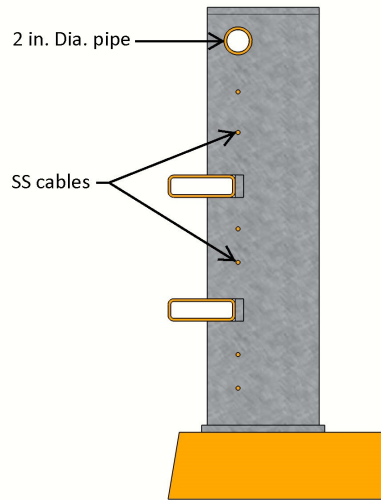

This modification to a combination traffic and pedestrian railing is allowed only for low speed and low traffic volume conditions; see Des Moines city bridges over DM River

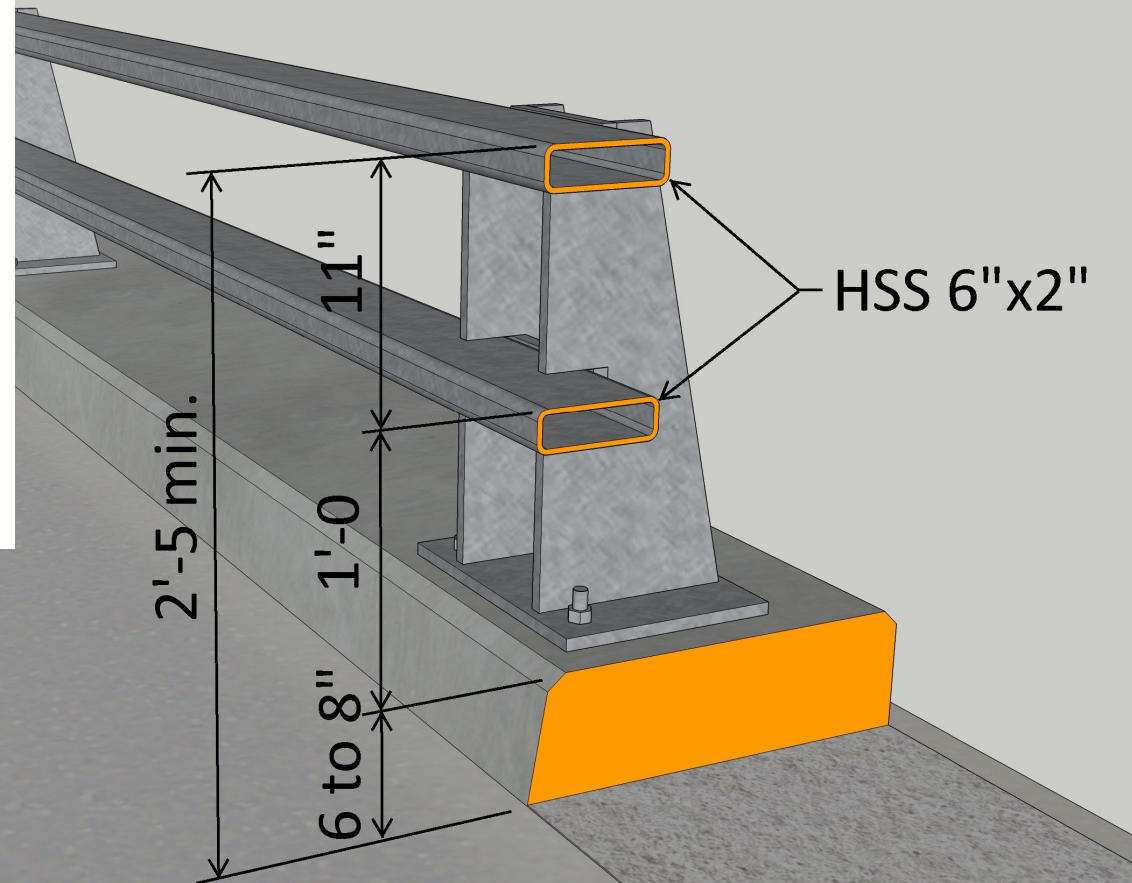

Note: steel rail posts spaced at 10'-0 c.-c. max.

## Wyoming 2-Tube Curb-Mounted Railing

- NCHRP 350 TL-3; (see 1997 FHWA Memo)
- Current MASH equivalency: Unknown; TL-3 compliant based on height and strength, but rail geometry has been assessed as not satisfactory; see NCHRP 20-07(395)
- AASHTO B.RH.01 Code: 3503
- Note: measured height must be 2'-5 min. at all points on bridge
- Crash test reports: Project BR-NBIS(003) Research Report 0368-1, FHWA-RD-96 Project No. 472610-4
- Example locations: Grand Ave over MLK Pkwy, Geo. Washington Carver over Raccoon River, MLK Pkwy over Des Moines River, Grand Ave over Des Moines River
- W:\Highway\Bridge\MethodsSection\Barriers\Rail Guide\1\_1997 FHWA Memo Rails+NCHRP 350\WY 2-Tube on Curb

# Section 1: Metal Tube and Channel Rails

## Steel Round 2-Tube Rail on Curb

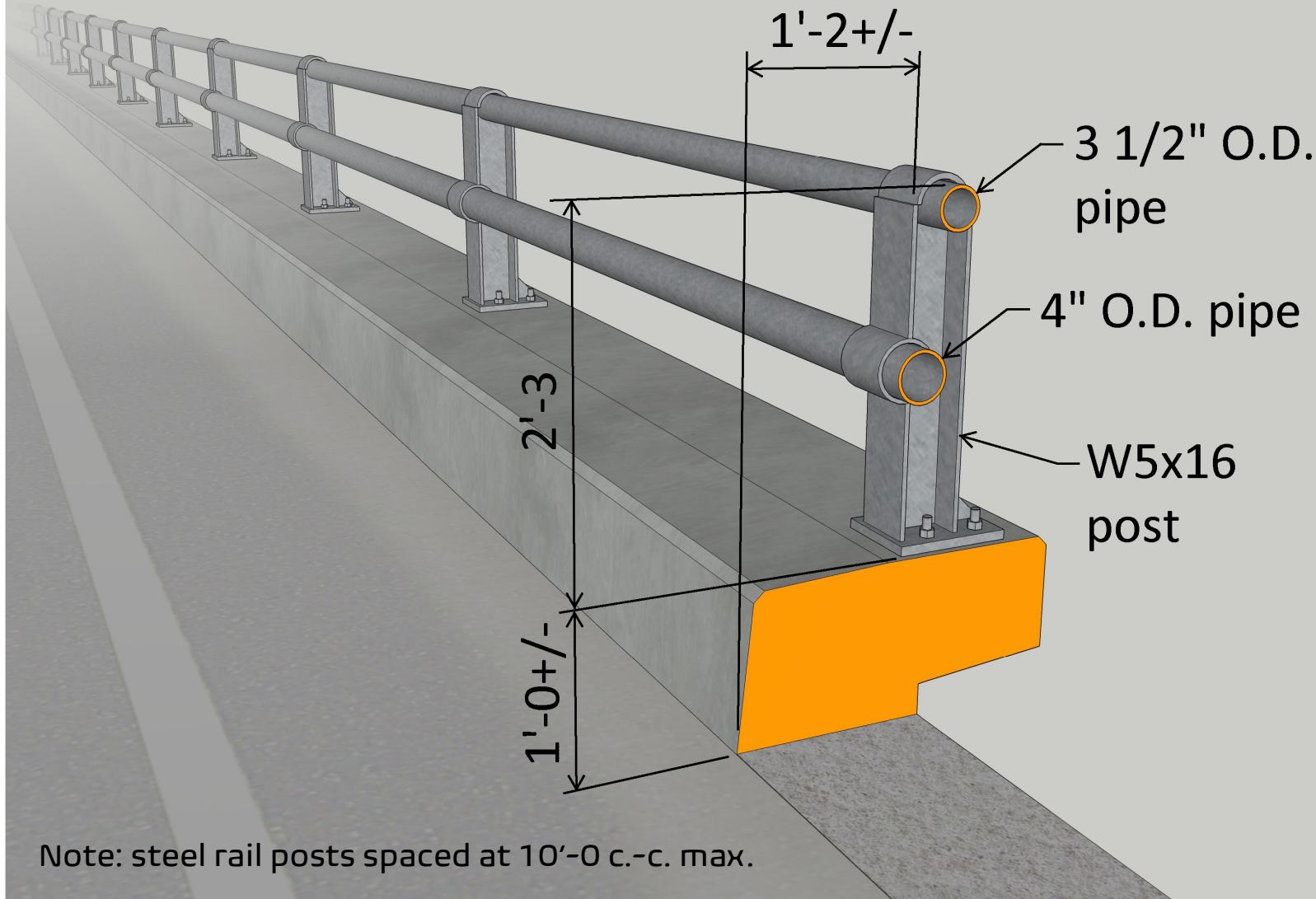

- Test Spec: unknown/not tested
- Rail is not compliant with AASHTO Specifications for Highway Bridges 2.7.1 Vehicular Railings (1" max. vertical misalignment between rails on traffic face)
- Current MASH equivalency: unknown
- AASHTO B.RH.01 Code: S60
- Note: currently (as of 2023) in service on 1 bridge with a 1960 design number
- Example location: Jasper County Design 1060, W. 62nd Street S. over I-80
- W:\Highway\Bridge\MethodsSection\Barriers\Rail Guide\2\_Other Pre-MASH Rails Used by DOT\Steel Round 2-Tube Rail on Curb

Note: steel rail posts spaced at 10'-0 c.-c. max.

# Section 1: Metal Tube and Channel Rails

## Steel Round 3-Tube Rail on Curb

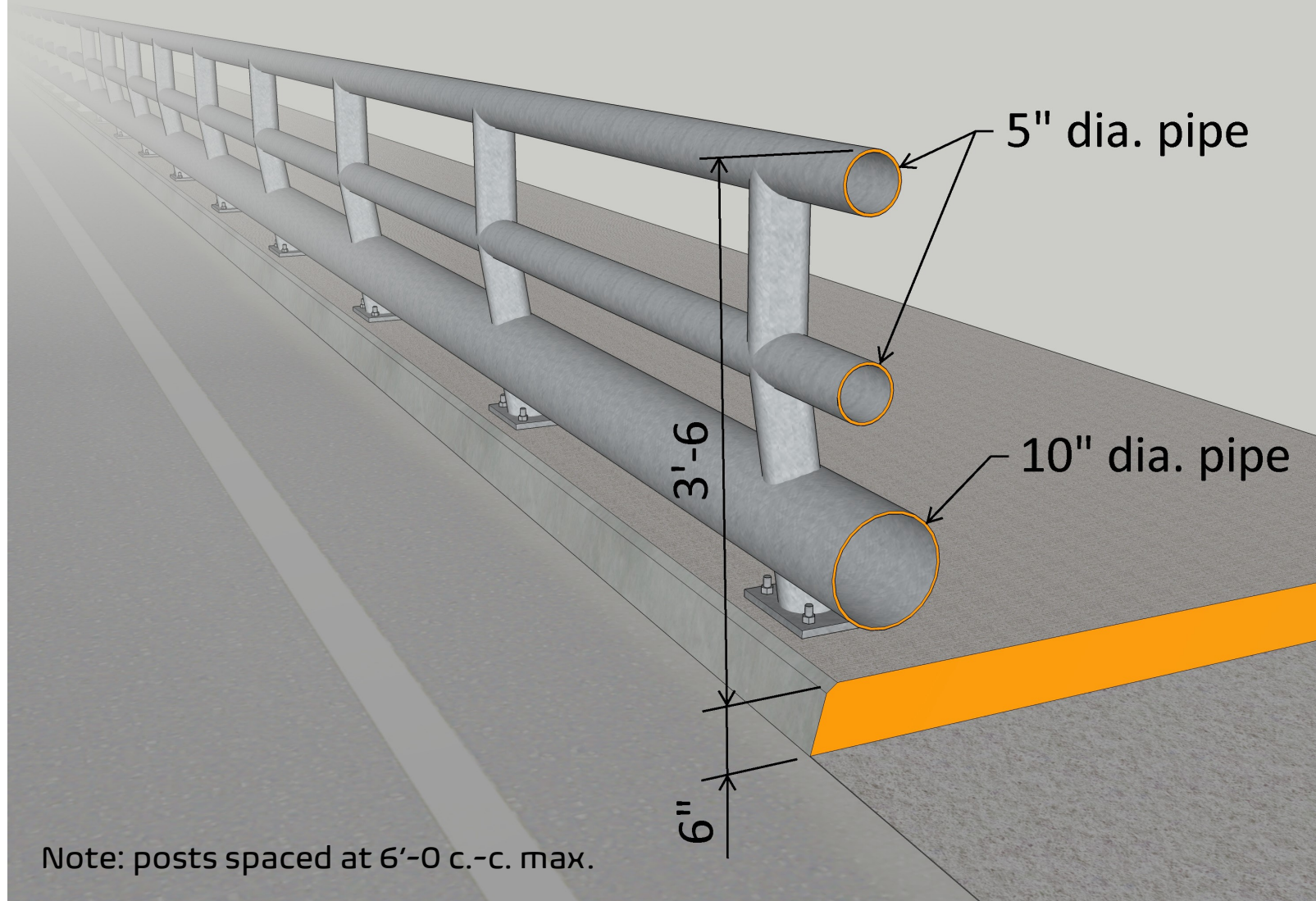

- Test Spec: unknown/not tested
- Rail geometry may be compliant with AASHTO Specifications for Highway Bridges 2.7.1 Vehicular Railings, but other factors unknown
- Current MASH equivalency: unknown
- AASHTO B.RH.01 Code: S04
- Note: designed for use as a separation barrier in an urban area with TL-1 roadway characteristics only; currently (as of 2023) in service on 1 bridge built in 2004
- Example location: Iowa Hwy 1/Burlington Street over Ralston Creek, Iowa City, Johnson Co.
- W:\Highway\Bridge\MethodsSection\Barriers\Rail Guide\4\_Pre-MASH Rails used in IA by others\Steel Round 3-Tube Rail on Curb

# Section 1: Metal Tube and Channel Rails

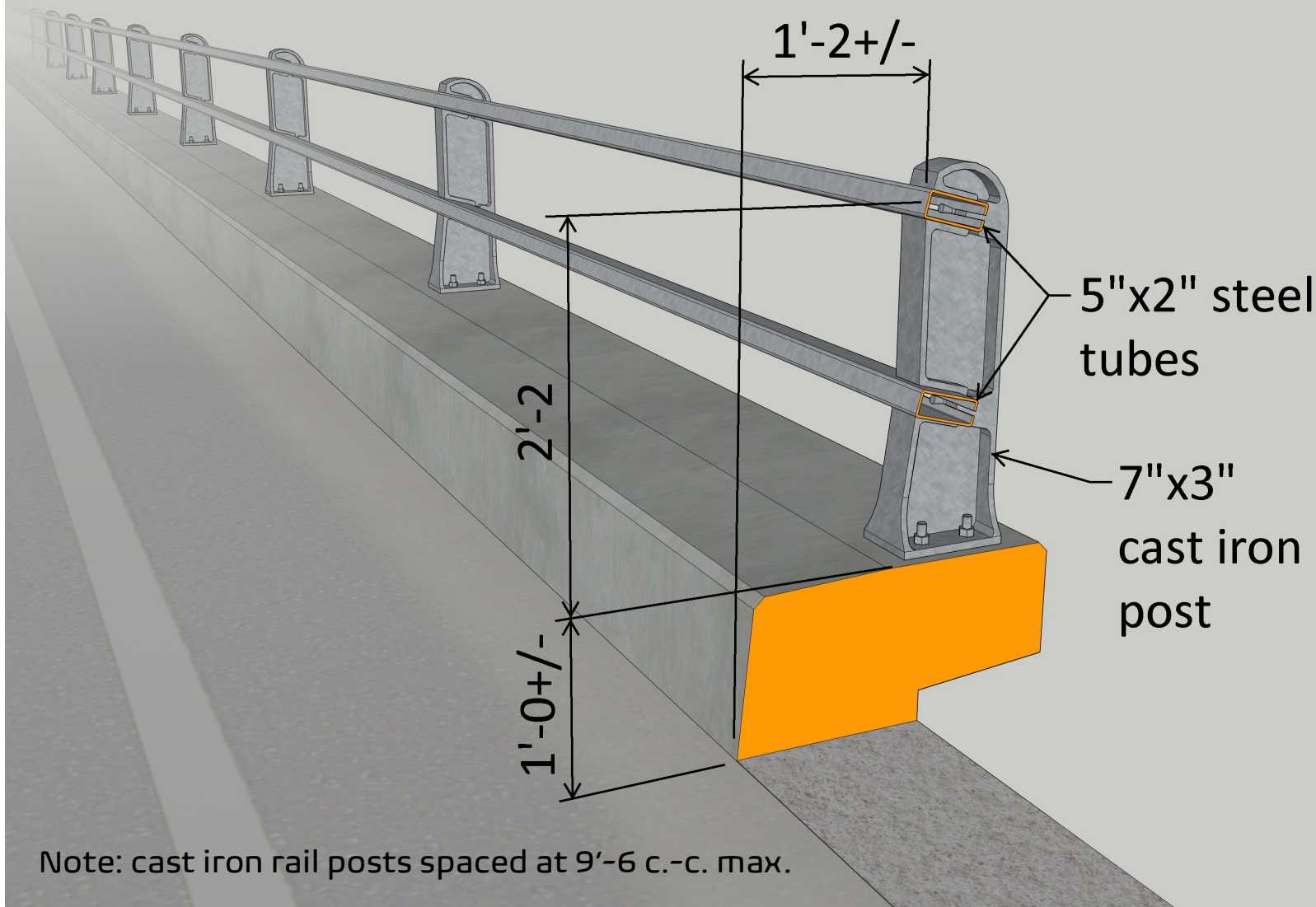

## Steel Rectangular 2-Tube Rail on Curb

- Test Spec: unknown/not tested
- Rail geometry may be compliant with AASHTO Specifications for Highway Bridges 2.7.1 Vehicular Railings for height, rail spacing and vertical alignment, but there is inadequate setback distance to the support posts and strength of malleable iron cast posts is unknown
- Current MASH equivalency: unknown
- AASHTO B.RH.01 Code: S61
- Note: currently (as of 2023) in service on 1 bridge with a 1961 design number
- Example location: Iowa County Design 3261, R Ave./Co. Rd. W16 over I-80
- W:\Highway\Bridge\MethodsSection\Barriers\Rail Guide\2\_Other Pre-MASH Rails Used by DOT\Steel Rect 2-Tube Rail on Curb

# Section 1: Metal Tube and Channel Rails

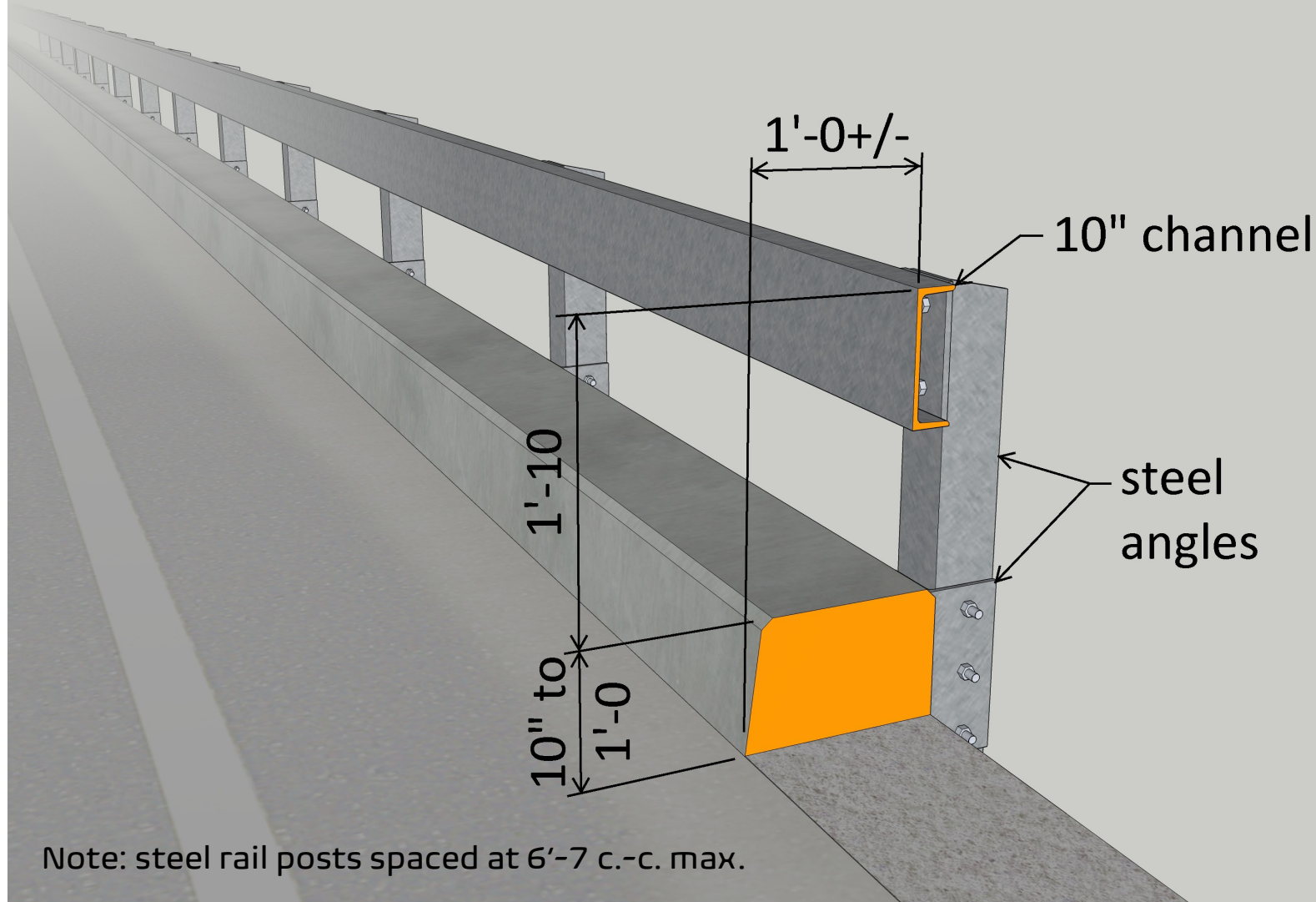

## Steel Channel 1-Rail on Curb

- Test Spec: unknown/not tested
- Rail geometry is not compliant with AASHTO Specifications for Highway Bridges 2.7.1 Vehicular Railings (inadequate overall height, inadequate height above curb reference surface)
- Current MASH equivalency: unknown
- AASHTO B.RH.01 Code: S57
- Note: currently (as of 2023) in service on 2 bridges (incl. 1 in a State Park) with Design Nos. ranging from 1957 to 1965
- Example locations: bridge over Frog Hollow Creek, Volga River S.P., Fayette Co.; 440th Ave bridge over side ditch along US 18, Palo Alto Co.)
- W:\Highway\Bridge\MethodsSection\Barriers\Rail Guide\2\_Other Pre-MASH Rails Used by DOT\Steel Channel 1-Rail on Curb

# Section 1: Metal Tube and Channel Rails

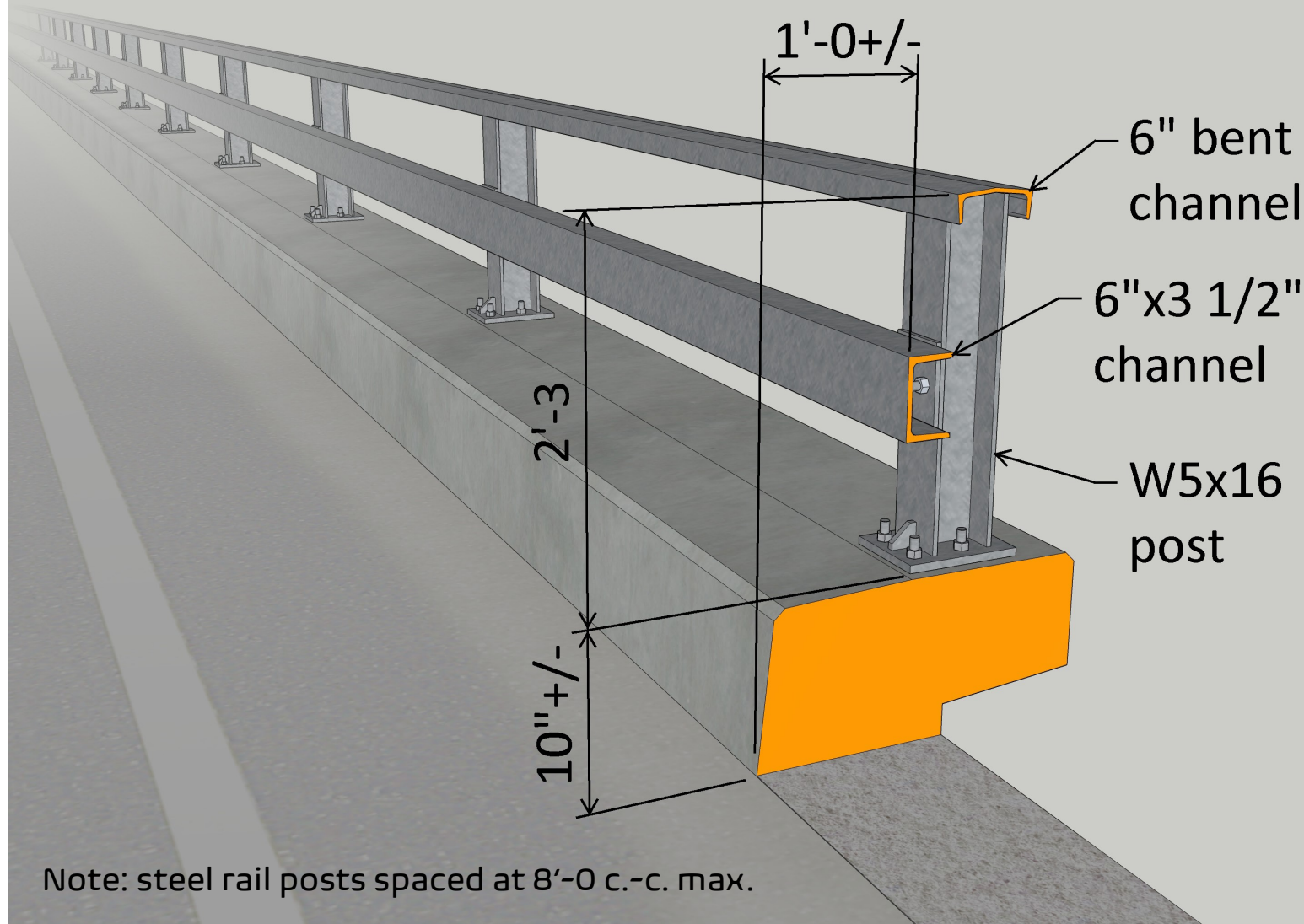

Note: steel rail posts spaced at 8'-0 c.-c. max.

## Steel Channel 2-Rail on Curb (Type 1)

- Test Spec: unknown/not tested
- Rail geometry is not compliant with AASHTO Specifications for Highway Bridges 2.7.1 Vehicular Railings (1" max. vertical misalignment between rails on traffic face)
- Current MASH equivalency: unknown
- AASHTO B.RH.01 Code: S58
- Note: currently (as of 2023) in service on 1 bridge with a 1958 design number
- Example location: Polk Co. Design 4558, NE 38th Street over I-80
- W:\Highway\Bridge\MethodsSection\Barriers\Rail Guide\2\_Other Pre-MASH Rails Used by DOT\Steel Channel 2-Rail on Curb\Type 1

# Section 1: Metal Tube and Channel Rails

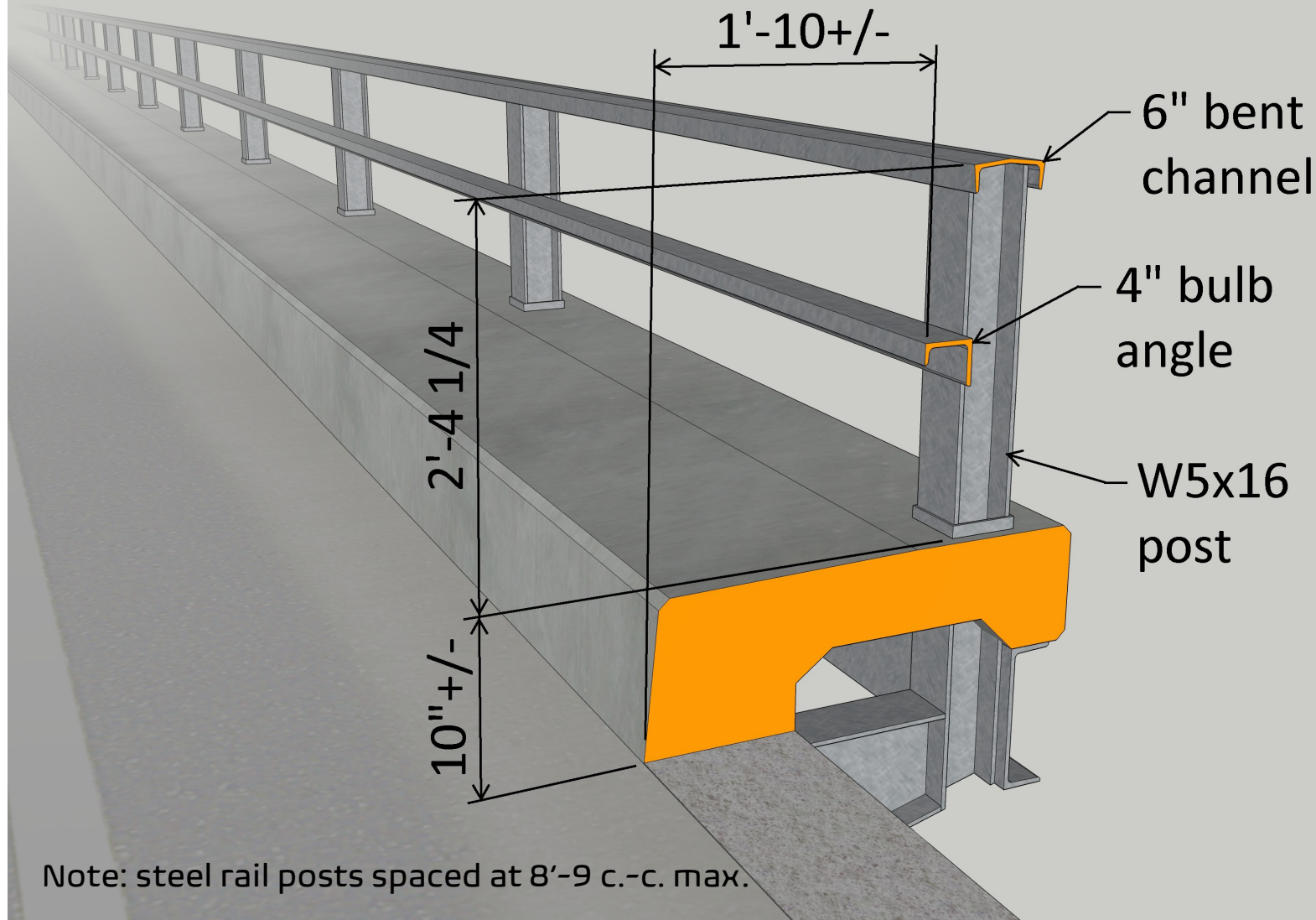

## Steel Channel 2-Rail on Curb (Type 2)

- Test Spec: unknown/not tested
- Rail geometry is not compliant with AASHTO Specifications for Highway Bridges 2.7.1 Vehicular Railings (1" max. vertical misalignment between rails on traffic face)
- Current MASH equivalency: unknown
- AASHTO B.RH.01 Code: S50
- Note: currently (as of 2023) in service on 1 bridge with a 1950 design number
- Example location: Pottawattamie Co. Design 4950, US 59 over the E. Branch of the W. Nishnabotna River
- W:\Highway\Bridge\MethodsSection\Barriers\Rail Guide\2\_Other Pre-MASH Rails Used by DOT\Steel Channel 2-Rail on Curb\Type 2

Note: steel rail posts spaced at 8'-9 c.-c. max.

# Section 1: Metal Tube and Channel Rails

## Steel Channel 2-Rail (no curb; Type 1)

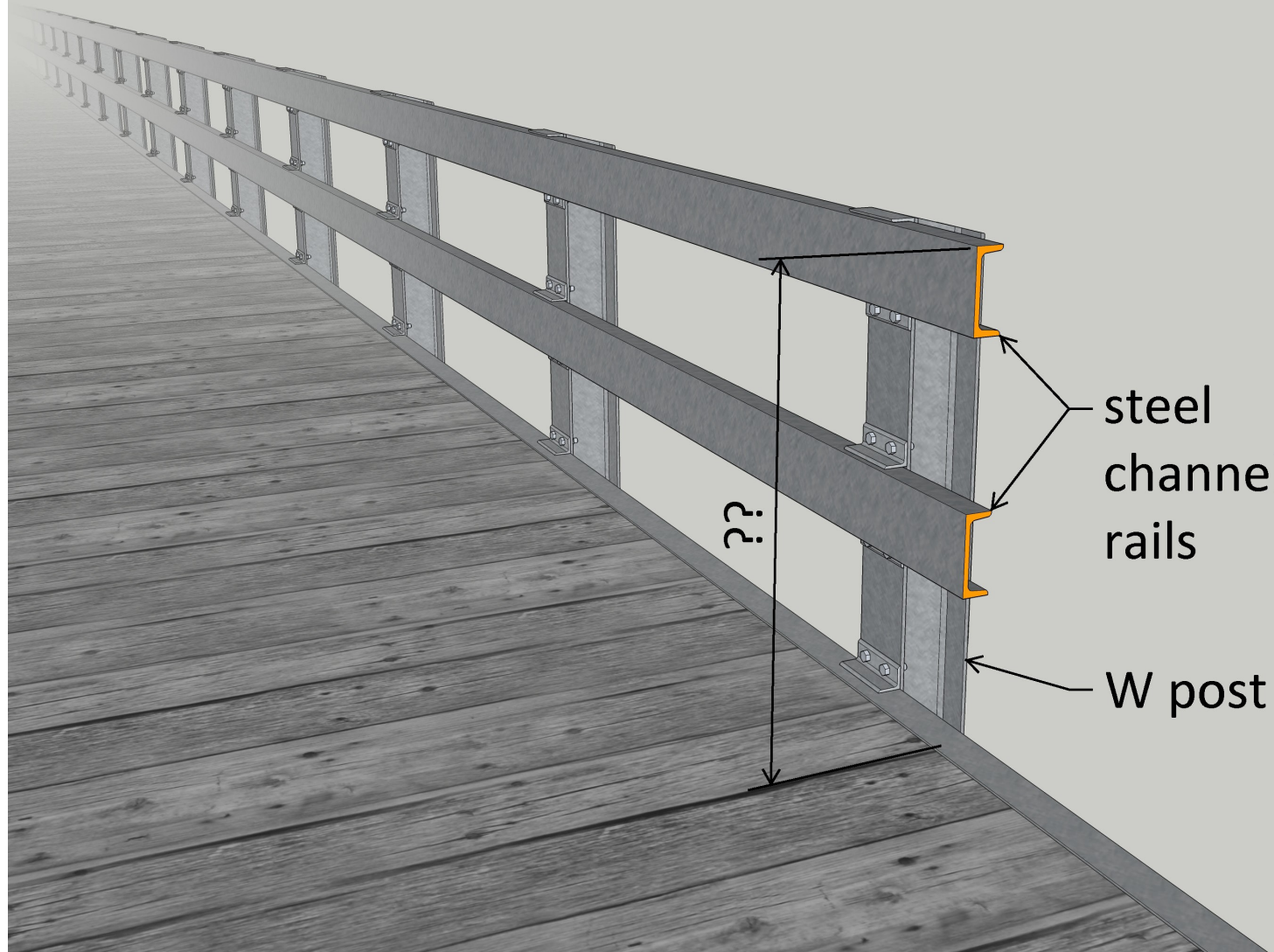

- Test Spec: unknown/not tested
- Rail geometry may be compliant with AASHTO Specifications for Highway Bridges 2.7.1 Vehicular Railings, but strength is unknown
- Current MASH equivalency: unknown
- AASHTO B.RH.01 Code: S97
- Note: currently (as of 2023) in service on 1 bridge built in 1997
- Example location: Lee Co., park road over stream in Shimek State Forest
- W:\Highway\Bridge\MethodsSection\Barriers\Rail Guide\4\_Pre-MASH Rails used in IA by others\Steel Channel 2-Rail



# Section 1: Metal Tube and Channel Rails

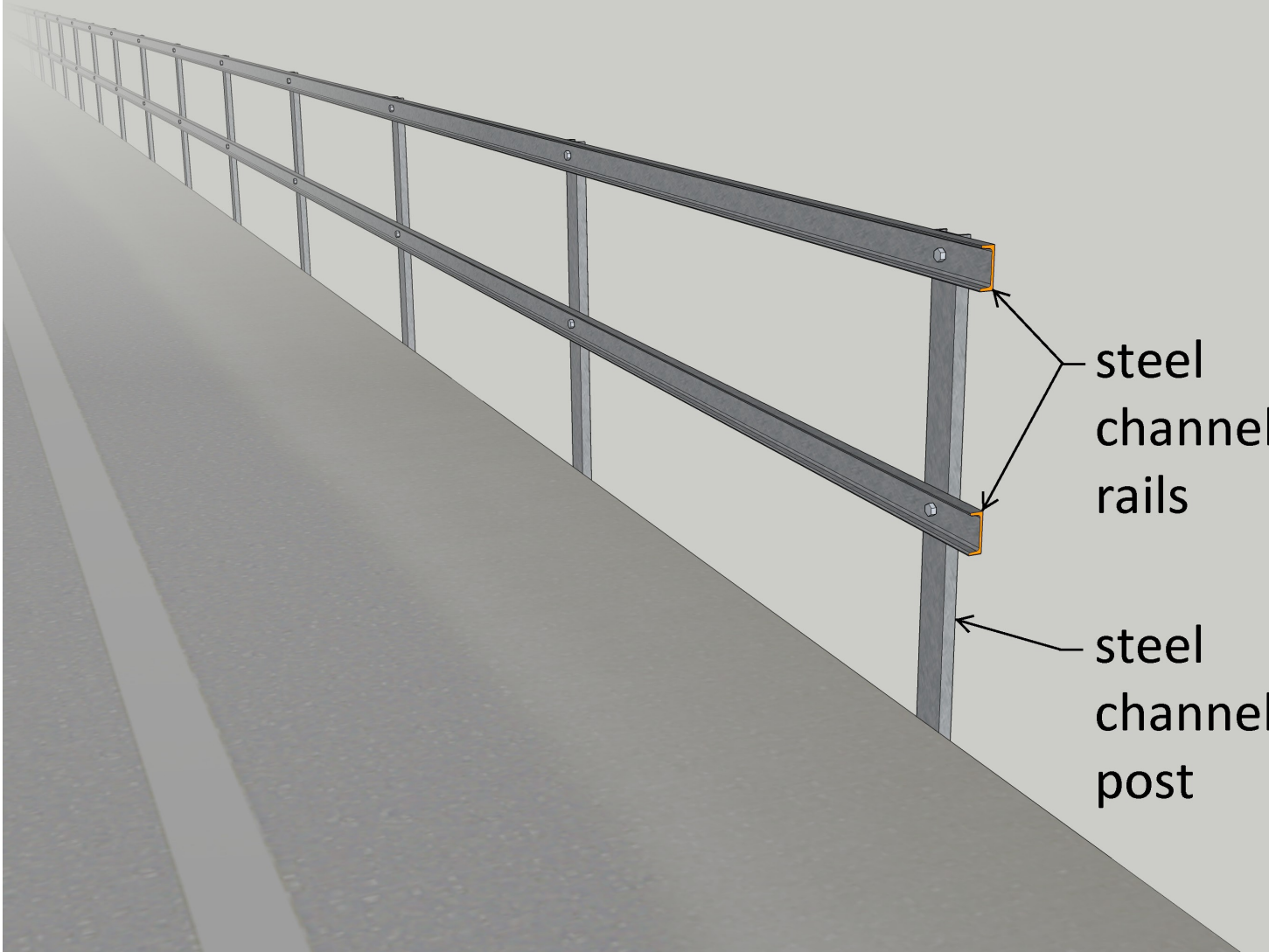

## Steel Channel 2-Rail (no curb; Type 2)

- Test Spec: unknown/not tested
- Rail geometry is not compliant with AASHTO Specifications for Highway Bridges 2.7.1 Vehicular Railings (no parapet, possible excessive space between rail channels, possible excessive distance between supports); strength unknown
- Current MASH equivalency: unknown
- AASHTO B.RH.01 Code: I
- Note: similar rails with light steel construction are likely to receive the same B.RH.01 code
- Example location: local road over Canoe Creek, Winneshiek Co., built 1900
- W:\Highway\Bridge\MethodsSection\Barriers\Rail Guide\4\_Pre-MASH Rails used in IA by others\Steel Channel 2-Rail

# Section 1: Metal Tube and Channel Rails

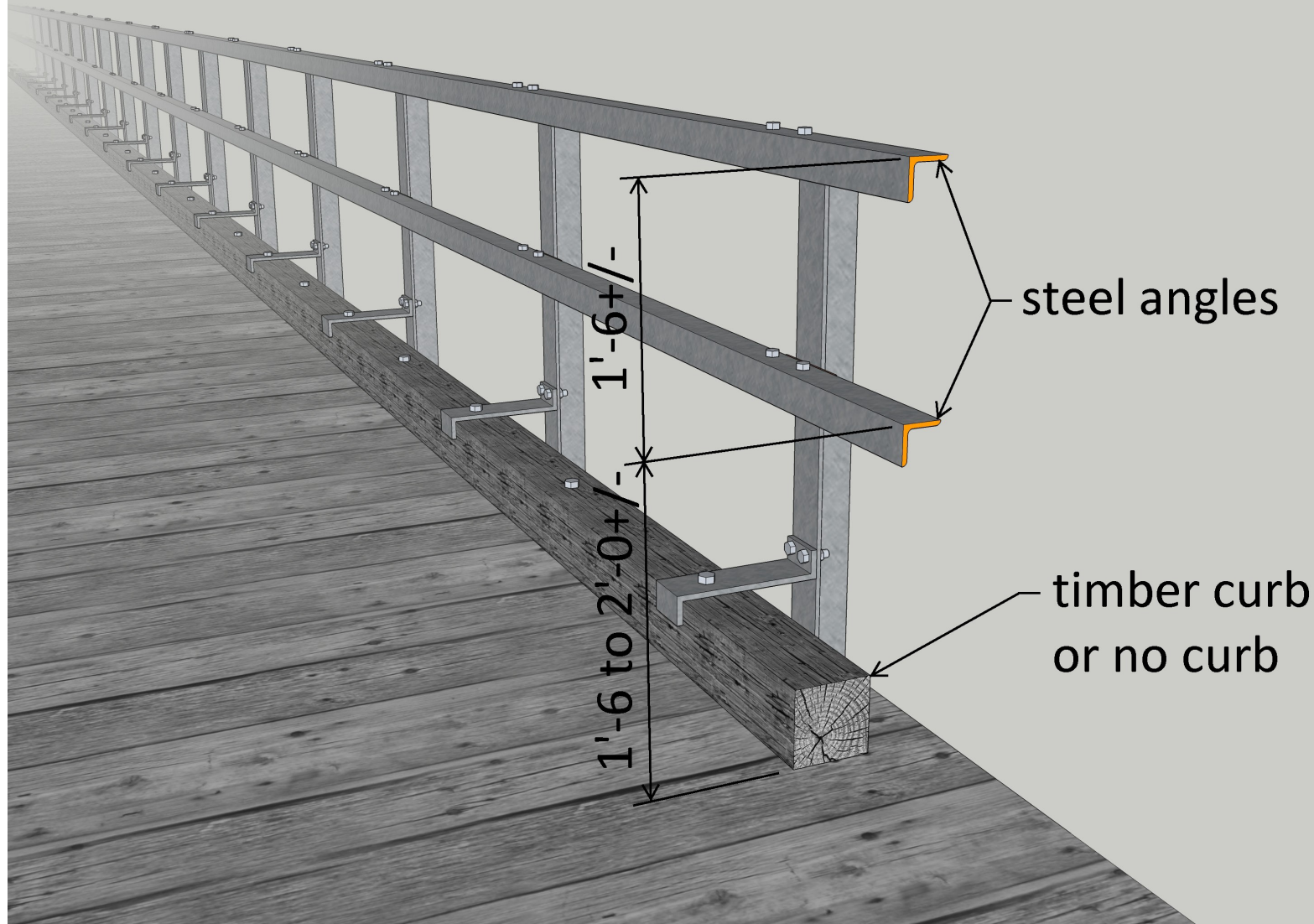

## Steel Angle Rail (Type 1)

- Test spec: unknown/not tested
- Rail geometry is not compliant with AASHTO Specifications for Highway Bridges 2.7.1 Vehicular Railings (inadequate parapet height, possible excessive space between curb and rail angles, vertical misalignment in excess of 1", possible excessive distance between supports); strength unknown
- Current MASH equivalency: unknown
- AASHTO B.RH.01 Code: I
- Note: similar rails with light steel construction are likely to receive the same B.RH.01 code
- Example location: State Park road over stream, Cold Spring S.P., Cass County (built ca. 1900)
- W:\Highway\Bridge\MethodsSection\Barriers\Rail Guide\4\_Pre-MASH Rails used in IA by others\Steel Angles—Various

# Section 1: Metal Tube and Channel Rails

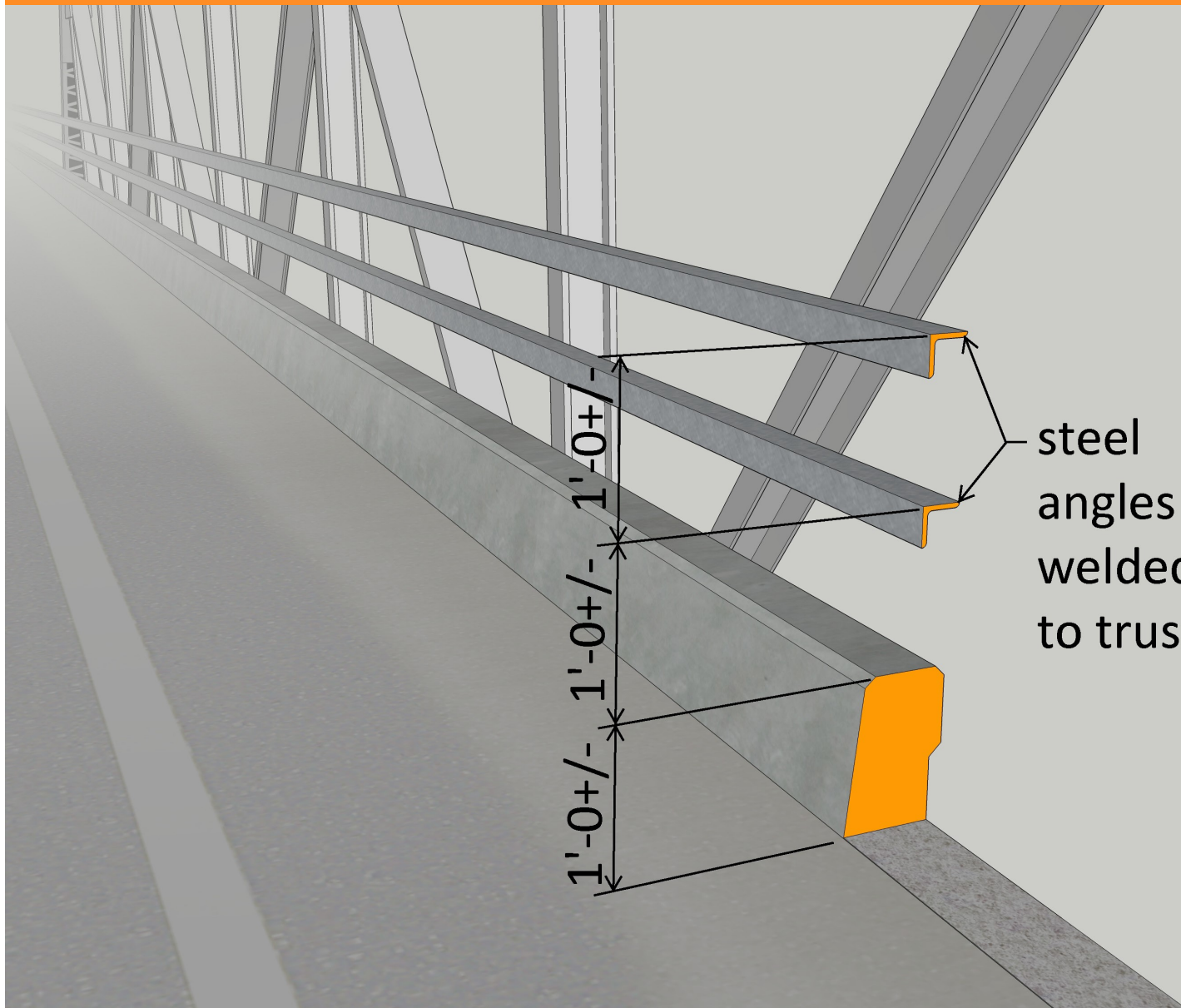

## Steel Angle Rail (Type 2)

- Test spec: unknown/not tested
- Rail geometry is not compliant with AASHTO Specifications for Highway Bridges 2.7.1 Vehicular Railings (inadequate parapet height, possible excessive space between parapet and rail, vertical misalignment in excess of 1"); strength unknown
- Current MASH equivalency: unknown
- AASHTO B.RH.01 Code: I
- Notes: structural steel truss beyond the rail may provide additional performance characteristics that are unknown; currently (as of 2023) in service on one bridge
- Example locations: State Park road over Honey Creek, Lake Darling S.P., Washington County, built 1929
- W:\Highway\Bridge\MethodsSection\Barriers\Rail Guide\4\_Pre-MASH Rails used in IA by others\Steel Angles—Various

# Section 1: Metal Tube and Channel Rails

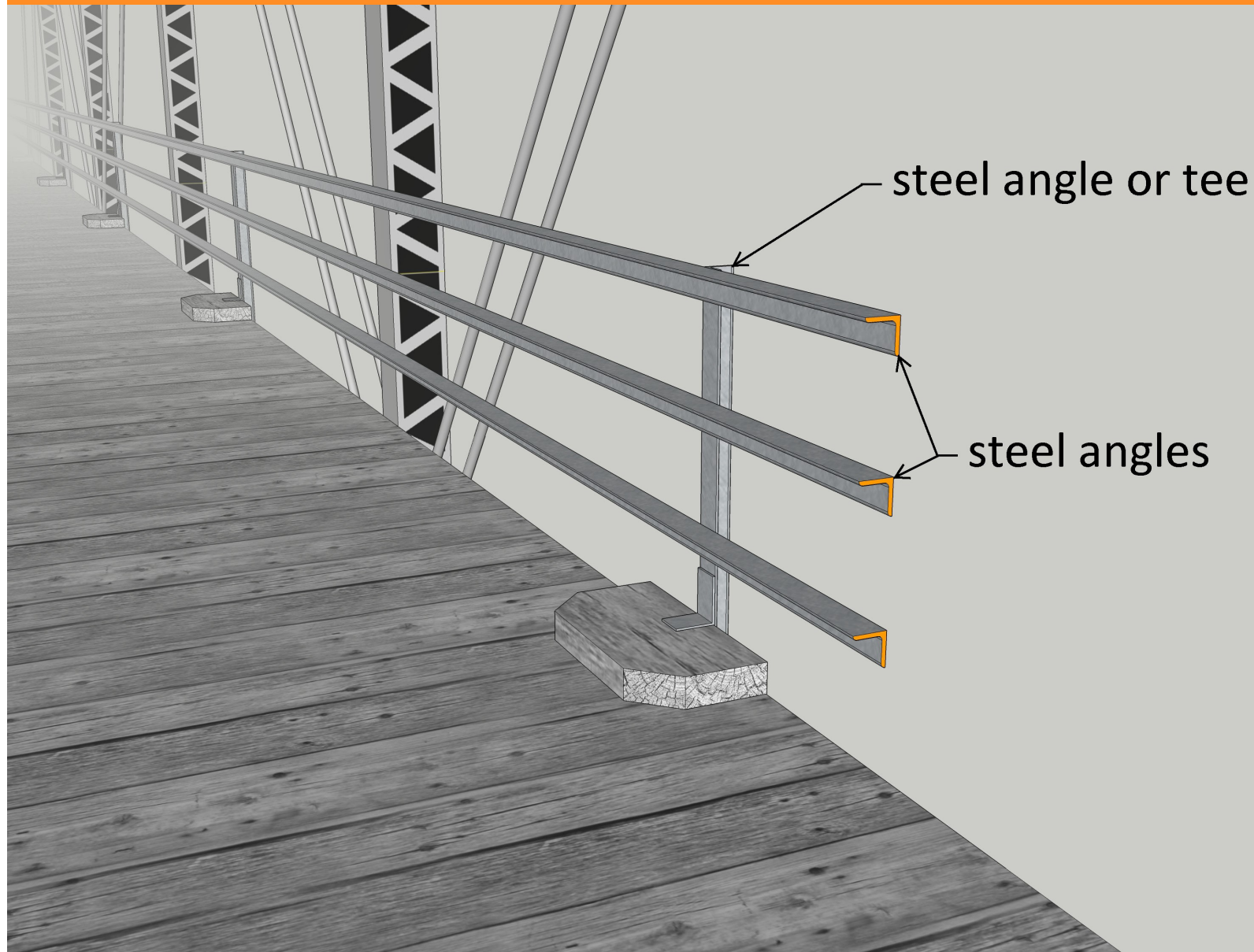

## Steel Angle Rail (Type 3)

- Test spec: unknown/not tested
- Rail geometry is not compliant with AASHTO Specifications for Highway Bridges 2.7.1 Vehicular Railings (no parapet, possible excessive space between steel angle rails, excessive distance between supports); strength unknown
- Current MASH equivalency: unknown
- AASHTO B.RH.01 Code: I
- Notes: structural steel truss beyond the rail may provide additional performance characteristics that are unknown; similar rails with light steel construction are likely to receive the same B.RH.01 code
- Example locations: local road (190th St) over Des Moines River, Humboldt County, built 1911
- W:\Highway\Bridge\MethodsSection\Barriers\Rail Guide\4\_Pre-MASH Rails used in IA by others\Steel Angles—Various

# Section 1: Metal Tube and Channel Rails



## W-Beam on Steel Post

- Test spec: unknown/not tested
- Rail geometry may be compliant with AASHTO Specifications for Highway Bridges 2.7.1 Vehicular Railings, however height must be checked, no parapet is present, possible excessive space between deck and W-beam rail, possible excessive distance between posts; strength is unknown
- Current MASH equivalency: unknown
- AASHTO B.RH.01 Code: I
- Notes: newer installations with heavier posts such as W sections and with short post spacings may represent acceptable performance for low-speed conditions
- Example locations: Bear Creek Rd over Bear Creek, Winneshiek Co.; 2 other local roads over creeks, Winneshiek Co.
- W:\Highway\Bridge\MethodsSection\Barriers\Rail Guide\4\_Pre-MASH Rails used in IA by others\W-Beam on Steel Post

# Section 1: Metal Tube and Channel Rails

## Metal Pipe Railing— Light Construction

- Test spec: unknown/not tested
- Rail type is not compliant with AASHTO Specifications for Highway Bridges 2.7.1 Vehicular Railings (inadequate strength based on assessment against crash tested barrier hardware characteristics)
- Current MASH equivalency: unknown
- AASHTO B.RH.01 Code: I
- Notes: if it can be shown that the rail is positioned entirely outside of clear zone of the adjacent roadway, it is possible the rail could be given a B.RH.01 code of "SYY" with YY being the construction year
- Example location: Memorial Drive over Braddy Creek, Marshalltown, Marshall Co.
- W:\Highway\Bridge\MethodsSection\Barriers\Rail Guide\4\_Pre-MASH Rails used in IA by others\Metal Pipe Railing Light Construction

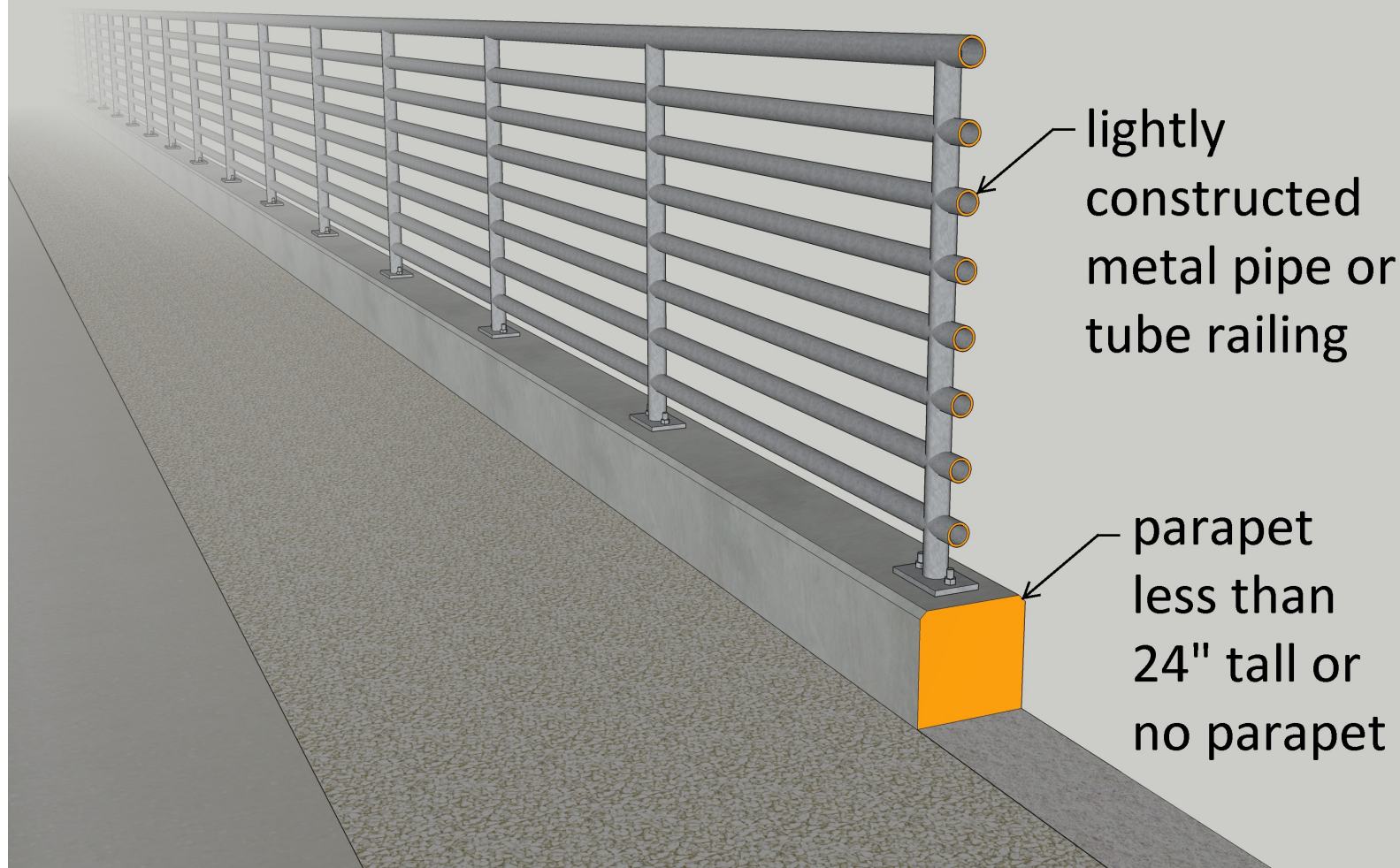

# Section 2: Vertical Face and Open Concrete Rails

## Acceptable Variations:

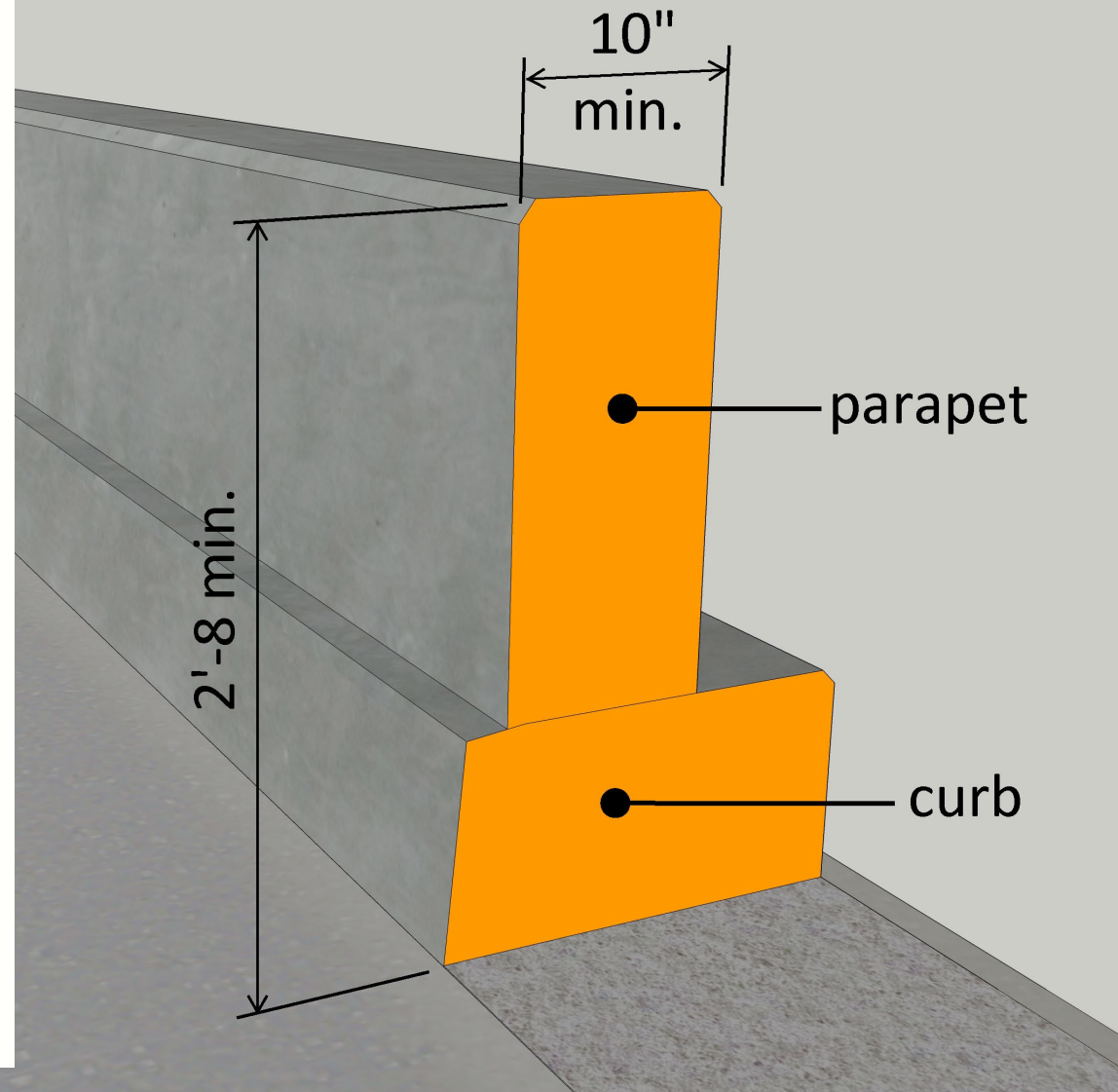
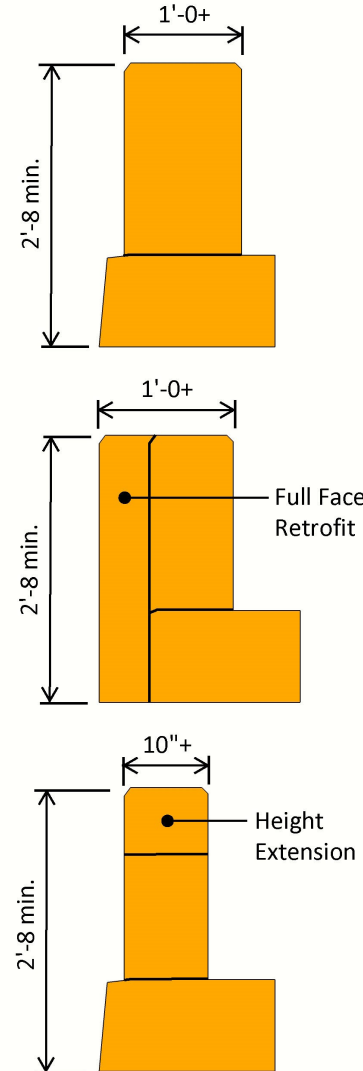

## Iowa Concrete Block Retrofit

- 1989 AASHTO Guide Specification for Bridge Rails, PL-2 (equivalent to NCHRP 350 TL-4; see 1997 FHWA Memo)
- Current MASH equivalency: TL-3 for height and geometry; design check required for strength
- AASHTO B.RH.01 Code: 892
- Notes: measured height must be 2'-8 min. at all points on bridge; width varies (10" min.); do not mistakenly identify the full face retrofit (see Acceptable Variations at left) as a 32-in Vertical Concrete Parapet, which does not have a curb
- Crash test reports: TRP-03-15-88, TRP-03-19-90
- W:\Highway\Bridge\MethodsSection\Barriers\Rail Guide\1\_1997 FHWA Memo Rails+NCHRP 350\Iowa Conc Block Retrofit

## Section 2: Vertical Face and Open Concrete Rails

Acceptable Variations:

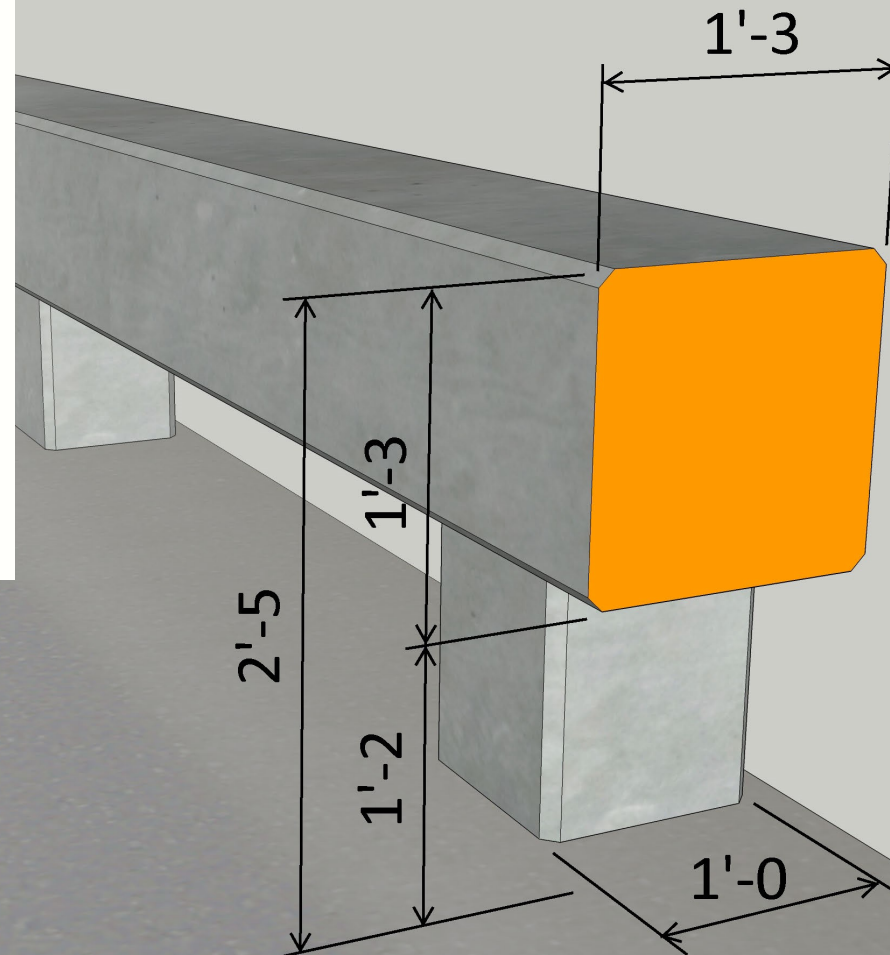
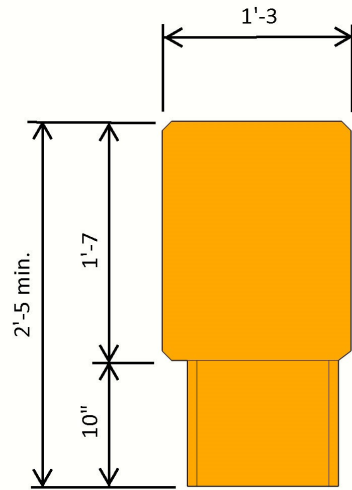

Note: 1'-0 x 1'-0 posts set back 2" from traffic face, spaced at 7'-0 c.-c.

### Iowa Concrete Beam and Post (pre-2006)

- 1989 Guide Specifications for Bridge Railings, PL-2 (equivalent to NCHRP Report 350 TL-4)
- Current MASH equivalency: unknown
- AASHTO B.RH.01 Code: 892
- Notes: measured height must be 2'-5 min. at all points on bridge; note the dimensional differences to the 2006 beam and post rail
- Crash test reports: FHWA-RD-89-119, TRP-03-28-091, TRP-03-51-95
- Example location: north entrance to Pammel State Park, Madison Co. (2002)
- W:\Highway\Bridge\MethodsSection\Barriers\Rail Guide\1\_1997 FHWA Memo Rails+NCHRP 350\Iowa Conc Beam and Post



## Section 2: Vertical Face and Open Concrete Rails

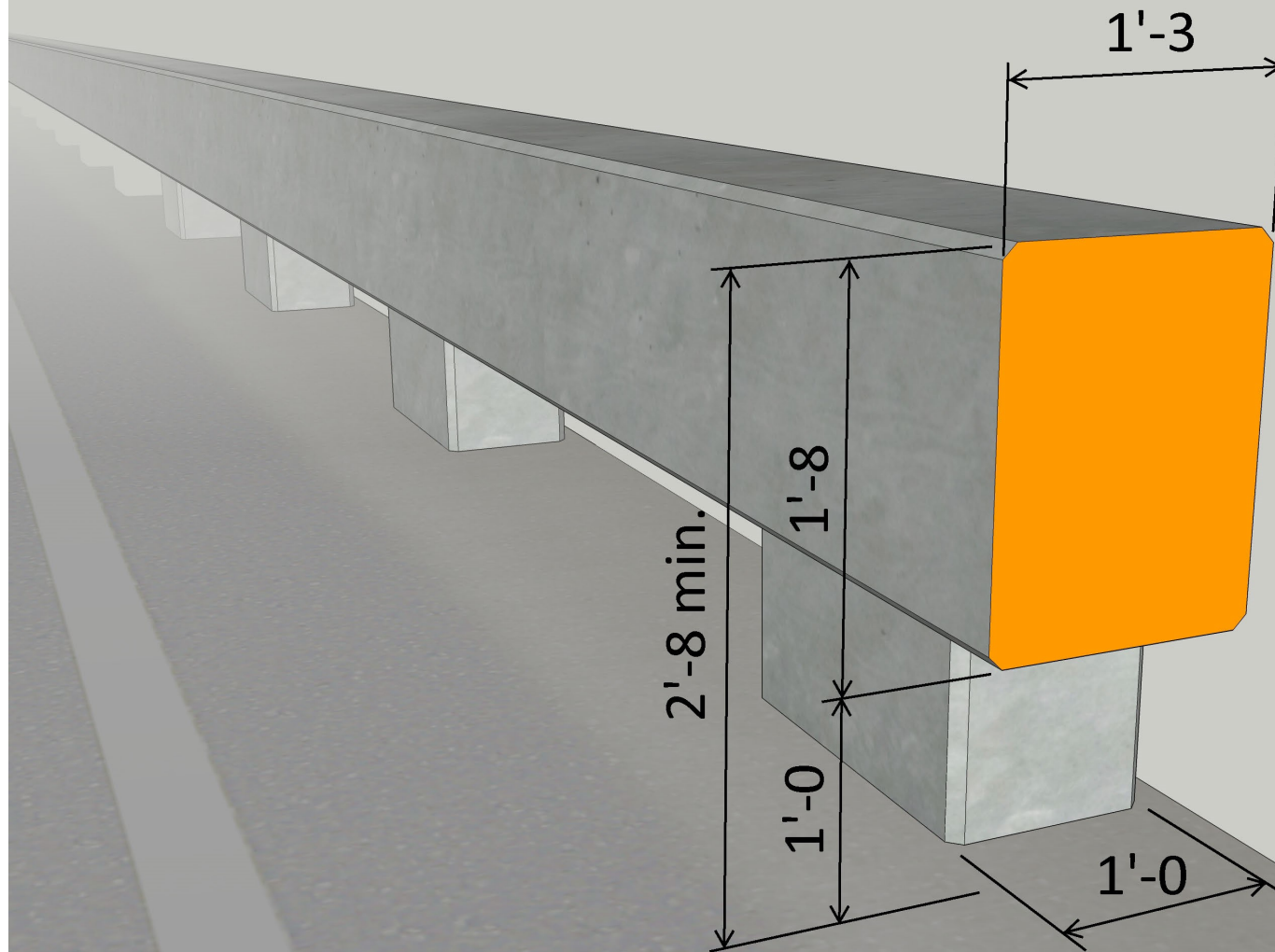

Note: 1'-0 x 2'-0 posts set back 2" from traffic face, spaced at 8'-0 c.-c. max.

### Iowa Concrete Beam and Post (2006+)

- NCHRP Report 230, PL-2 (equivalent to NCHRP Report 350 TL-4)
- Current MASH equivalency: unknown
- AASHTO B.RH.01 Code: 2302
- Notes: measured height must be 2'-8 min. at all points on bridge; note the dimensional differences to the pre-2006 beam and post; this rail was adopted from the Kansas Corral rail successfully tested to NCHRP 230 PL-2 in 1991
- Crash test reports: TRP-03-26-91 (Kansas Corral rail)
- W:\Highway\Bridge\MethodsSection\Barriers\Rail Guide\1\_1997 FHWA Memo Rails+NCHRP 350\Iowa Conc Beam and Post

## Section 2: Vertical Face and Open Concrete Rails

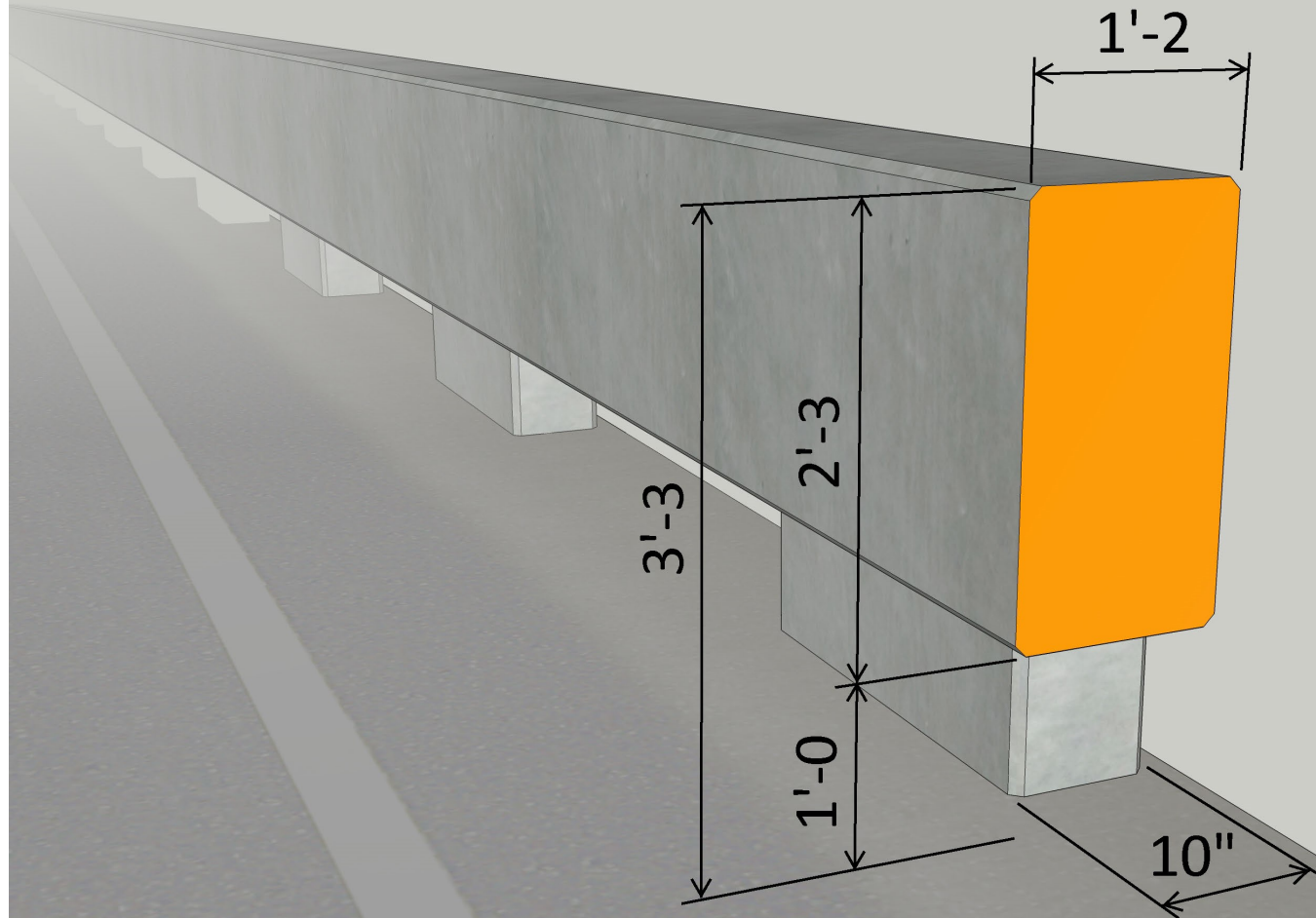

### Open Concrete Bridge Rail (OCBR) (MASH)

- MASH 2016 (TL-4)
- AASHTO B.RH.01 Code: M234
- Note: measured height must be 3'-0 min. at all points on bridge; note the dimensional differences to the pre-2006 and 2006 beam and post designs
- Crash test reports: TRP-03-406b-24
- W:\Highway\Bridge\MethodsSection\Barriers\Rail Guide\3\_MASH Era Rails\_ also see MASH\OCBR Beam and Post

Note: 10" x 3'-0 posts set back 4" from traffic face, spaced at 9'-0 c.-c. max.

## Section 2: Vertical Face and Open Concrete Rails

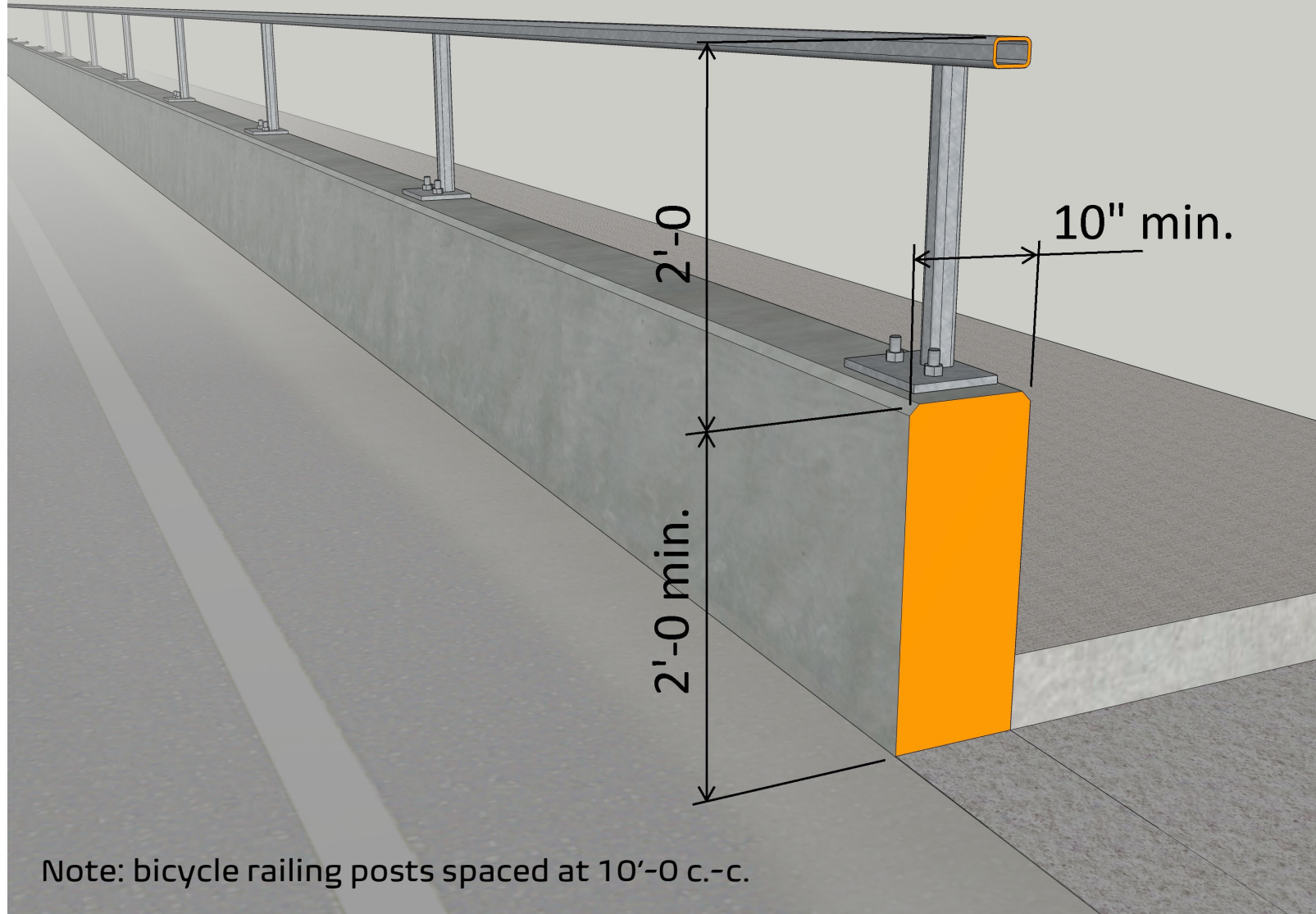

Note: bicycle railing posts spaced at 10'-0 c.-c.

### IBBR Separation Rail (MASH)

- MASH 2016, TL-2
- AASHTO B.RH.01 Code: M202
- Notes: measured height of concrete parapet must be 2'-0 min. at all points on bridge; for use as a separation barrier only; while the bicycle railing was crash tested as part of the complete rail system, it is not intended to redirect vehicle strikes so is not considered a Metal Tube Rail as shown in Section 1 of this guide; changes to the bicycle railing details are not allowed
- Crash test reports: TRP-03-408-20
- W:\Highway\Bridge\MethodsSection\Barriers\Rail Guide\3\_MASH Era Rails\_ also see MASH\IBBR Separation Rail

## Section 2: Vertical Face and Open Concrete Rails

Acceptable Variations:

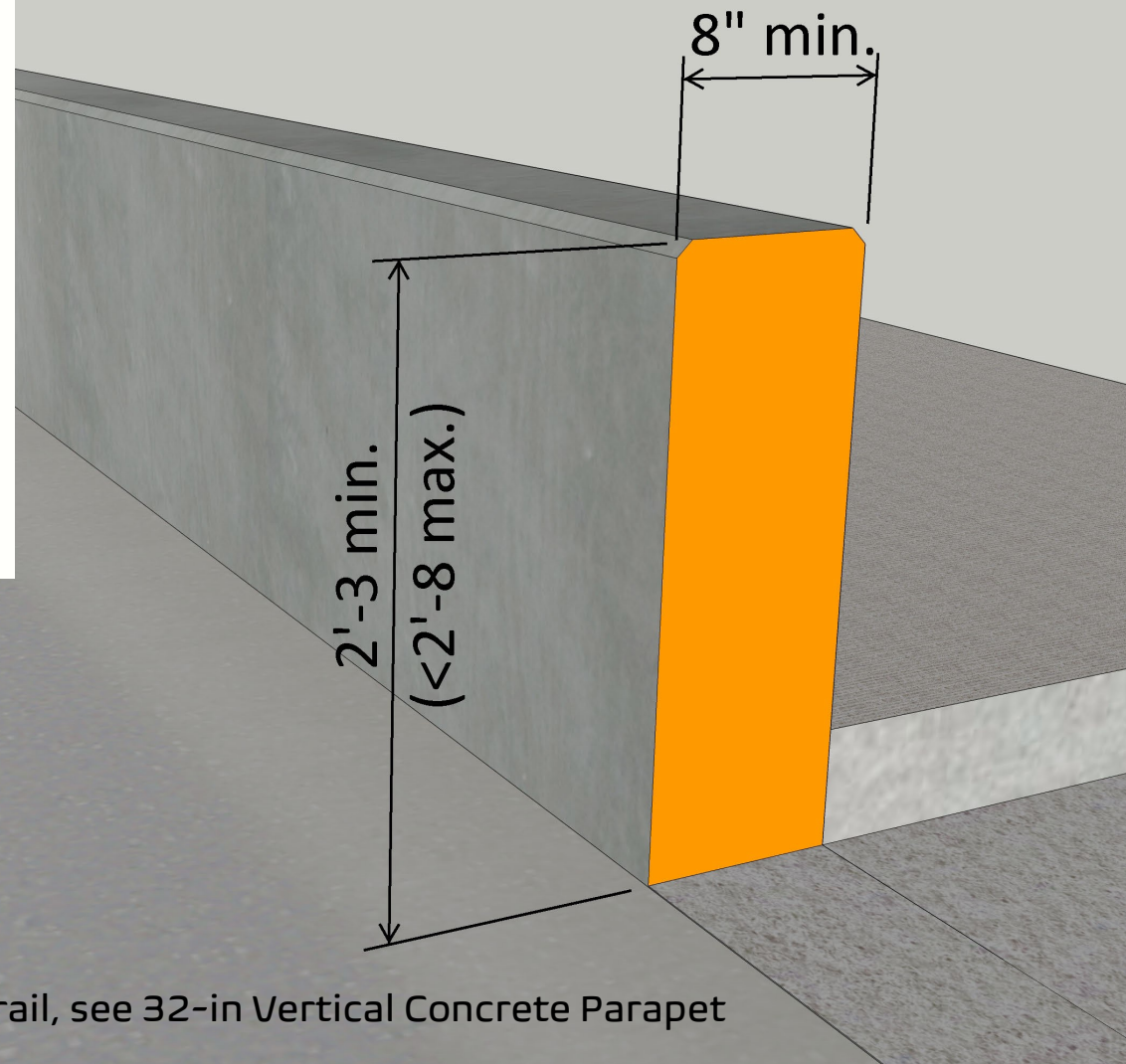

Note: for 2'-8 or taller rail, see 32-in Vertical Concrete Parapet

### Vertical 27-in Separation Rail

- 1989 Guide Specifications for Bridge Railings, PL-1 (equivalent to NCHRP Report 350 TL-2)
- Current MASH equivalency: unknown, but height and geometry are compliant for TL-2 (24-in min. vertical parapet height); design check required for strength
- AASHTO B.RH.01 Code: 891
- Notes: measured height must be 2'-3 min. at all points on bridge; for use as a separation barrier only, often with a bike rail attachment
- Crash test reports: unknown, but compliant with all historical AASHTO specifications for minimum vertical bridge parapet height
- W:\Highway\Bridge\MethodsSection\Barriers\Rail Guide\2\_Other Pre-MASH Rails Used by DOT\Vert 27 in Separator

# Section 2: Vertical Face and Open Concrete Rails

## Acceptable Variations:

Shallow traffic face rustication and texture are acceptable if within limits prescribed by Iowa DOT



Non-traffic-side treatments such as projections, rustication or texture have no effect on crash performance or B.RH.01 code

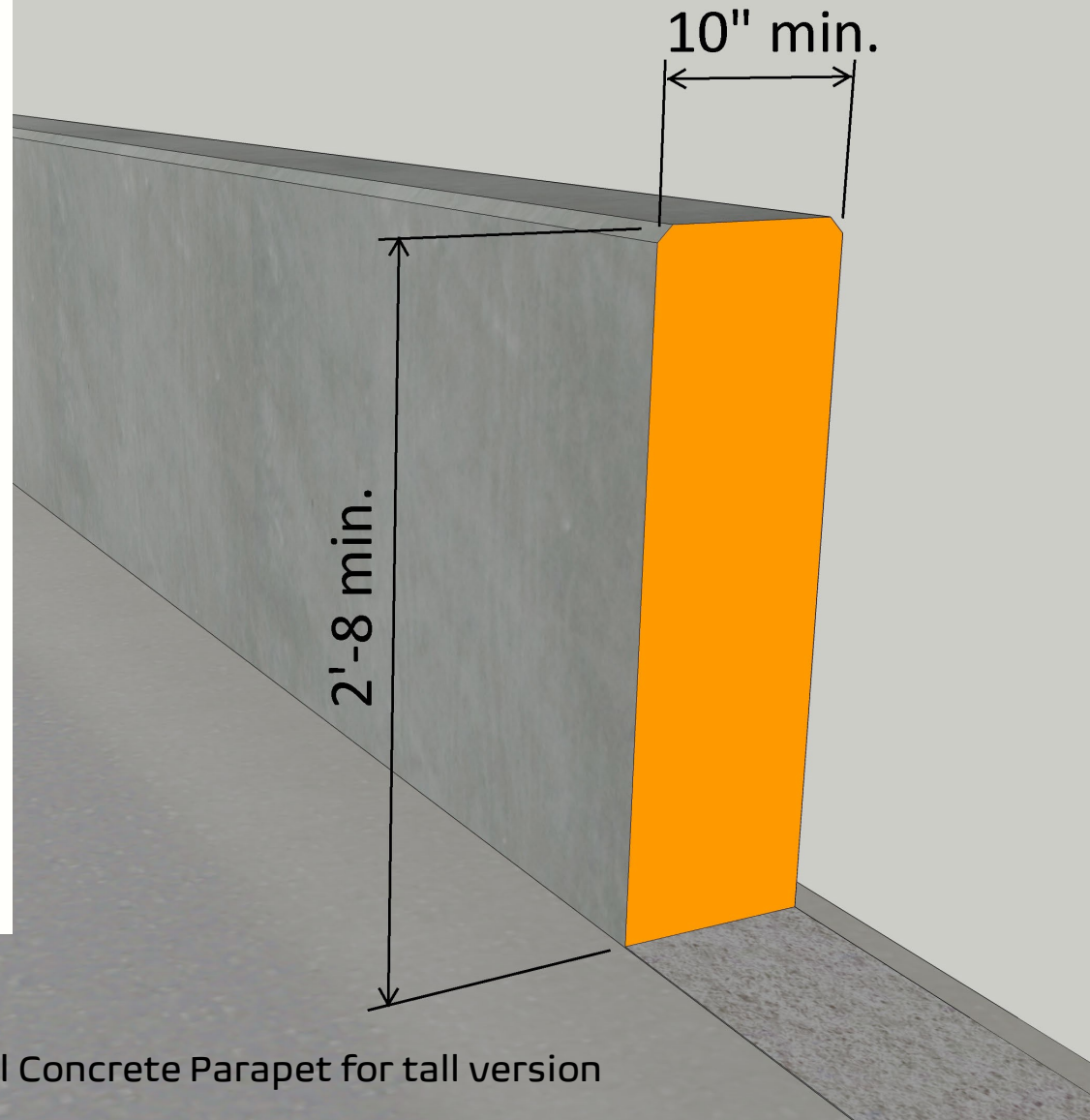
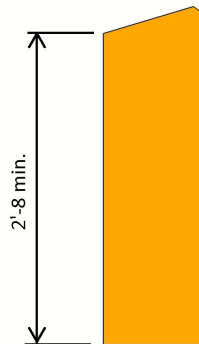

Note: see 42-in Vertical Concrete Parapet for tall version

## 32-in Vertical Concrete Parapet

- 1989 Guide Specifications for Bridge Railings, PL-2 (equivalent to NCHRP Report 350 TL-4; see 1997 FHWA Memo)
- Current MASH equivalency: TL-3 for height and geometry; design check required for strength
- AASHTO B.RH.01 Code: 892
- Notes: measured height must be 2'-8 min. at all points on bridge; often used as a separation barrier with a bike rail attachment (not crash tested); Iowa DOT's BMBR rail is an example of this rail, but it requires a 1'-0 min. parapet width when used with a back-mounted bicycle railing attachment
- Crash test reports: FHWA-RD-93-058, FHWA-RD-93-062
- W:\Highway\Bridge\MethodsSection\Barriers\Rail Guide\1\_1997 FHWA Memo Rails+NCHRP 350\32-in Vertical Parapet

## Section 2: Vertical Face and Open Concrete Rails

### Acceptable Variations:

Non-traffic-side treatments such as projections, rustication or texture have no effect on crash performance or B.RH.01 code

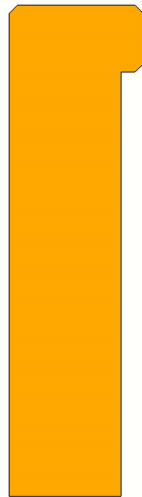

10" min.

3'-6 min.

## 42-in Vertical Concrete Parapet

- 1989 Guide Specifications for Bridge Railings, PL-3 (equivalent to NCHRP Report 350 TL-5; see 1997 FHWA Memo)
- Current MASH equivalency: TL-5 for height and geometry; design check required for strength
- AASHTO B.RH.01 Code: 893
- Note: measured height must be 3'-6 min. at all points on bridge
- Crash test reports: FHWA-RD-93-067
- W:\Highway\Bridge\MethodsSection\Barriers\Rail Guide\1\_1997 FHWA Memo Rails+NCHRP 350\42-in Vertical Parapet

Note: see 32-in Vertical Concrete Parapet for short version

# Section 2: Vertical Face and Open Concrete Rails

## Acceptable Variations:

Top-mounted pedestrian railing allowed only with approval

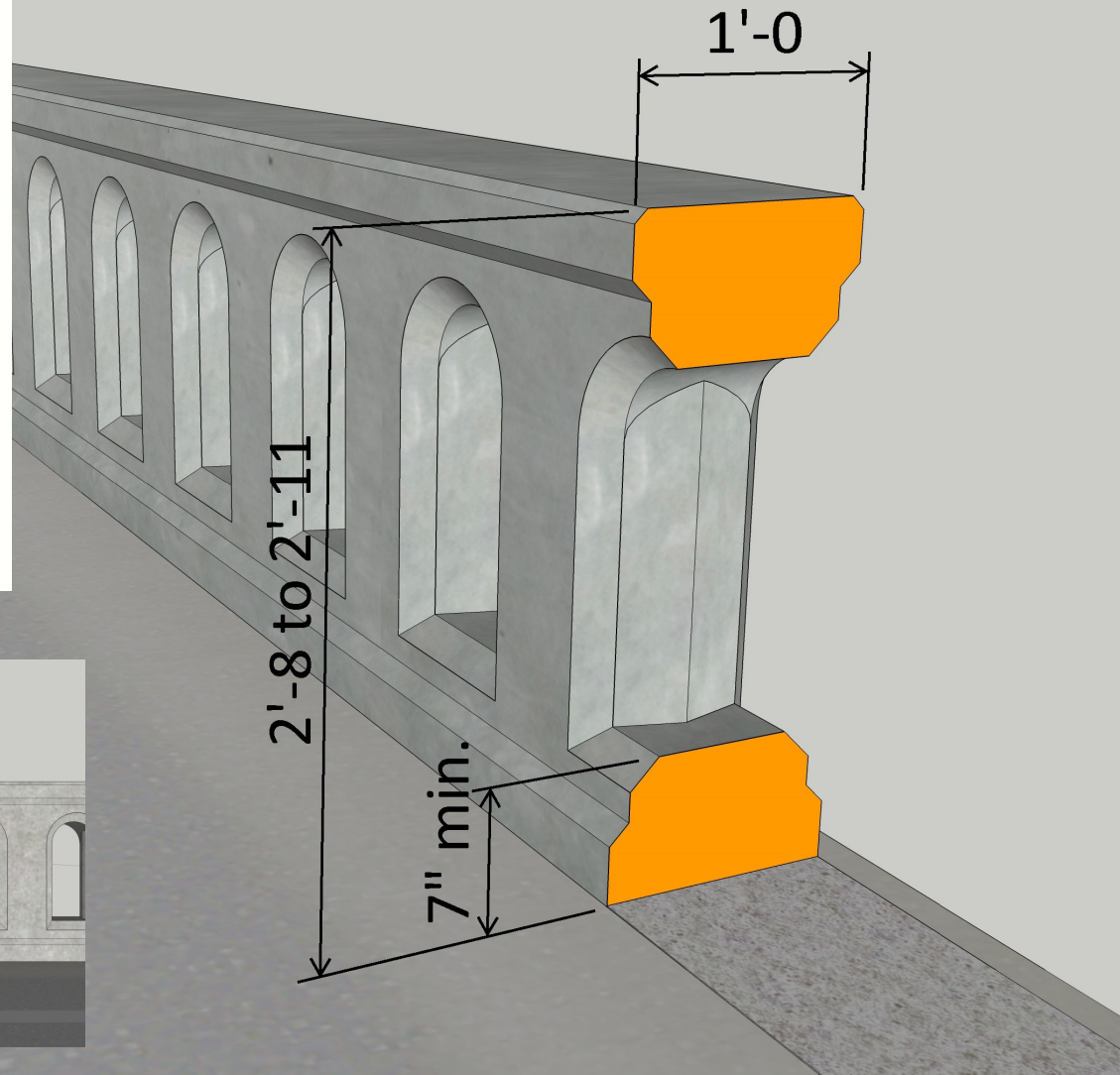
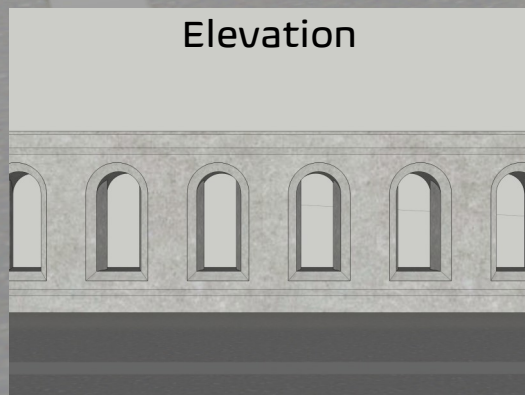
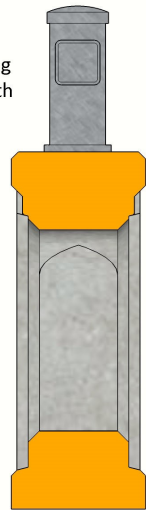

## Texas T411 Aesthetic Concrete Baluster

- NCHRP Report 350, TL-2
- Current MASH equivalency: TL-2 for height and geometry; design check required for strength; see updated MASH TL-2 version for future project applications
- AASHTO B.RH.01 Code: 3502
- Notes: measured height must be 2'-8 min. at all points on bridge; can be used as a separation barrier under certain conditions; consult the BDM for guidance; top-mounted pedestrian railing attachments are allowed only in low speed conditions and with Iowa DOT approval; Texas C411 42-in version is also acceptable for use with similar restrictions to those listed in BDM for T411
- Crash test reports: FHWA/TX-98/1804-3
- W:\Highway\Bridge\MethodsSection\Barriers\Rail Guide\1\_1997 FHWA Memo Rails+NCHRP 350\TX T411 Aesth Baluster

## Section 2: Vertical Face and Open Concrete Rails

### Texas F411

- NCHRP Report 350, TL-4
- Current MASH equivalency: TL-4 based on stability/height and geometry, but not strength; see updated MASH version for TL-4/TL-5 under name "C412"
- AASHTO B.RH.01 Code: 3504
- Note: measured height must be 3'-6 min. at all points on bridge
- Crash test reports: FHWA/TX-03/4288-1, FHWA/TX-05/9-8132-P7
- Example locations: US 20 & Southwest Arterial Interchange, Dubuque Co. Designs 116, 717, 817
- W:\Highway\Bridge\MethodsSection\Barriers\Rail Guide\2\_Other Pre-MASH Rails Used by DOT\Texas F411

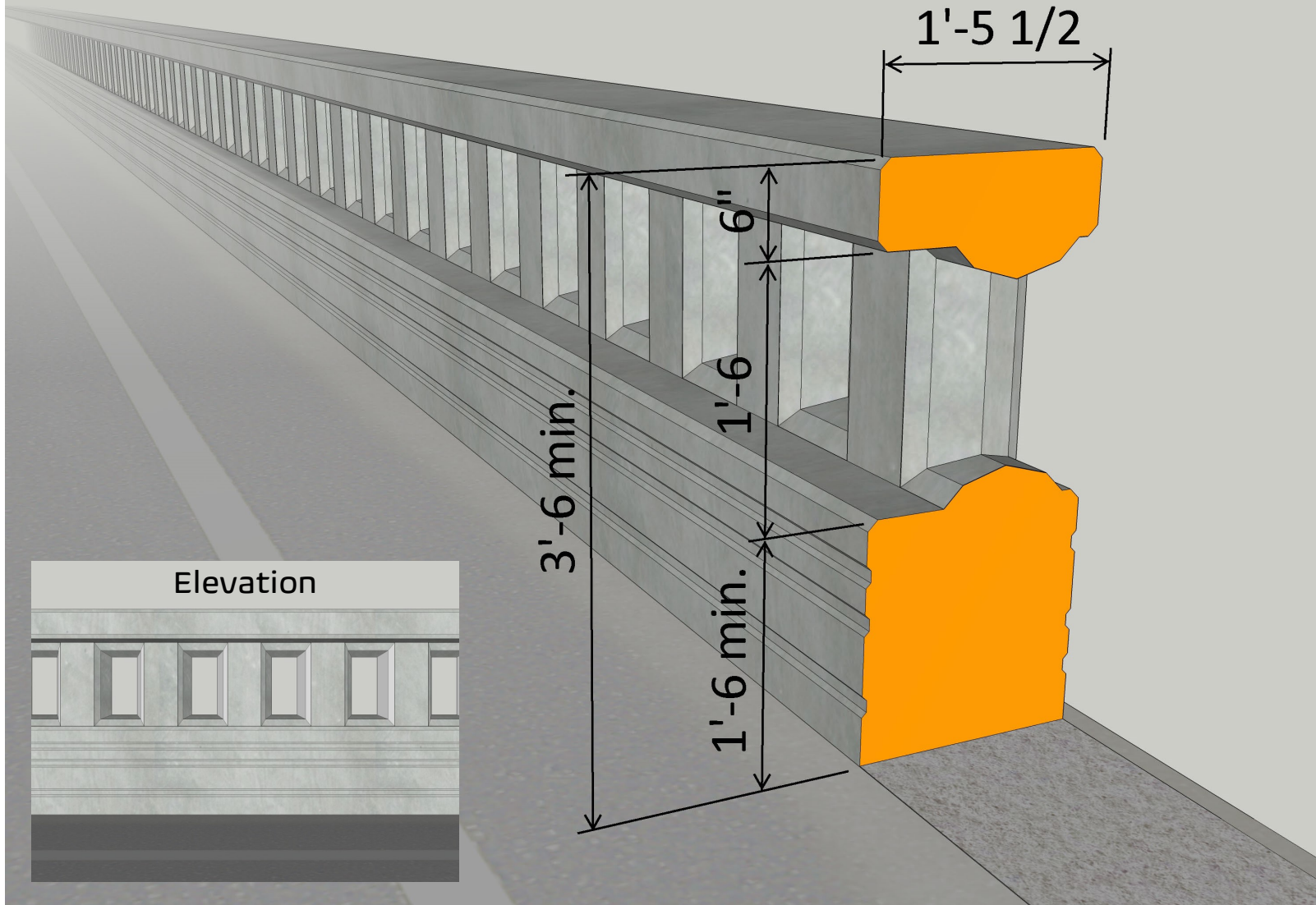



## Section 2: Vertical Face and Open Concrete Rails

### Aesthetic Precast Concrete Rail (US 30 Clinton)

- Test spec: not tested
- Rail geometry is compliant with AASHTO Specifications for Highway Bridges 2.7.1 Vehicular Railings; may be fully compliant with a successful structural check against Section 2.7.1.3; see MwRSF comments on crashworthiness concerns due to some rail features (waved top, traffic face rustication, light pole pedestals, attachments)
- Current MASH equivalency: unknown
- AASHTO B.RH.01 Code: S99
- Example locations: in service on just 2 bridges carrying US 30 in Clinton, IA
- W:\Highway\Bridge\MethodsSection\Barriers\Rail Guide\2\_Other Pre-MASH Rails Used by DOT\Aesth Conc US 30 Clinton

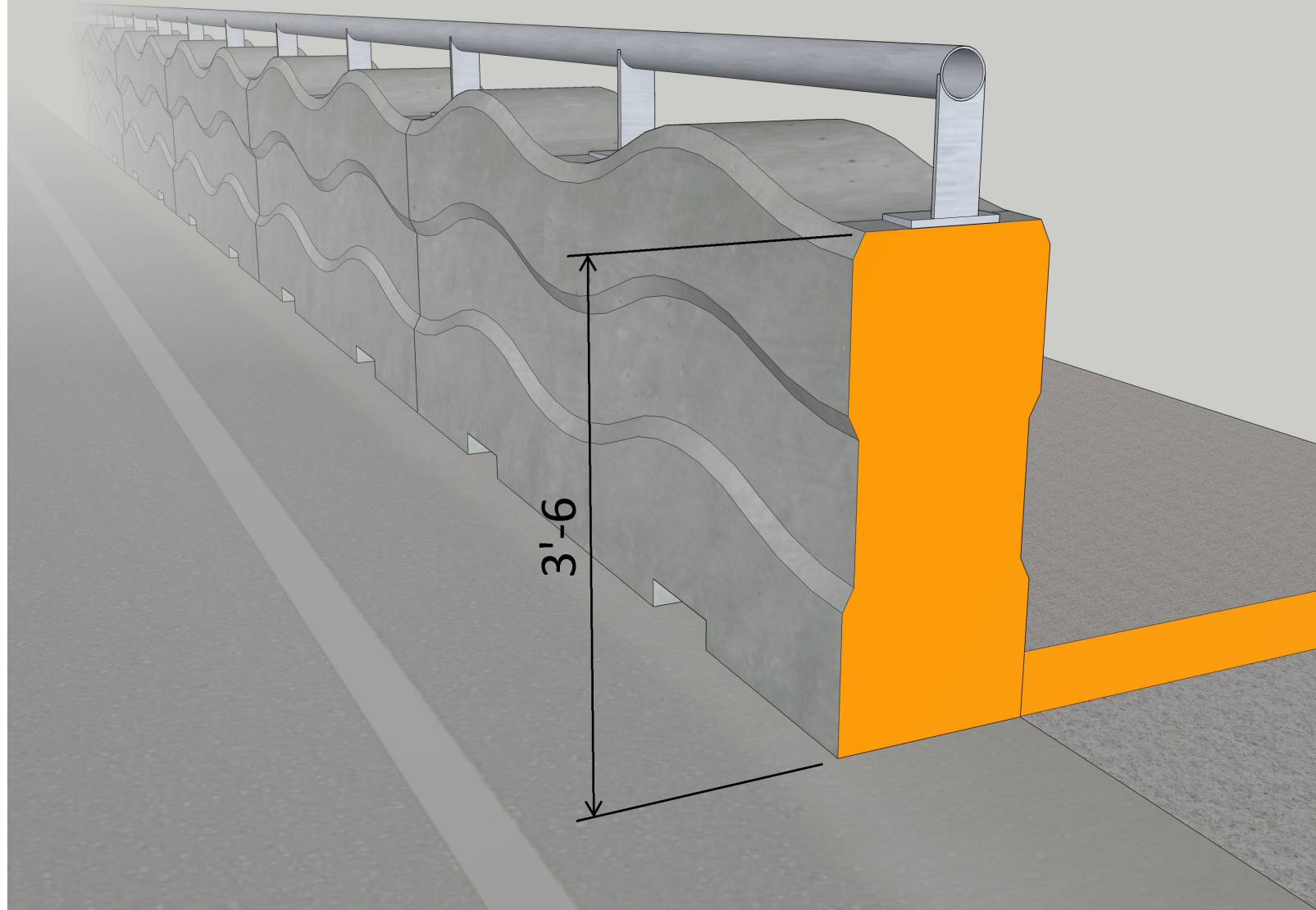

## Section 2: Vertical Face and Open Concrete Rails

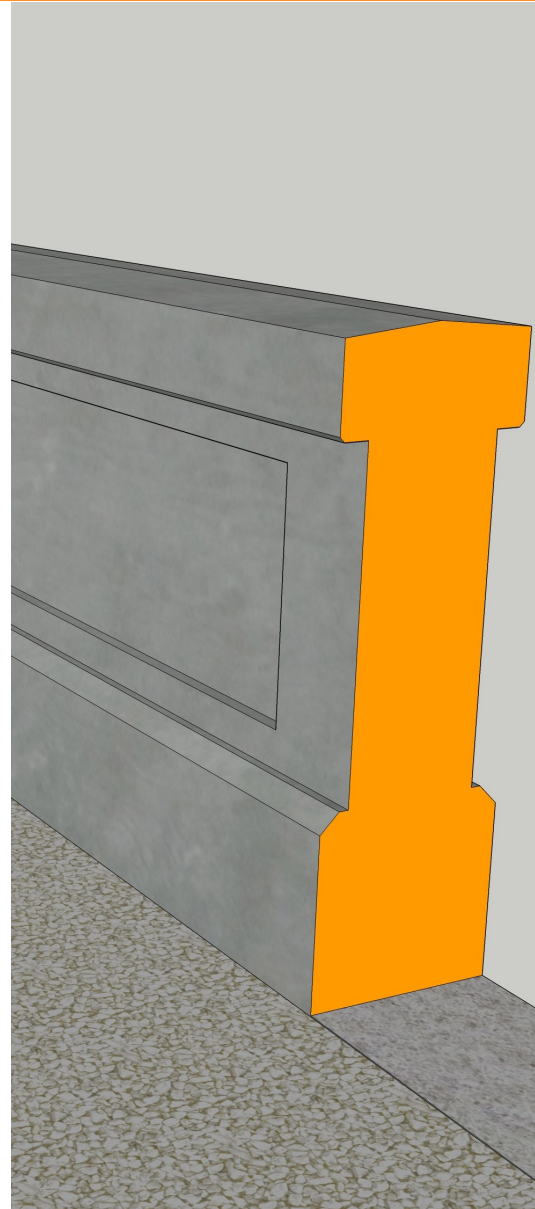
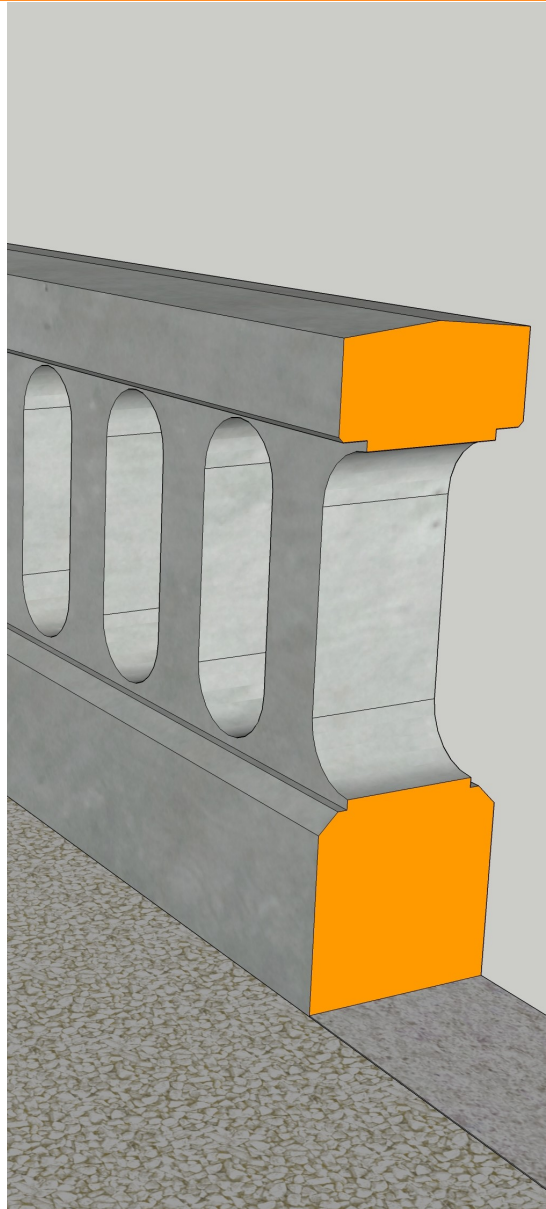
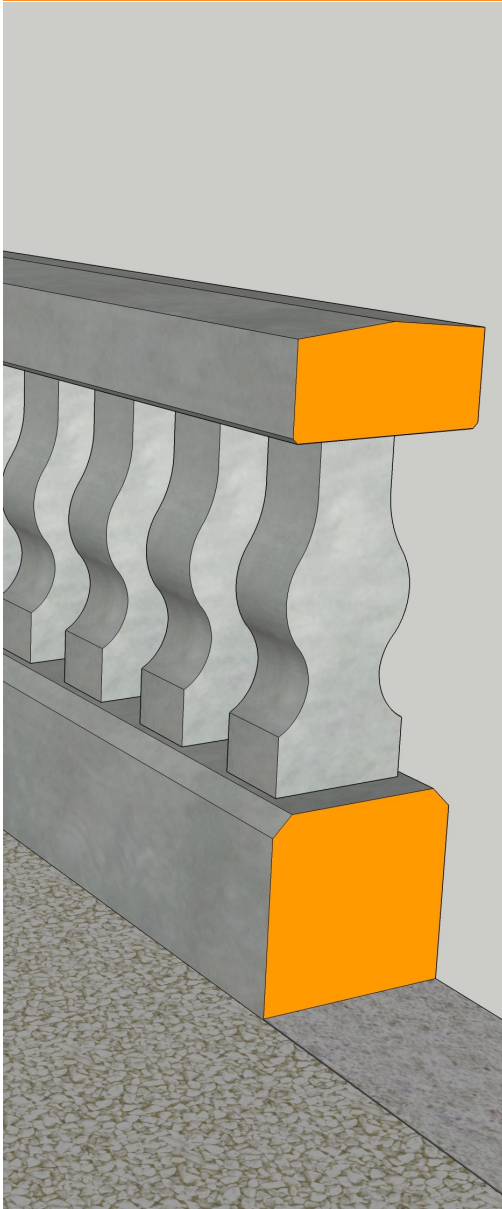

### Early 1900s Concrete Rails

- Test spec: not tested
- Rail geometry may be compliant with AASHTO Specifications for Highway Bridges 2.7.1 Vehicular Railings with a successful structural check against Section 2.7.1.3
- Current MASH equivalency: unknown
- AASHTO B.RH.01 Code: S00
- Note: these rail types are most commonly found on county and local (often unpaved) roads; typically found on short span slab bridges or culverts
- Example locations:
- W:\Highway\Bridge\MethodsSection\Barriers\Rail Guide\4\_Pre-MASH Rails used in IA by others\Early 1900s Concrete

# Section 3: Safety Shape and Single Slope Concrete Rails

## Acceptable Variations:

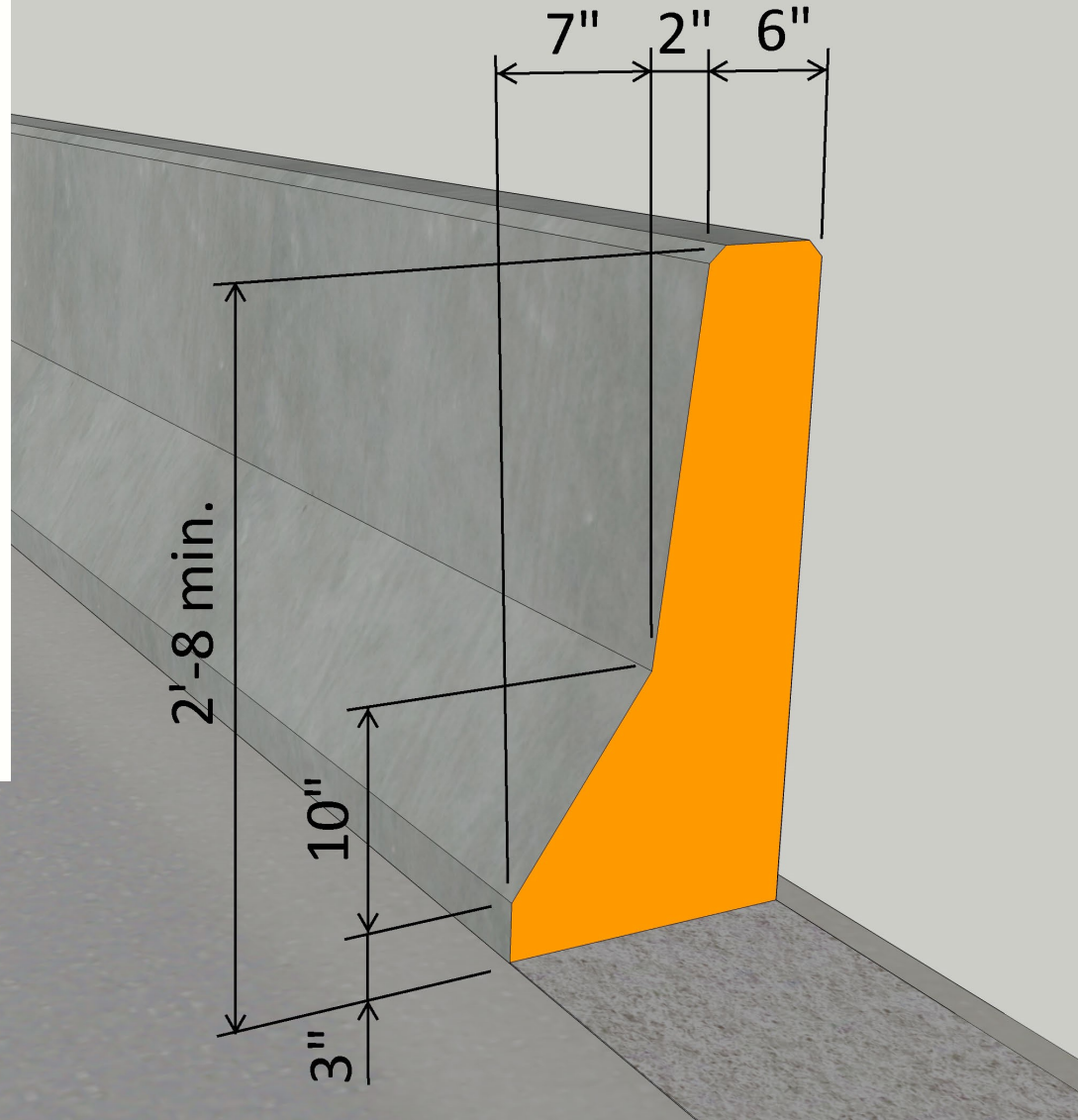
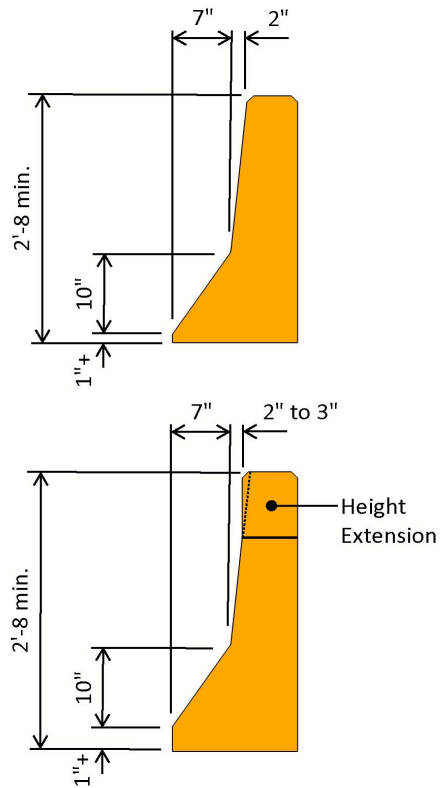

## New Jersey Safety Shape

- NCHRP Report 230, TL-4 (equivalent to NCHRP 350 TL-4\*; see 1997 FHWA Memo)
- Current MASH equivalency: TL-3 for height and geometry (proven through testing); design check required for strength
- AASHTO B.RH.01 Code: 2304
- Note: measured height must be 2'-8 min. at all points on bridge; note the dimensional differences in the traffic face compared to the F-Shape
- Crash test reports: FHWA-RD-93-058, TRP-03-177-06, TRP-03-178-06, NCHRP Project 22-14(3)/Web-Only Document 157 (\*failed 2019 re-test of 32-in NJ Safety Shape to NCHRP 350 TL-4 with a single unit truck)
- W:\Highway\Bridge\MethodsSection\Barriers\Rail Guide\1\_1997 FHWA Memo Rails+NCHRP 350\TL-4 NJ Safety Shape Rail

# Section 3: Safety Shape and Single Slope Concrete Rails

Acceptable Variations:

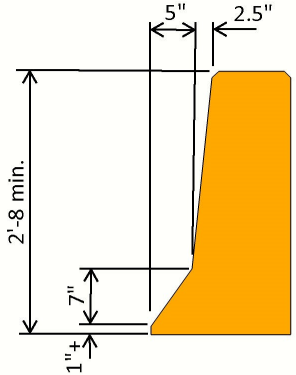

Non-traffic-side treatments such as projections, rustication or texture have no effect on crash performance or B.RH.01 code

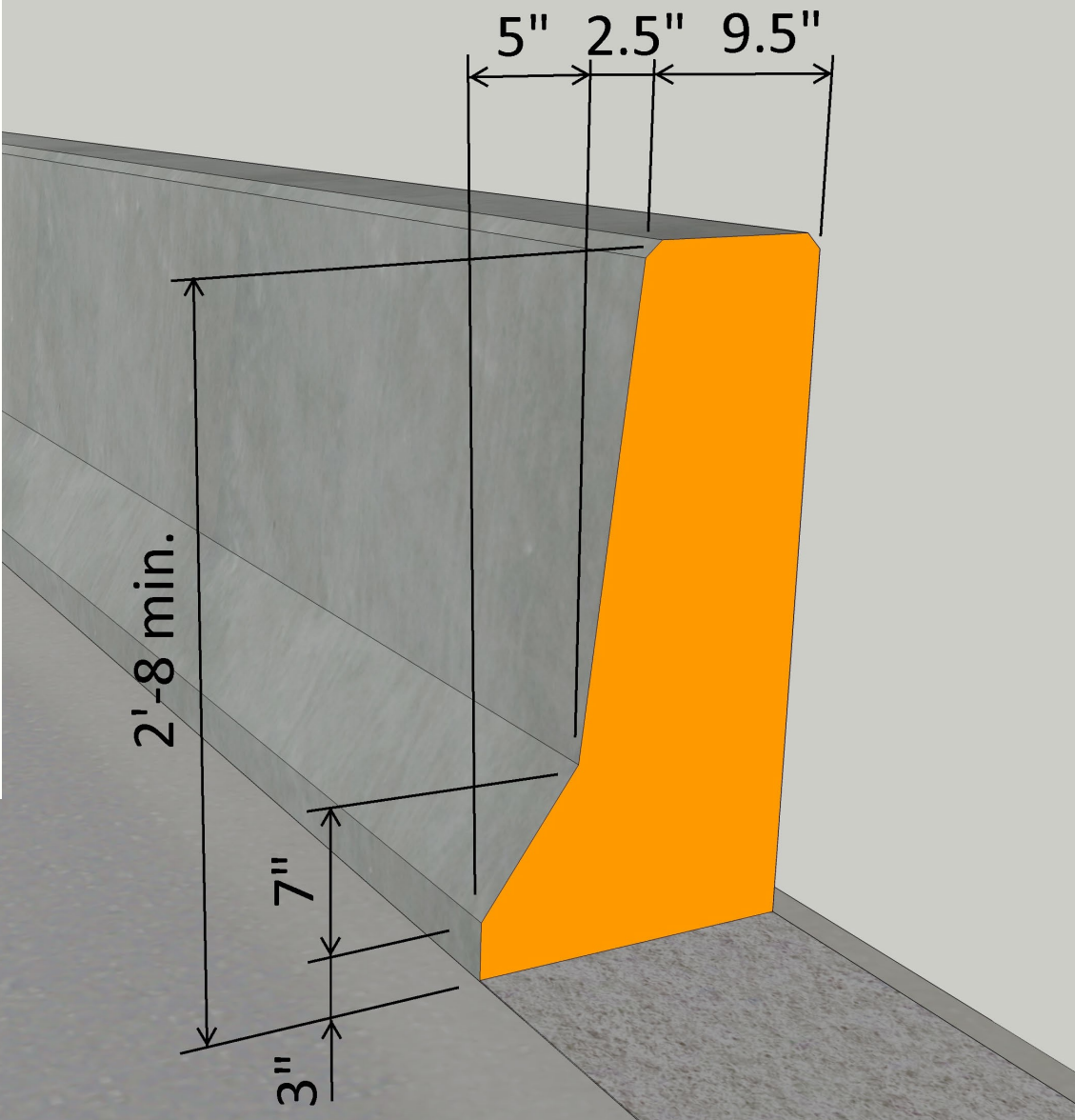
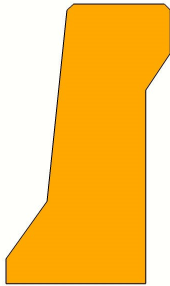

## TL-4 F-Shape Concrete

- NCHRP Report 350, TL-4 (see 1997 FHWA Memo)
- Current MASH equivalency: TL-3 for height and geometry; design check required for strength
- AASHTO B.RH.01 Code: 3504
- Notes: measured height must be 2'-8 min. at all points on bridge; note the dimensional differences in the traffic face compared to the New Jersey Safety Shape; barrier attachments such as bicycle railing, chain link fence, or noise wall may indicate a different effective Test Level. See other devices in this guide for the appropriate documentation associated with these attachments.
- Crash test reports: FHWA-RD-93-058
- W:\Highway\Bridge\MethodsSection\Barriers\Rail Guide\1\_1997 FHWA Memo Rails+NCHRP 350\TL-4 F-Shape Rail

# Section 3: Safety Shape and Single Slope Concrete Rails

Acceptable Variations:

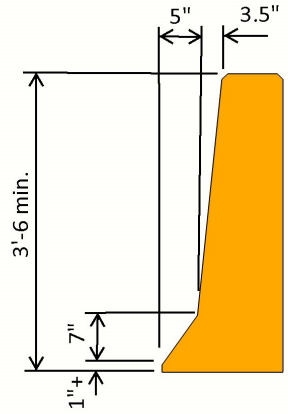

Non-traffic-side treatments such as projections, rustication or texture have no effect on crash performance or B.RH.01 code

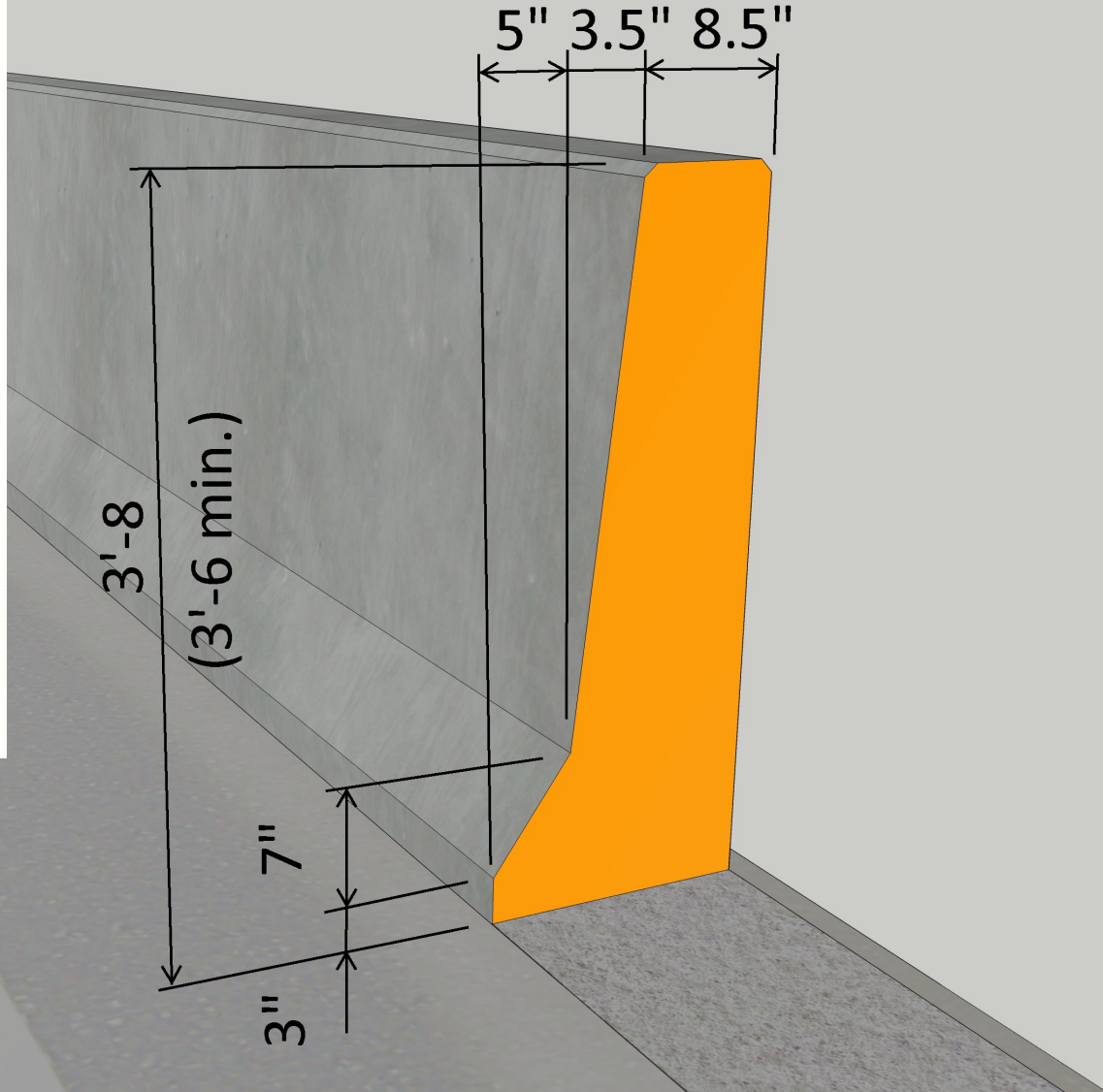
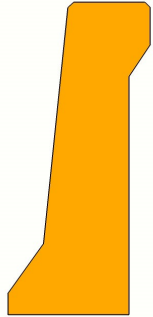

## TL-5 F-Shape Concrete

- 1989 Guide Specifications for Bridge Railings, PL-3 (equivalent to NCHRP Report 350 TL-5; see 1997 FHWA Memo)
- Current MASH equivalency: TL-5 for height and geometry; design check required for strength
- AASHTO B.RH.01 Code: 893
- Notes: measured height must be 3'-6 min. at all points on bridge; barrier attachments may indicate a different effective Test Level. See other devices in this guide for the appropriate documentation associated with these attachments.
- Crash test reports: FHWA-RD-93-058, FHWA-RD-93-068
- W:\Highway\Bridge\MethodsSection\Barriers\Rail Guide\1\_1997 FHWA Memo Rails+NCHRP 350\TL-5 F-Shape Rail

# Section 3: Safety Shape and Single Slope Concrete Rails

## Low Profile 22-in Separation Rail

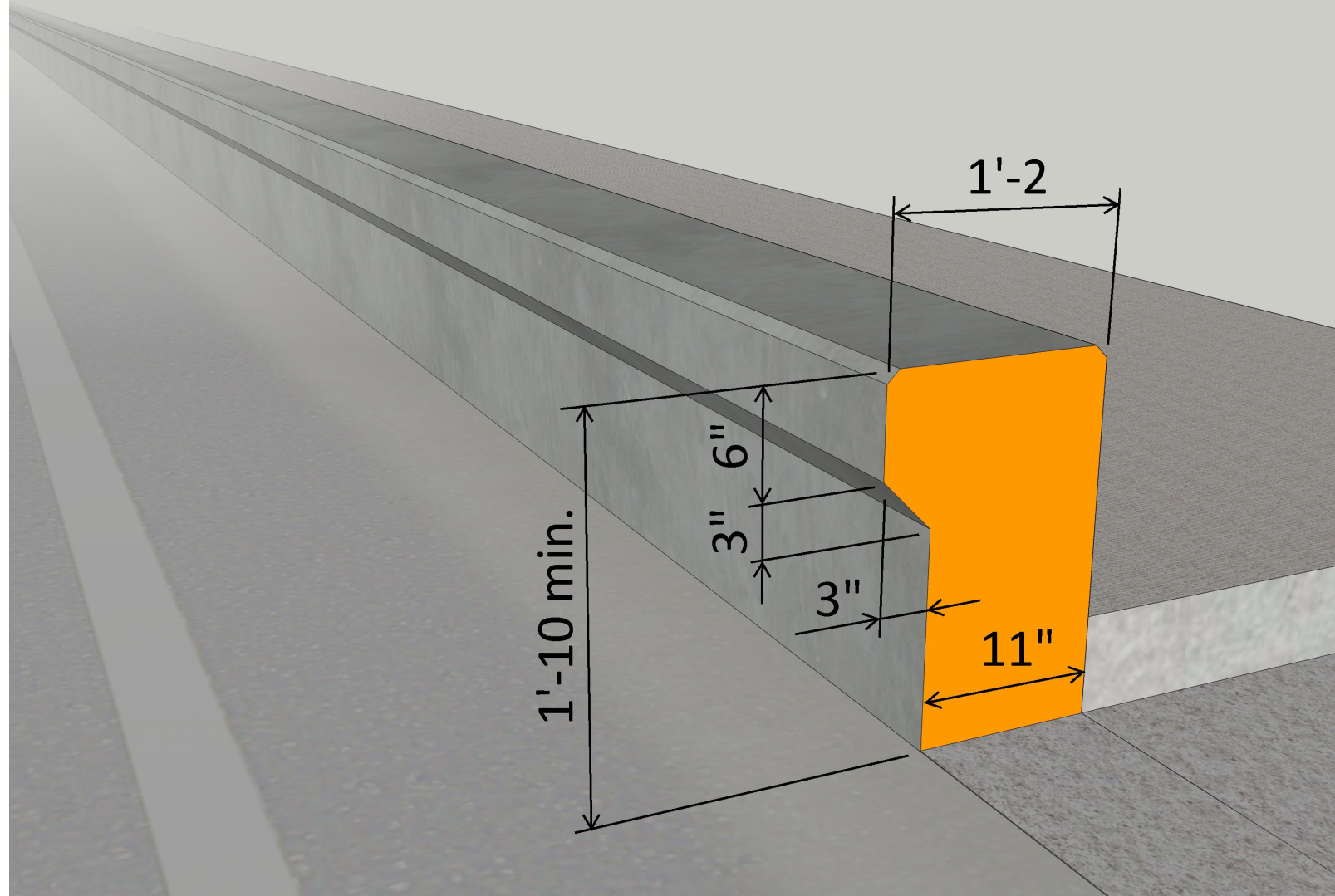

- NCHRP Report 350 TL-2
- Current MASH equivalency: unknown, but MASH test of a short (18") vertical face TBR by FL suggests possible TL-2 equivalency
- AASHTO B.RH.01 Code: 3502
- Notes: measured height must be 1'-10 min. at all points on bridge; for use as a separation barrier only, 30 MPH max. posted speed, and requires a Design Exception process due to non-compliant height on sidewalk side (24-in min. per AASHTO)
- Crash test reports: TRP-03-109-02
- Example location: 9th Street over I-235, Des Moines, Polk Co. Design No. 2406
- W:\Highway\Bridge\MethodsSection\Barriers\Rail Guide\1\_1997 FHWA Memo Rails+NCHRP 350\Low Profile 22-in Separator

# Section 3: Safety Shape and Single Slope Concrete Rails

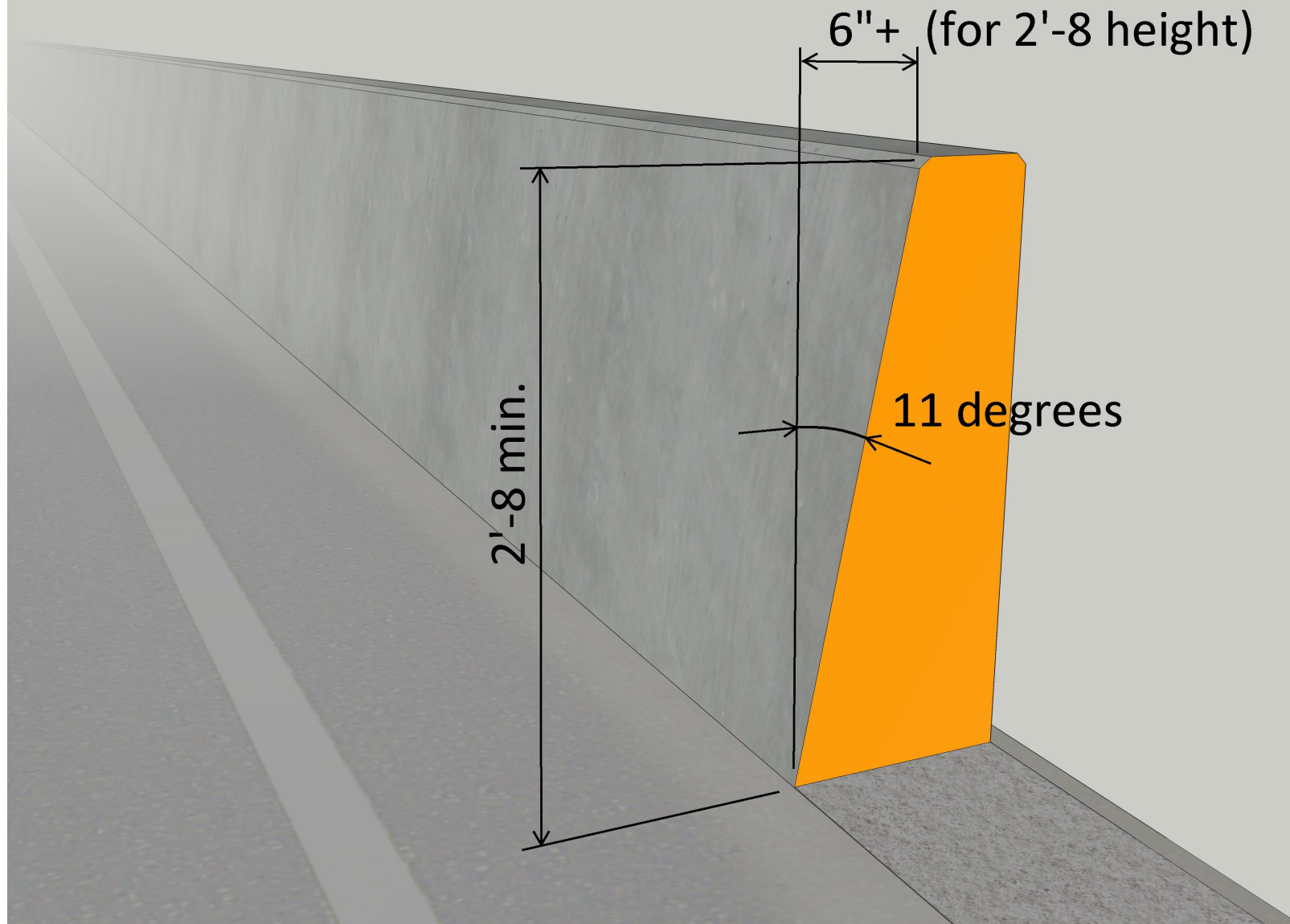

## Single Slope Concrete 11 Degrees (Pre-MASH)

- 1989 Guide Specifications for Bridge Railings, PL-2 (equivalent to NCHRP Report 350 TL-4; see 1997 FHWA Memo)
- Current MASH equivalency: TL-4 for height and geometry; design check required for strength
- AASHTO B.RH.01 Code: 892
- Notes: measured height must be 2'-8 min. at all points on bridge; for 3'-2 and taller single slope rails, see 38-in Single Slope TL-4 Rail and 44-in Single Slope TL-5 Rail
- Crash test reports: FHWA-RD-98-43
- Example location: US 6 Broadway Viaduct in Council Bluffs, Pott. Co. Design 210
- W:\Highway\Bridge\MethodsSection\Barriers\Rail Guide\1\_1997 FHWA Memo Rails+NCHRP 350\Single Slope Conc 11 degrees

# Section 3: Safety Shape and Single Slope Concrete Rails

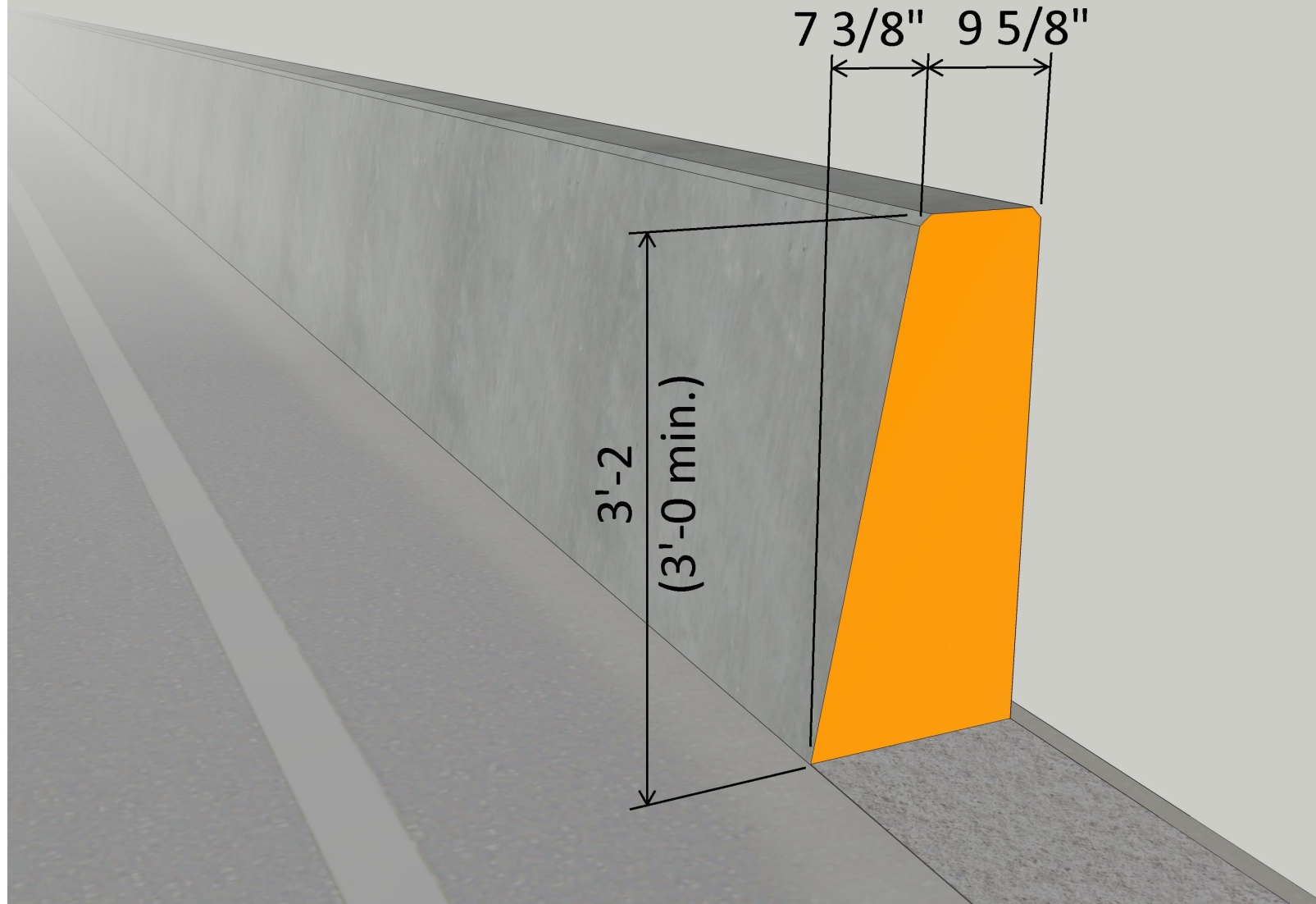

## 38-in Single Slope TL-4 Rail (MASH)

- MASH 2009, TL-4
- See also Methods MASH folder of barriers approved for Iowa
- AASHTO B.RH.01 Code: M114
- Note: measured height must be 3'-0 min. at all points on bridge
- Crash test reports: FHWA/TX-12/9-1002-5
- W:\Highway\Bridge\MethodsSection\Barriers\Rail Guide\3\_MASH Era Rails\_ also see MASH\38-in Single Slope Rail\_TSS TL-4



# Section 3: Safety Shape and Single Slope Concrete Rails

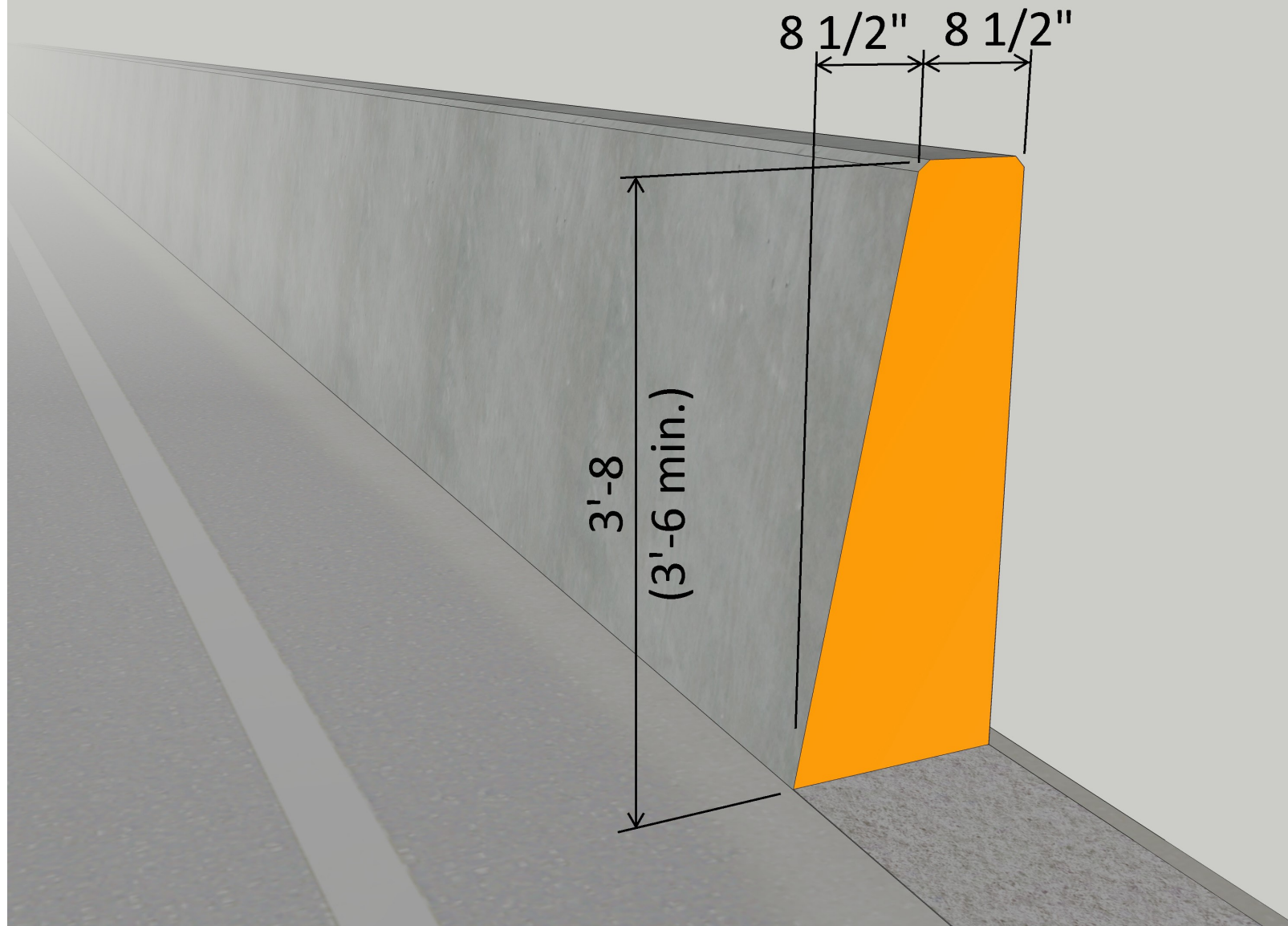

## 44-in Single Slope TL-5 Rail

- NCHRP Report 350, TL-5
- Current MASH equivalency: TL-5
- See also Methods MASH folder of barriers approved for Iowa
- AASHTO B.RH.01 Code: 3505
- Note: measured height must be 3'-6 min. at all points on bridge
- Crash test reports: 9429C-1 (TTI)
- W:\Highway\Bridge\MethodsSection\Barriers\Rail Guide\3\_MASH Era Rails\_ also see MASH\44-in Single Slope Rail\_TSS TL-5

# Section 3: Safety Shape and Single Slope Concrete Rails

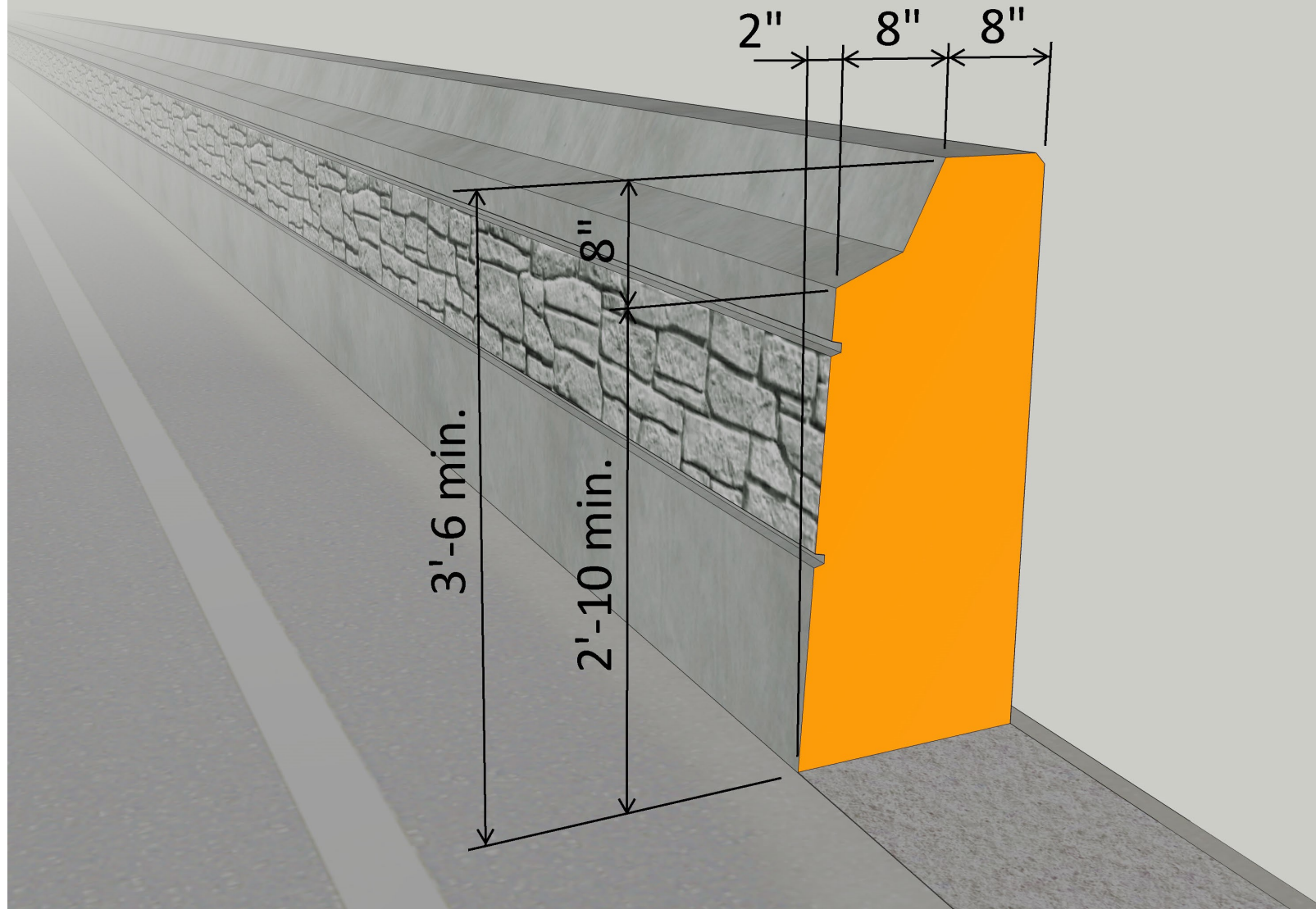

## Single Slope with Setback Top

- NCHRP Report 350, TL-5
- Current MASH equivalency: TL-5 for height and geometry; rail was given acceptance to pending MASH requirements in 2008; see FHWA letter HSSD/B-182; design check may be required for strength
- AASHTO B.RH.01 Code: 3505
- Notes: measured height must be 3'-6 min. at all points on bridge; shallow texture allowed with DOT approval (example shown was slip-formed using special equipment)
- Crash test reports: TRP-03-194-07
- Example locations: I-80 median bridge rails through Coralville and Iowa City, I-80/I-380 interchange median bridge rails
- W:\Highway\Bridge\MethodsSection\Barriers\Rail Guide\2\_Other Pre-MASH Rails Used by DOT\Single Slope w Setback Top

# Section 3: Safety Shape and Single Slope Concrete Rails

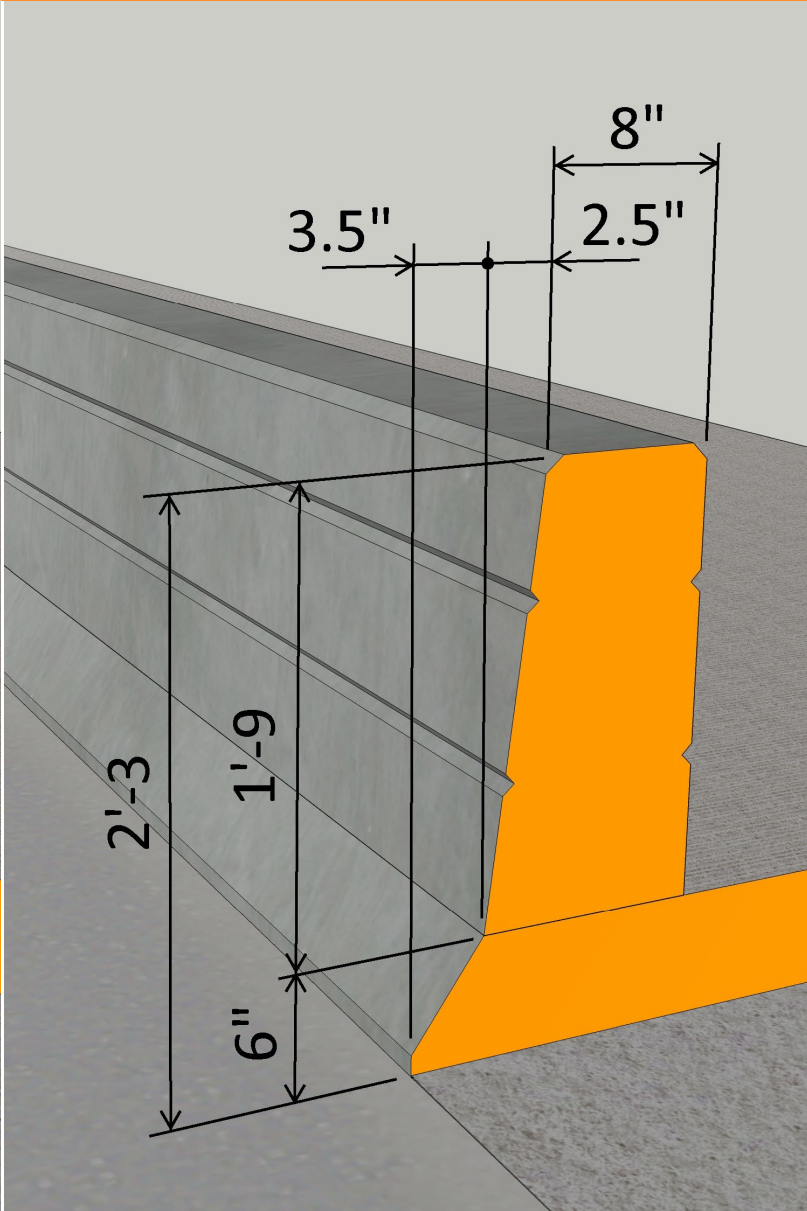
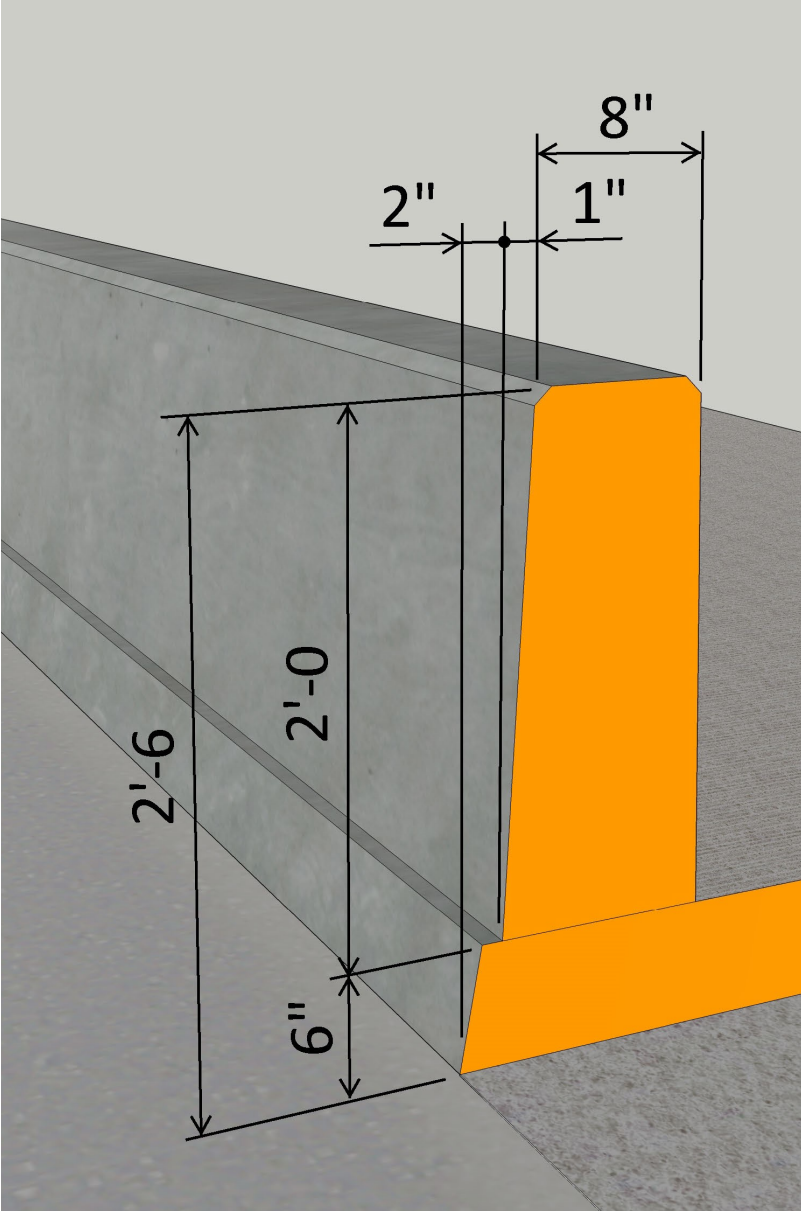

## Sloped Face Rails Under 32 in

- Test Specification: unknown/not tested
- Rail is not compliant with AASHTO Specifications for Highway Bridges 2.7.1 Vehicular Railings (insufficient sloped face barrier min. height)
- AASHTO B.RH.01 Code: S68
- Note: historical usage was as a separation rail mounted to a curb or raised sidewalk
- Example locations: Pocahontas County Design 268, Emmett County Design 173, Des Moines County Design 975
- W:\Highway\Bridge\MethodsSection\Barriers\Rail Guide\2\_Other Pre-MASH Rails Used by DOT\Sloped Face Rails Under 32 in

# Section 3: Safety Shape and Single Slope Concrete Rails

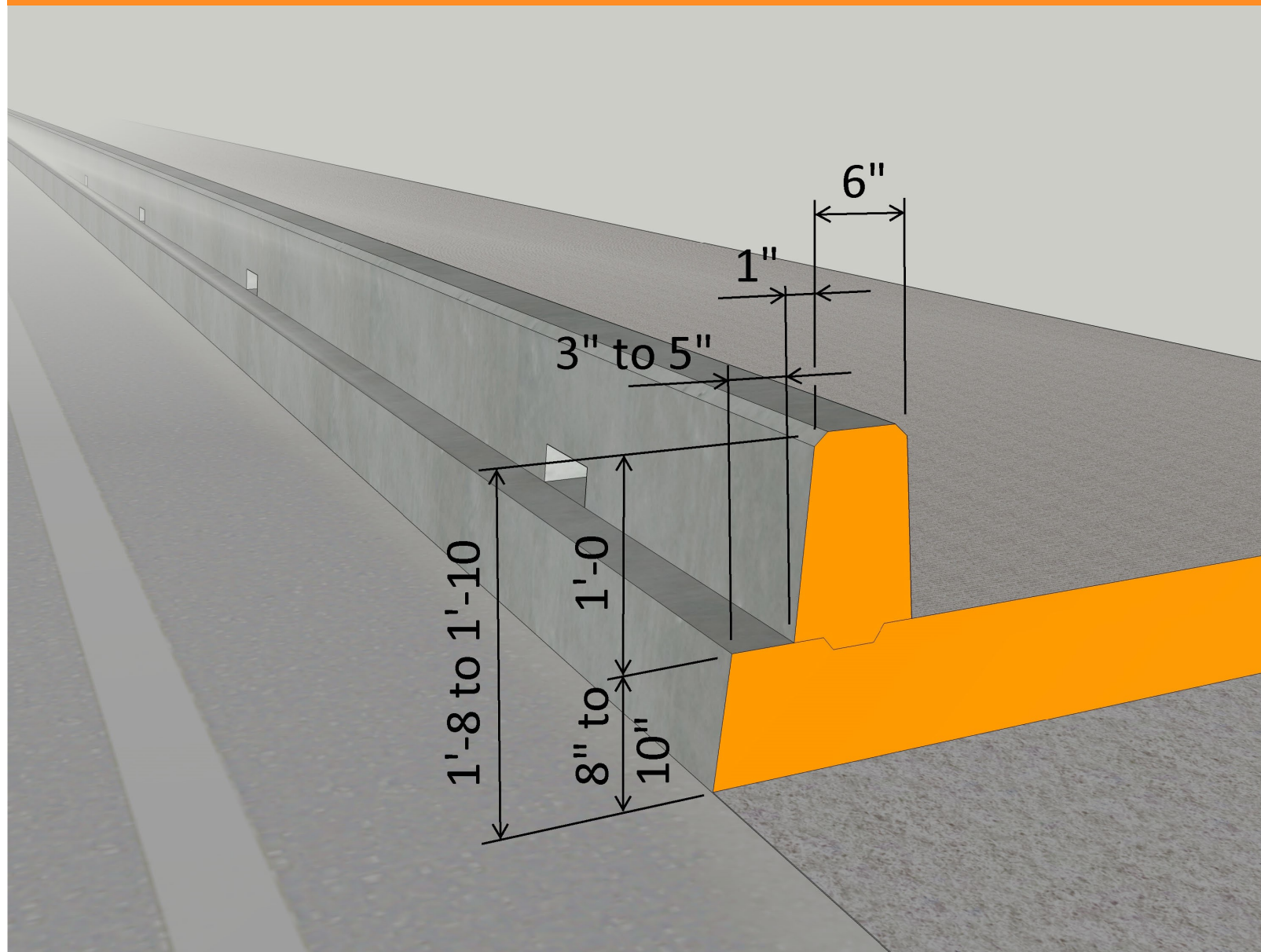

## Short Sloped Parapet on Curb

- Test Specification: unknown/not tested
- Rail is not compliant with AASHTO Specifications for Highway Bridges 2.7.1 Vehicular Railings (insufficient overall and parapet height, insufficient sloped face barrier min. height, and noncompliant with 1" max. vertical misalignment between rails on traffic face)
- AASHTO B.RH.01 Code: S48
- Note: historical usage was as a separation rail mounted to a curb or raised sidewalk
- Example location: IA 48 over Red Oak CR in Red Oak, orig. Des. No. 1148
- W:\Highway\Bridge\MethodsSection\Barriers\Rail Guide\2\_Other Pre-MASH Rails Used by DOT\Short Conc Parapet on Curb

## Section 4: Timber Rails

### Timber Rail Type 1

- Test Specification: unknown/not tested
- Rail is not compliant with AASHTO Specifications for Highway Bridges 2.7.1 Vehicular Railings (insufficient overall height); strength unknown
- AASHTO B.RH.01 Code: I
- Notes: rail was assessed by MwRSF against 1993 research performed on various timber rail curb shapes for low speed (15 MPH) and low impact angle (15 degrees) and was considered unsuitable for those impact characteristics; see TRP-03-31-93 for more information
- Example location: Backbone S.P., Delaware County Design 233 (original rail)
- W:\Highway\Bridge\MethodsSection\Barriers\Rail Guide\2\_Other Pre-MASH Rails Used by DOT\Timber Rails—Various

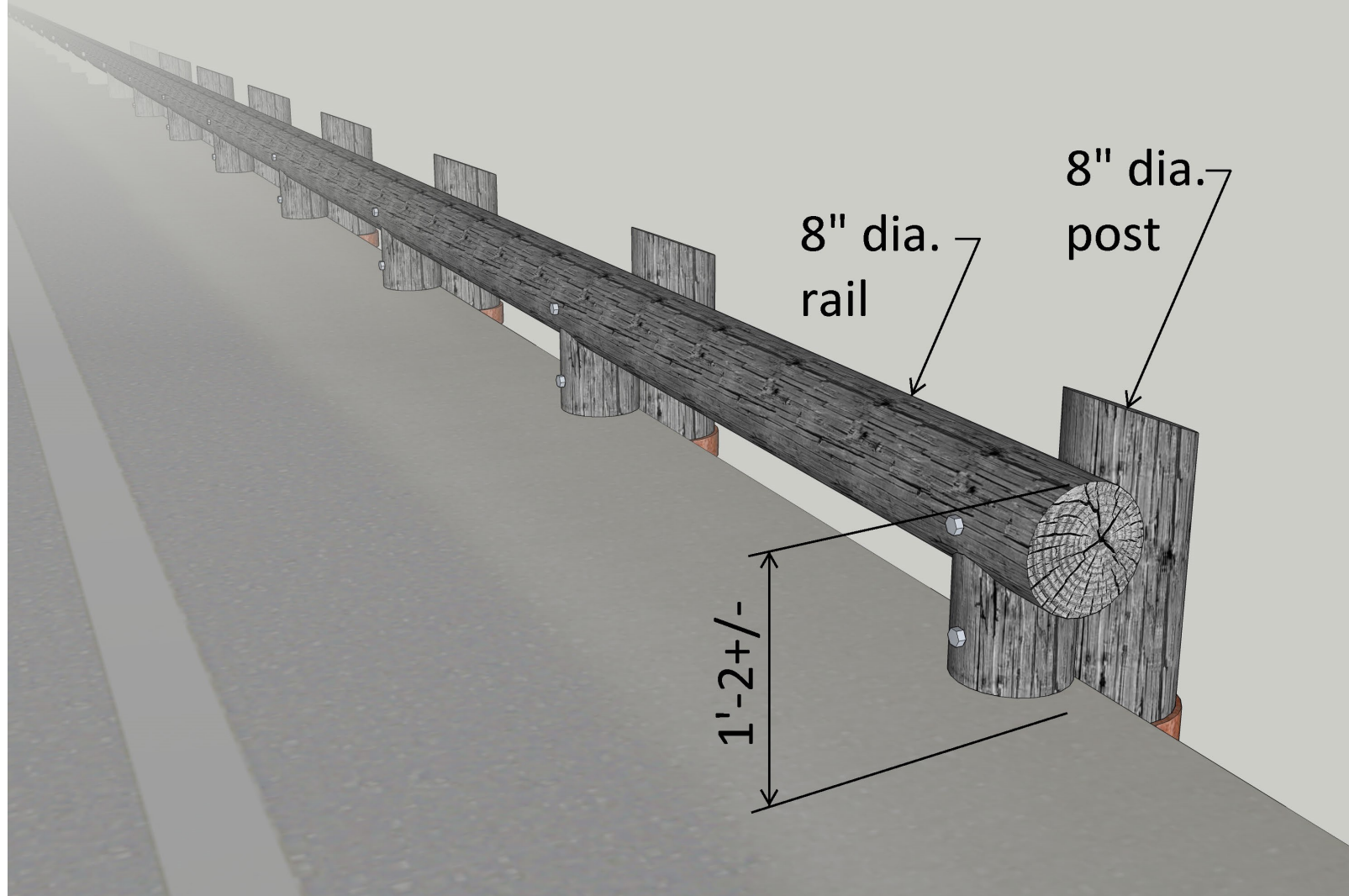

## Section 4: Timber Rails

### Timber Rail Type 2

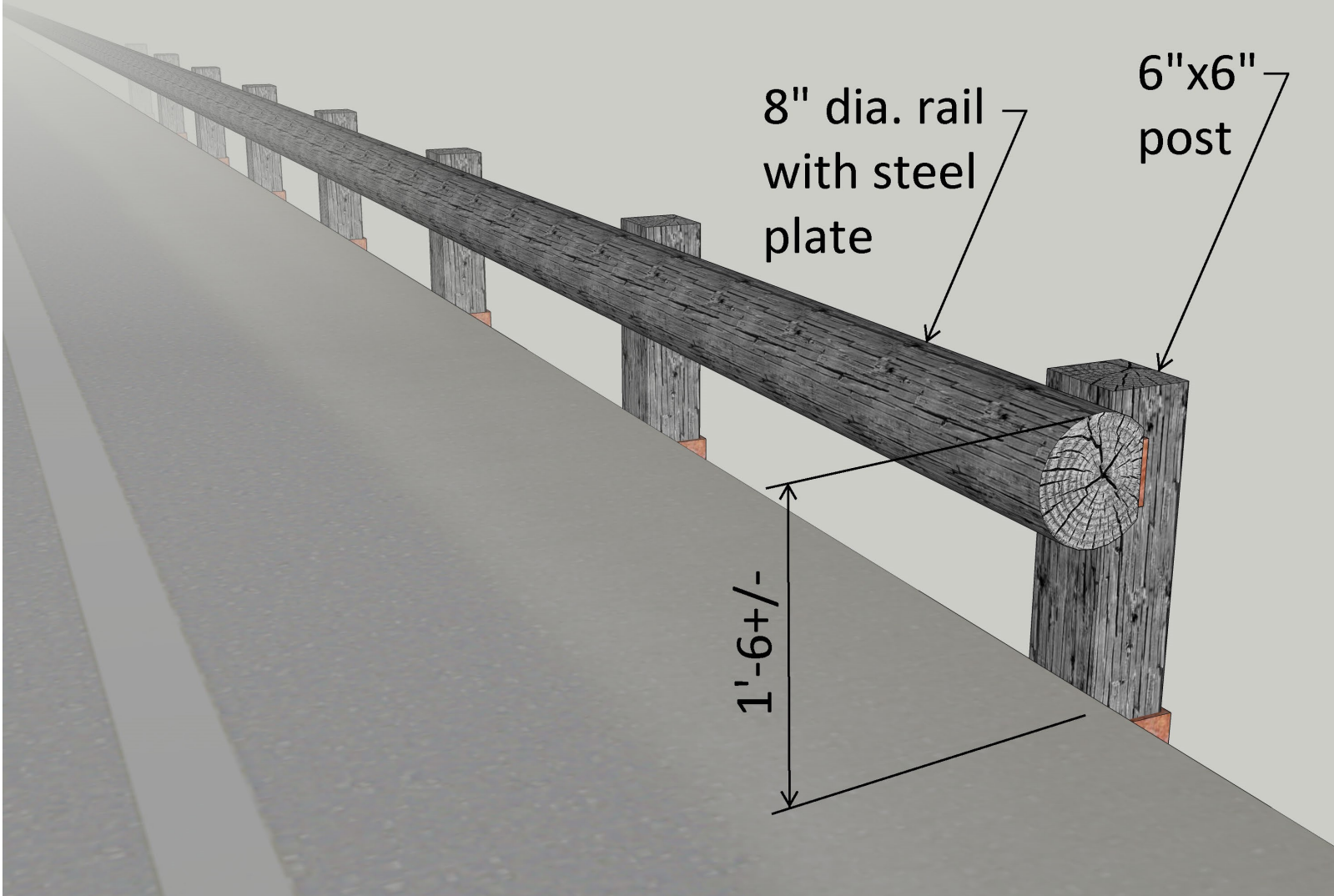

- Test Specification: unknown/not tested
- Rail may be compliant with AASHTO Specifications for Highway Bridges 2.7.1 Vehicular Railings for height, but other features and strength unknown
- AASHTO B.RH.01 Code: S10
- Notes: 1993 research performed on various timber rail curb shapes indicates that configurations similar to the rail shown may exhibit acceptable performance at low speed (15 MPH) and low impact angle (15 degrees); see TRP-03-31-93 for more information
- Example location: Backbone S.P., Delaware County (retrofit rail, pre-2010)
- W:\Highway\Bridge\MethodsSection\Barriers\Rail Guide\2\_Other Pre-MASH Rails Used by DOT\Timber Rails—Various

## Section 4: Timber Rails

### Timber Rail Type 3

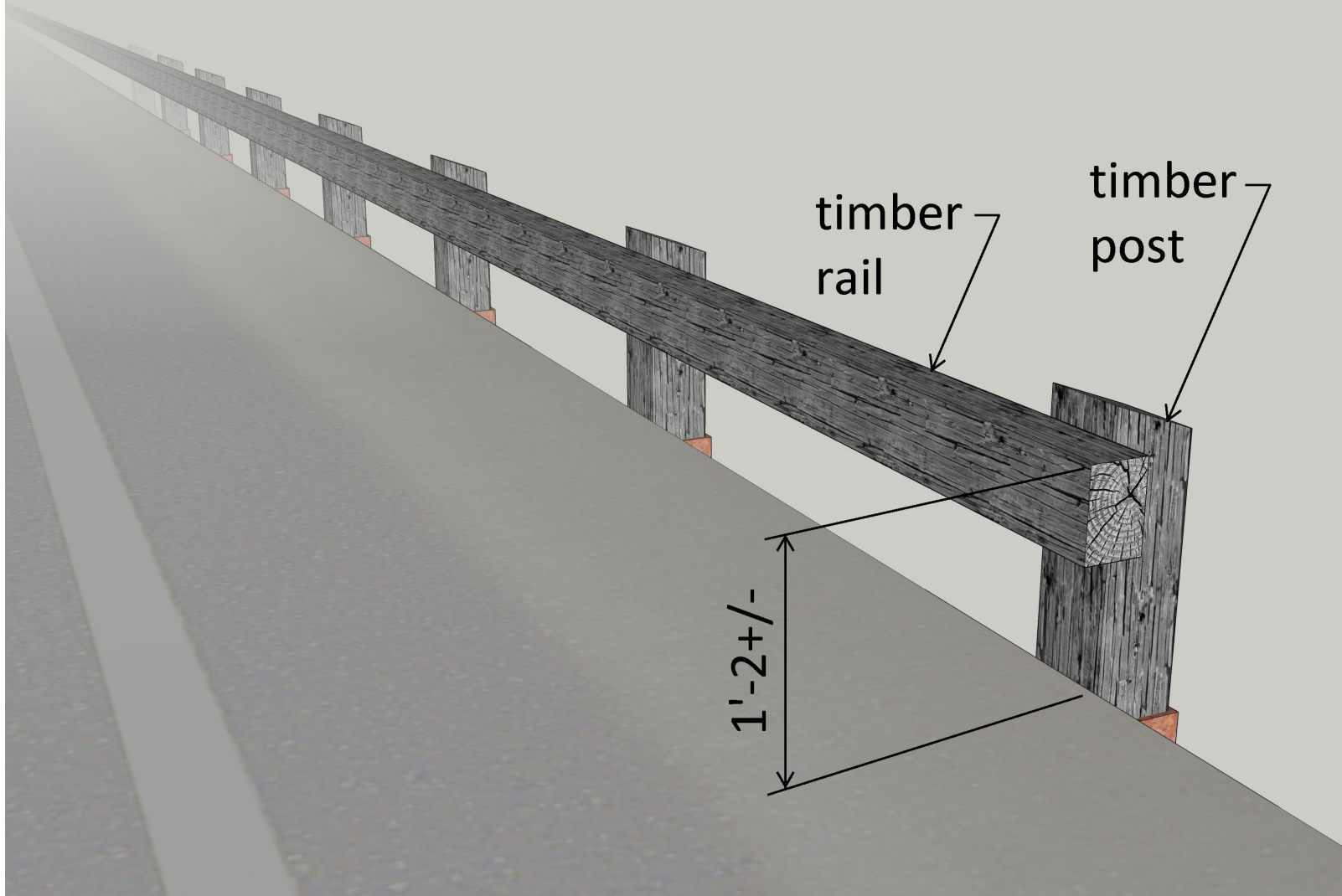

- Test Specification: unknown/not tested
- Rail is not compliant with AASHTO Specifications for Highway Bridges 2.7.1 Vehicular Railings (insufficient overall height); strength unknown
- AASHTO B.RH.01 Code: I
- Notes: 1993 research performed on various timber rail curb shapes indicates that configurations similar to the rail shown may exhibit acceptable performance at low speed (15 MPH) and low impact angle (15 degrees); see TRP-03-31-93 for more information
- Example location: Canyon Rd over Pease Creek, Ledges S.P., Boone Co. (pre-2010)
- W:\Highway\Bridge\MethodsSection\Barriers\Rail Guide\2\_Other Pre-MASH Rails Used by DOT\Timber Rails—Various

## Section 4: Timber Rails

### Timber Rail Type 4

- Test Specification: unknown/not tested
- Rail is not compliant with AASHTO Specifications for Highway Bridges 2.7.1 Vehicular Railings (no curb or parapet, excessive distance between rail and deck); strength unknown
- AASHTO B.RH.01 Code: 0
- Note: rails with similar light dimension lumber construction will likely receive the same B.RH.01 Code
- Example location: 410th St over Lost Branch Creek, Lucas Co.
- W:\Highway\Bridge\MethodsSection\Barriers\Rail Guide\2\_Other Pre-MASH Rails Used by DOT\Timber Rails—Various

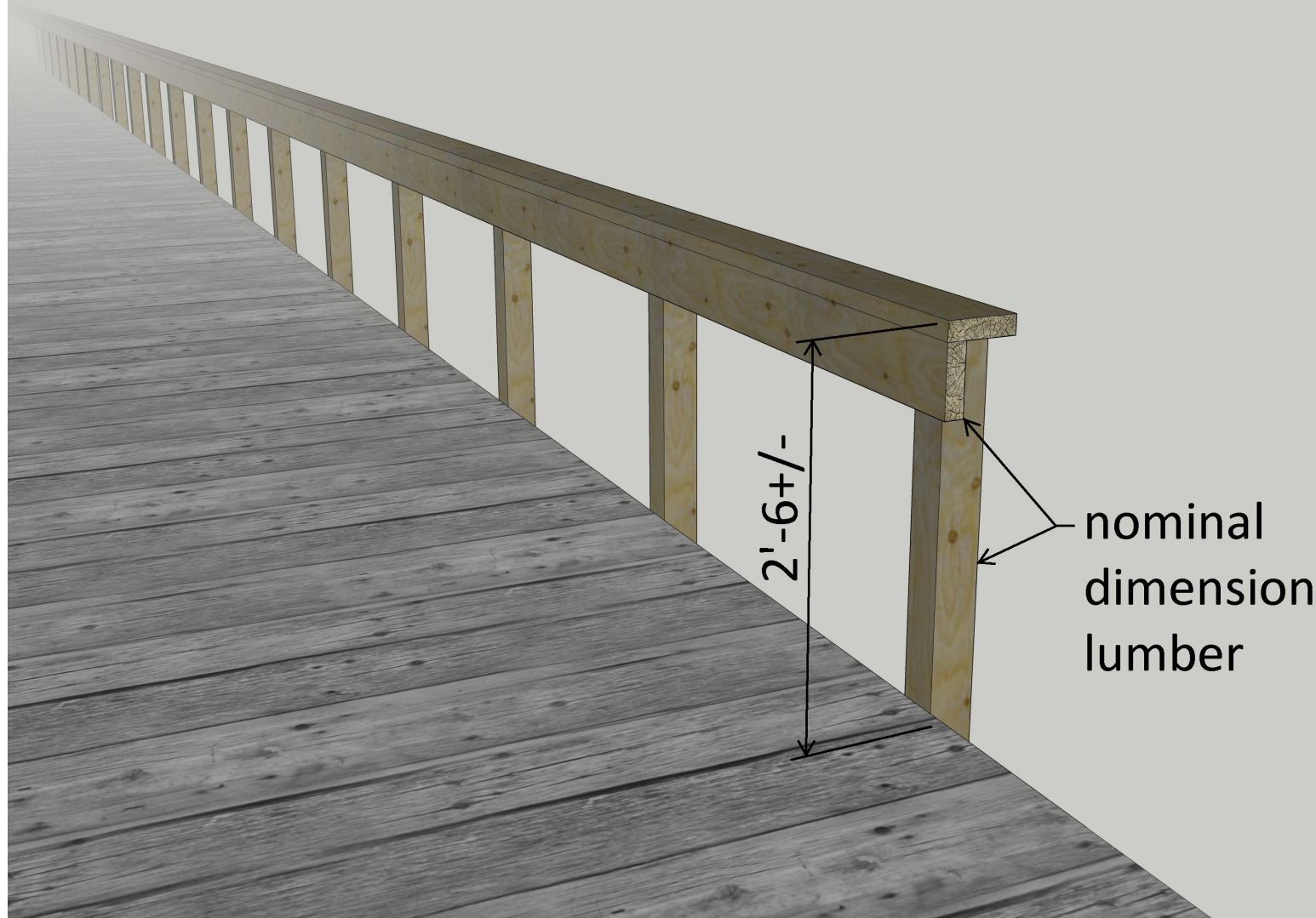



# Section 4: Timber Rails

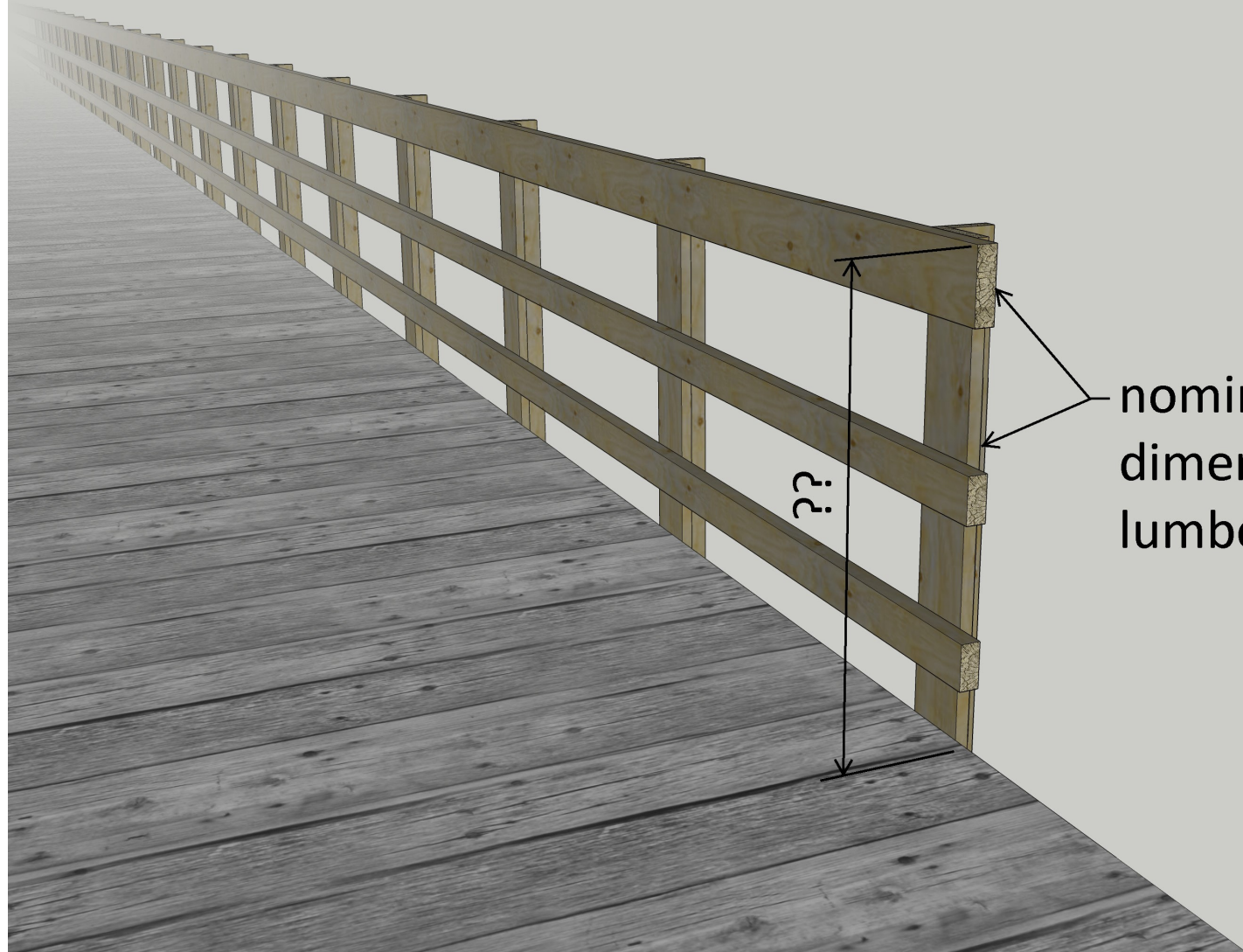

nominal  
dimension  
lumber

## Timber Rail Type 5

- Test Specification: unknown/not tested
- Rail is not compliant with AASHTO Specifications for Highway Bridges 2.7.1 Vehicular Railings (no curb or parapet); strength unknown
- AASHTO B.RH.01 Code: 0
- Example location:
- Note: rails with similar light dimension lumber construction will likely receive the same B.RH.01 Code
- W:\Highway\Bridge\MethodsSection\Barriers\Rail Guide\2\_Other Pre-MASH Rails Used by DOT\Timber Rails—Various

# Section 4: Timber Rails

## Timber Rail Type 6

- Test Specification: unknown/not tested
- Rail is not compliant with AASHTO Specifications for Highway Bridges 2.7.1 Vehicular Railings (1" max. vertical misalignment between rails); strength unknown
- AASHTO B.RH.01 Code: 0
- Note: rails with similar light dimension lumber construction will likely receive the same B.RH.01 Code
- Example location: bridge No. 225450 over RR, Lucas Co.
- W:\Highway\Bridge\MethodsSection\Barriers\Rail Guide\2\_Other Pre-MASH Rails Used by DOT\Timber Rails—Various

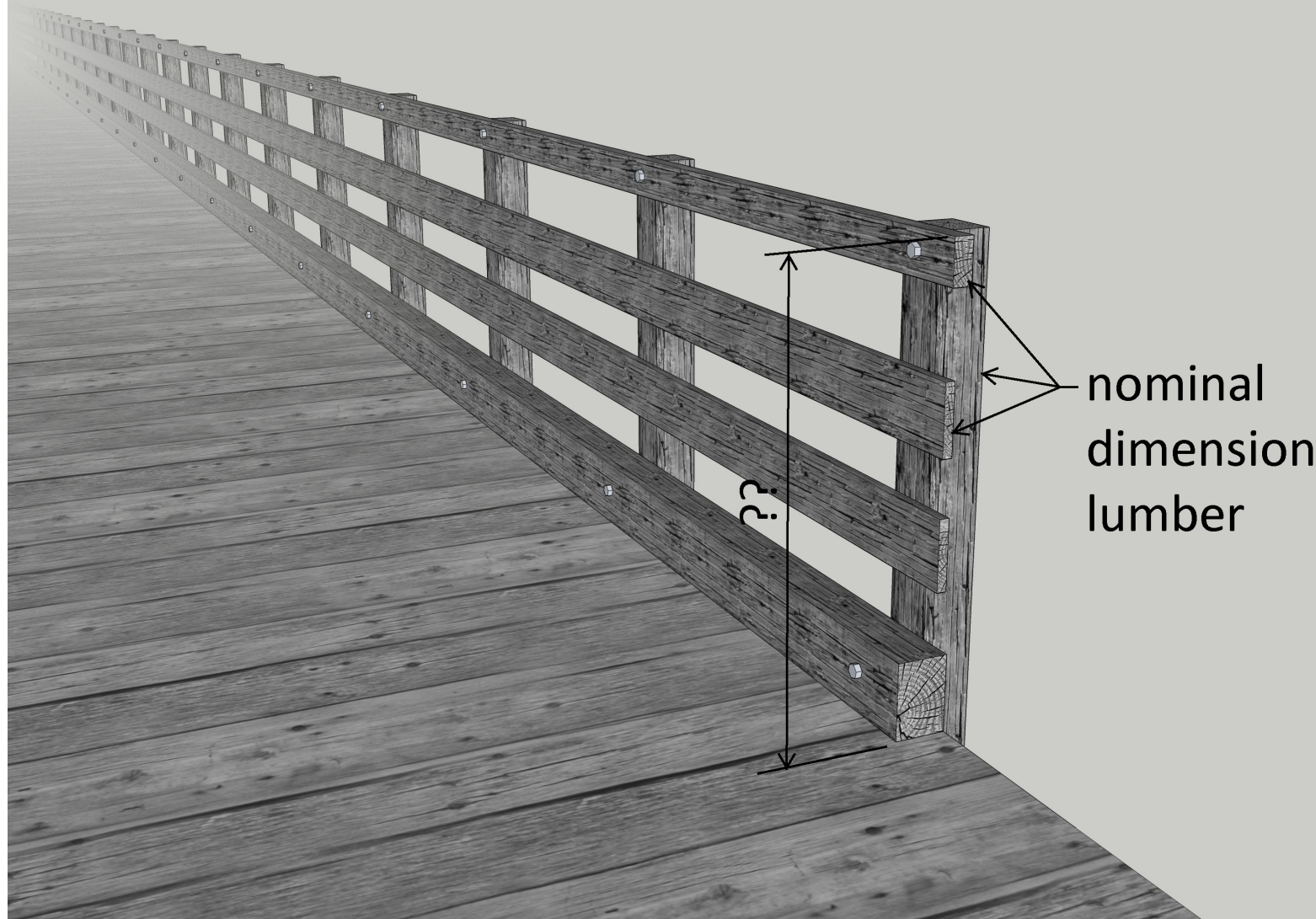

# Section 5: Thrie-Beam Rails (guardrail)

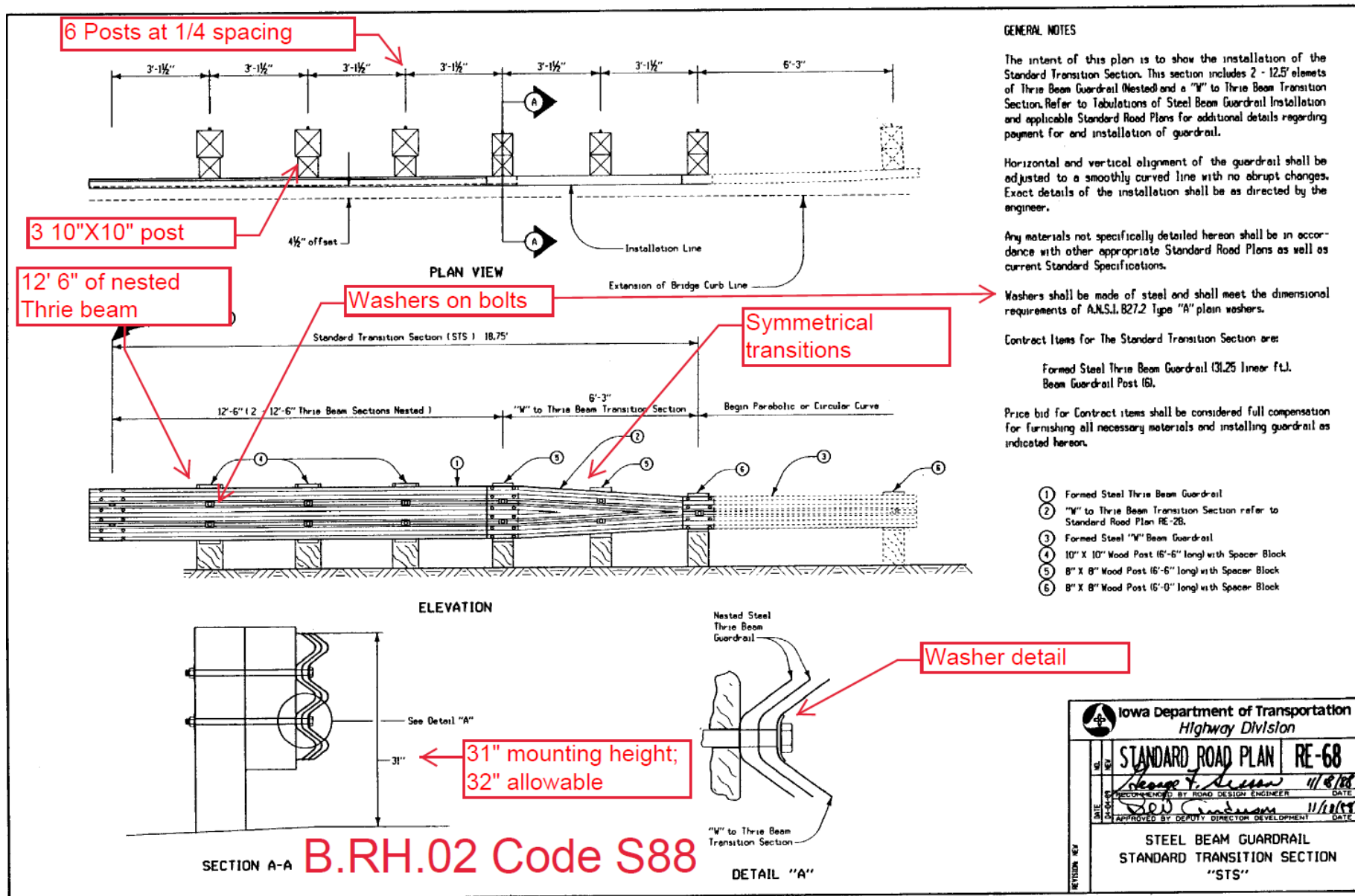

## Thrie-Beam Type 1

- Test Specification: unknown
- AASHTO B.RH.02 Code: S88
- 31" or 32" mounting height
- 12'-6 nested Thrie-Beam
- 3 10"x10" posts
- 6 posts at 3'-1 1/2" spacing
- Symmetrical transition
- Washers on bolts; if no washers on bolts, see Thrie-Beam Type 2
- W:\Highway\Bridge\Method sSection\Barriers\Rail Guide\6\_Guardrails from DB

Iowa Department of Transportation Highway Division	
STANDARD ROAD PLAN	RE-68
DESIGNED BY George F. Deason	DATE 11/8/88
RECOMMENDED BY ROAD DESIGN ENGINEER	DATE
APPROVED BY DEPUTY DIRECTOR DEVELOPMENT	DATE
STEEL BEAM GUARDRAIL STANDARD TRANSITION SECTION "STS"	

# Section 5: Thrie-Beam Rails (guardrail)

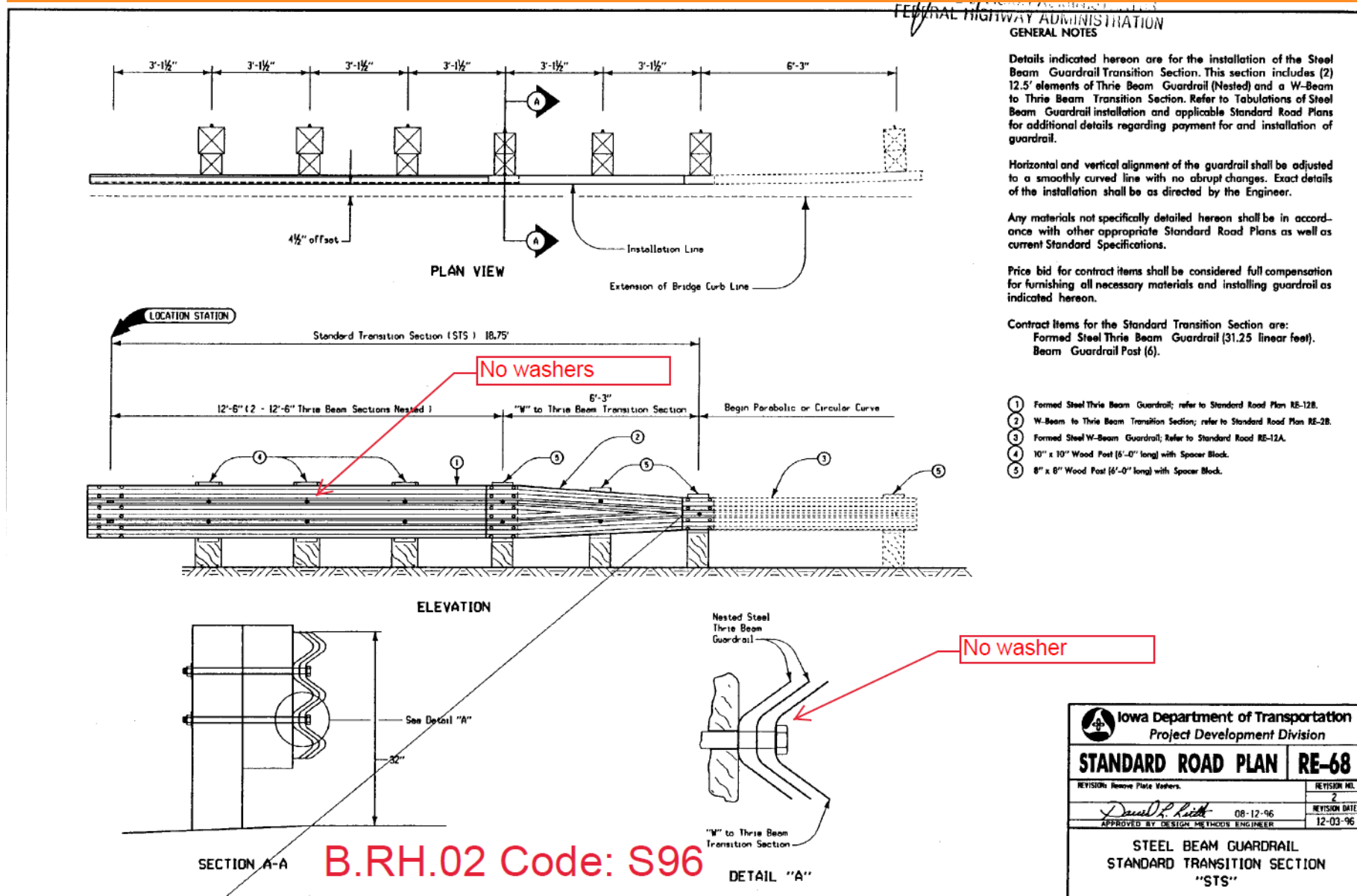

## Thrie-Beam Type 2

- Test Specification: unknown
- AASHTO B.RH.02 Code: S96
- 31" or 32" mounting height
- 12'-6" nested Thrie-Beam
- 3 10"x10" posts
- 6 posts at 3'-1 1/2" spacing
- Symmetrical transition
- No washers on bolts; if washers on bolts, see Thrie-Beam Type 1
- W:\Highway\Bridge\Method sSection\Barriers\Rail Guide\6\_Guardrails from DB

# Section 5: Thrie-Beam Rails (guardrail)

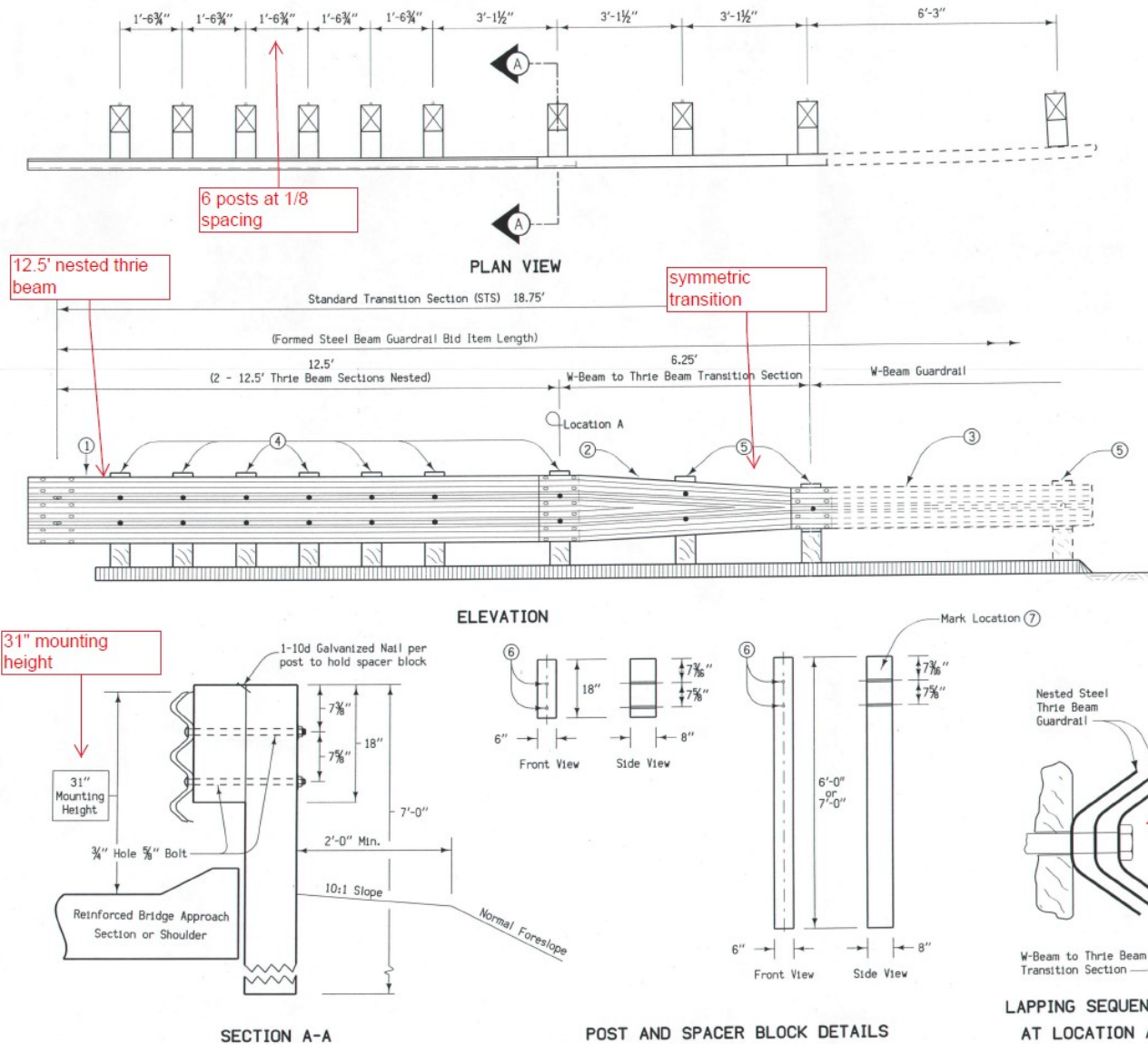

## GENERAL NOTES

Details indicated hereon are for the installation of the Steel Beam Guardrail Transition Section. This section includes (2) 12.5' elements of Thrie Beam Guardrail (Nested) and a W-Beam to Thrie Beam Transition Section. Refer to Tabulations of Steel Beam Guardrail installation and applicable Standard Road Plans for additional details regarding payment for and installation of guardrail.

Horizontal and vertical alignment of the guardrail shall be adjusted to a smoothly curved line with no abrupt changes.

- 1 Formed Steel Thrie Beam Guardrail; refer to Standard Road Plan RE-12B.
- 2 W-Beam to Thrie Beam Transition Section; refer to Standard Road Plan RE-2B.
- 3 Formed Steel W-Beam Guardrail; Refer to Standard Road RE-12A.
- 4 6" x 8" Wood Post (7'-0" long) with Spacer Block.
- 5 6" x 8" Wood Post (6'-0" long) with Spacer Block.
- 6 3/4" round holes in Wood Post and Spacer Block.
- 7 All 7' posts shall be marked with 1) the post length and 2) the supplier or manufacturer.

B.RH.02 Code: 3503

Note:  
For details of rail element, attachment bolts and nuts, splice bolts and nuts, and post backfill requirements see Standard Road Plan RE-12B.

 Iowa Department of Transportation Highway Division	
<b>STANDARD ROAD PLAN RE-68</b>	
REVISION: New Transition Design. Meets NCHRP Report 350, TL-3.	REVISION NO. 5
APPROVED BY: <i>William J. Atten</i> DESIGN METHODS ENGINEER	REVISION DATE 10-02-01
<b>STEEL BEAM GUARDRAIL STANDARD TRANSITION SECTION (STS)</b>	

## Thrie-Beam Type 3

- NCHRP 350, TL-3
- AASHTO B.RH.02 Code: 3503
- 31" mounting height
- 12'-6 nested Thrie-Beam
- 6 posts at 1'-6 3/4" spacing
- Symmetrical transition
- No washers on bolts
- W:\Highway\Bridge\Method sSection\Barriers\Rail Guide\6\_Guardrails from DB

# Section 5: Thrie-Beam Rails (guardrail)

## Thrie-Beam Type 4

- MASH 2009, TL-3
- AASHTO B.RH.02 Code: M103
- 31" mounting height
- 12'-6 nested Thrie-Beam
- 6'-3 single-ply Thrie-Beam
- 9 or 10 posts at 1'-6 3/4" spacing
- Asymmetrical transition
- W:\Highway\Bridge-Methods Section\Barriers\Rail Guide\6\_Guardrails from DB

At Bridge End Drains, cut Scour Protection (Scourstop and TRM) or remove rock as required to place post(s) such that Bridge End Drains abut post(s).

- ① Guardrail mounting height at barrier connection is 32 inches. Transition guardrail mounting height down to 31 inches over the length of the Barrier Transition Section.
- ② Possible curb. See project plans.
- ③ Depending on end anchor type, BTS Post #13 may be eliminated or modified. See BA-202.

Possible Contract Item:  
Steel Beam Guardrail Barrier Transition Section

Materials included in the Contract Item:

- (7) 6" x 8" x 6'-0" posts
- (6) 6" x 8" x 7'-0" posts
- (12) 6" x 12" x 19" blockouts
- (1) 6" x 12" x 14 1/2" blockout
- (1) Asymmetrical Transition Section
- (2) 12'-6" Thrie-Beam rail sections\*
- (1) 6'-3" Thrie-Beam rail section\*
- Approved bolts, nuts, and washers
- Refer to BA-200 for guardrail components

\* One 18'-9" Thrie-Beam rail section may be substituted for one of the 12'-6" sections and the 6'-3" section as shown

 Iowa Department of Transportation	REVISION
	1   10-19-10
<b>STANDARD ROAD PLAN</b>	<b>BA-201</b>
SHEET 1 of 2	
REVISIONS: Removed dimensions from Section A-A and Section B-B on Sheet 1. Clarified nested section options.	
 APPROVED BY DESIGN METHOD ENGINEER	
<b>STEEL BEAM GUARDRAIL BARRIER TRANSITION SECTION</b>	

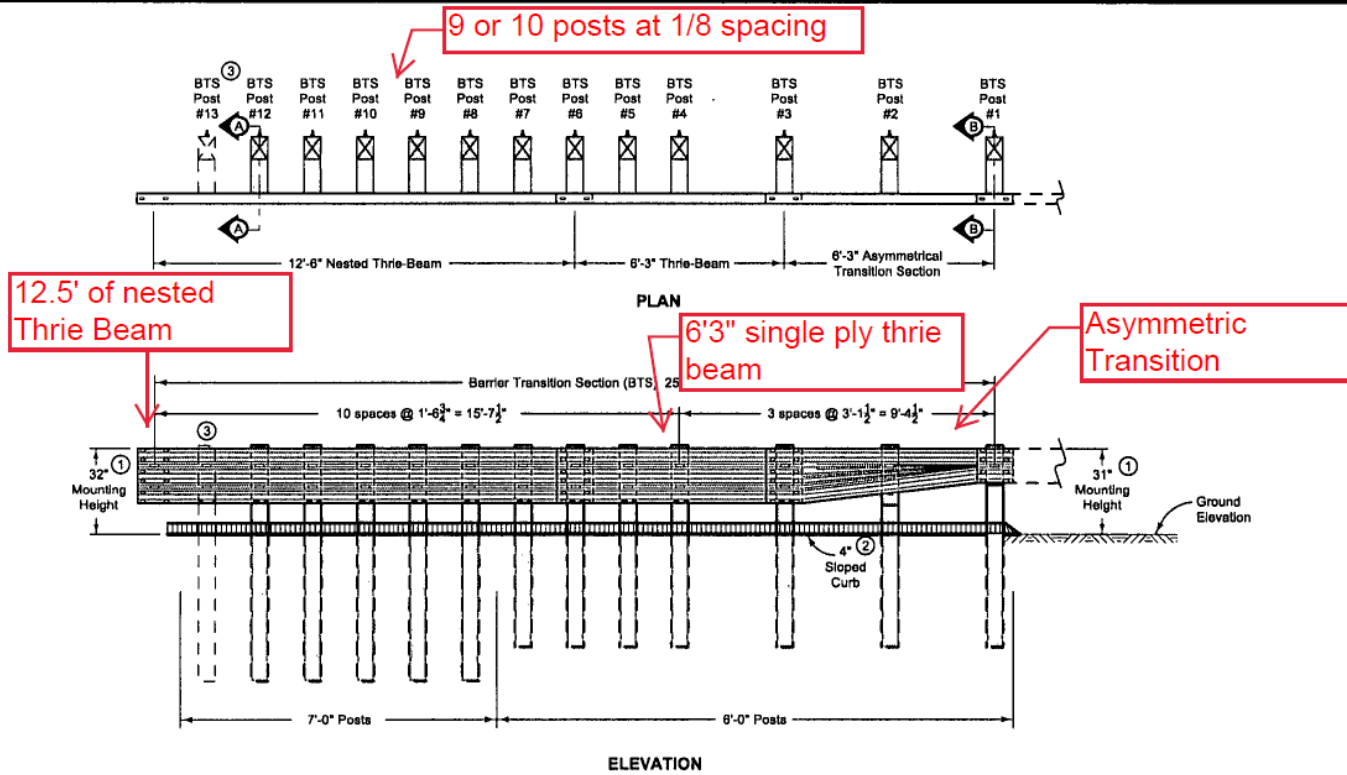

12.5' of nested Thrie Beam

9 or 10 posts at 1/8 spacing

6'3" single ply thrie beam

Asymmetric Transition

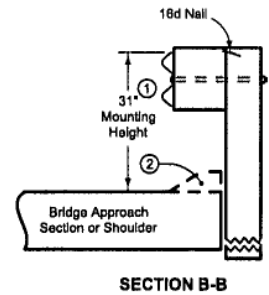
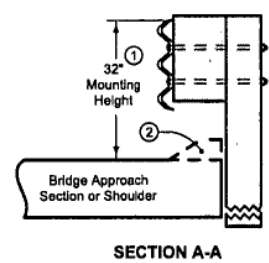

B.RH.02 Code: M103

# Section 5: Thrie-Beam Rails (guardrail)

## Thrie-Beam Type 5

- MASH 2009, TL-3
- AASHTO B.RH.02 Code: M143
- 31" or 32" mounting height
- 12'-6 nested Thrie-Beam
- 6'-3 single-ply Thrie-Beam
- 12'-6 nested W-Beam
- 9 or 10 posts at 1'-6 3/4" spacing
- Asymmetrical transition
- W:\Highway\Bridge\Methods Section\Barriers\Rail Guide\6\_Guardrails from DB

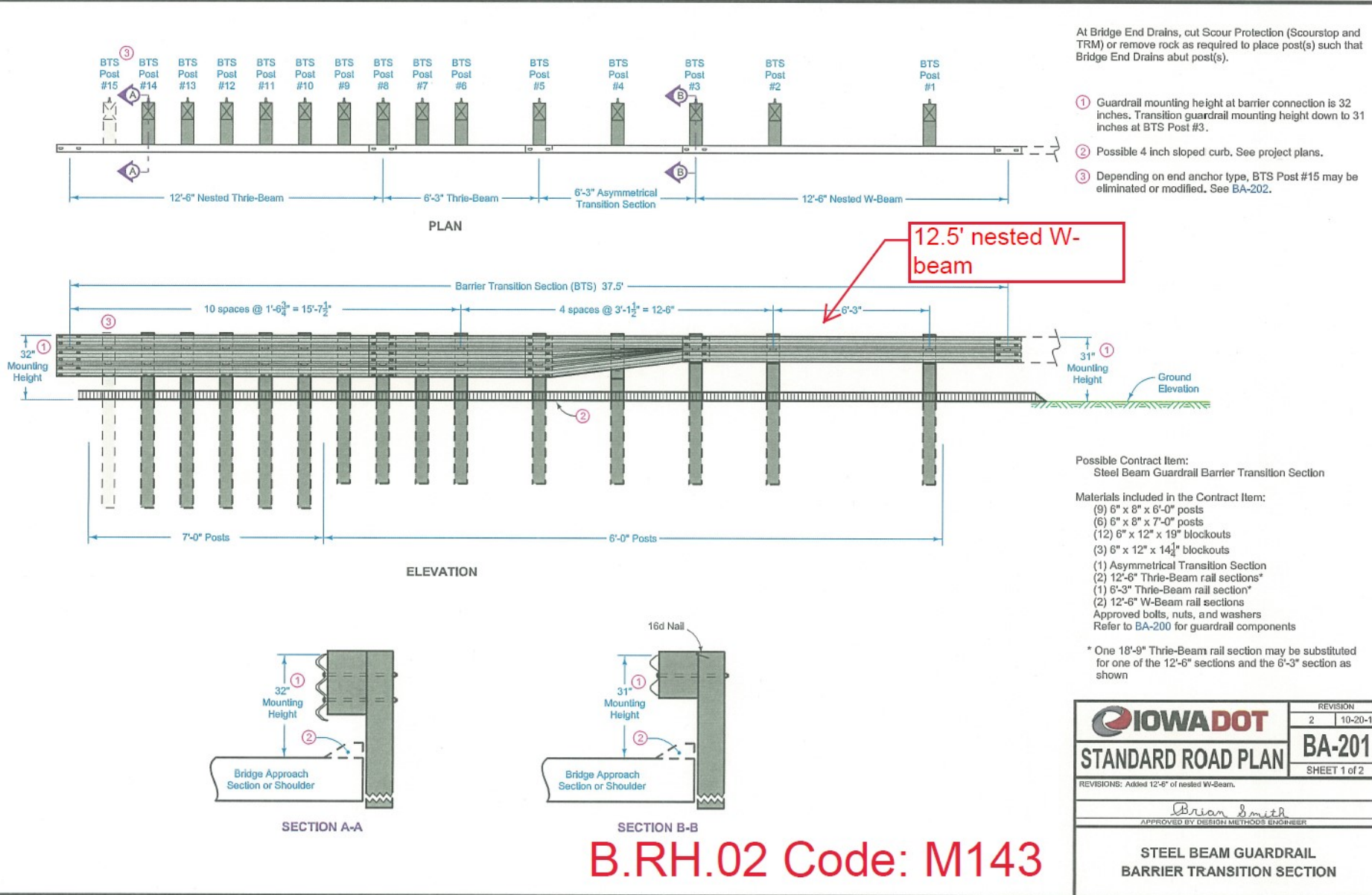

# Section 5: Thrie-Beam Rails (guardrail)

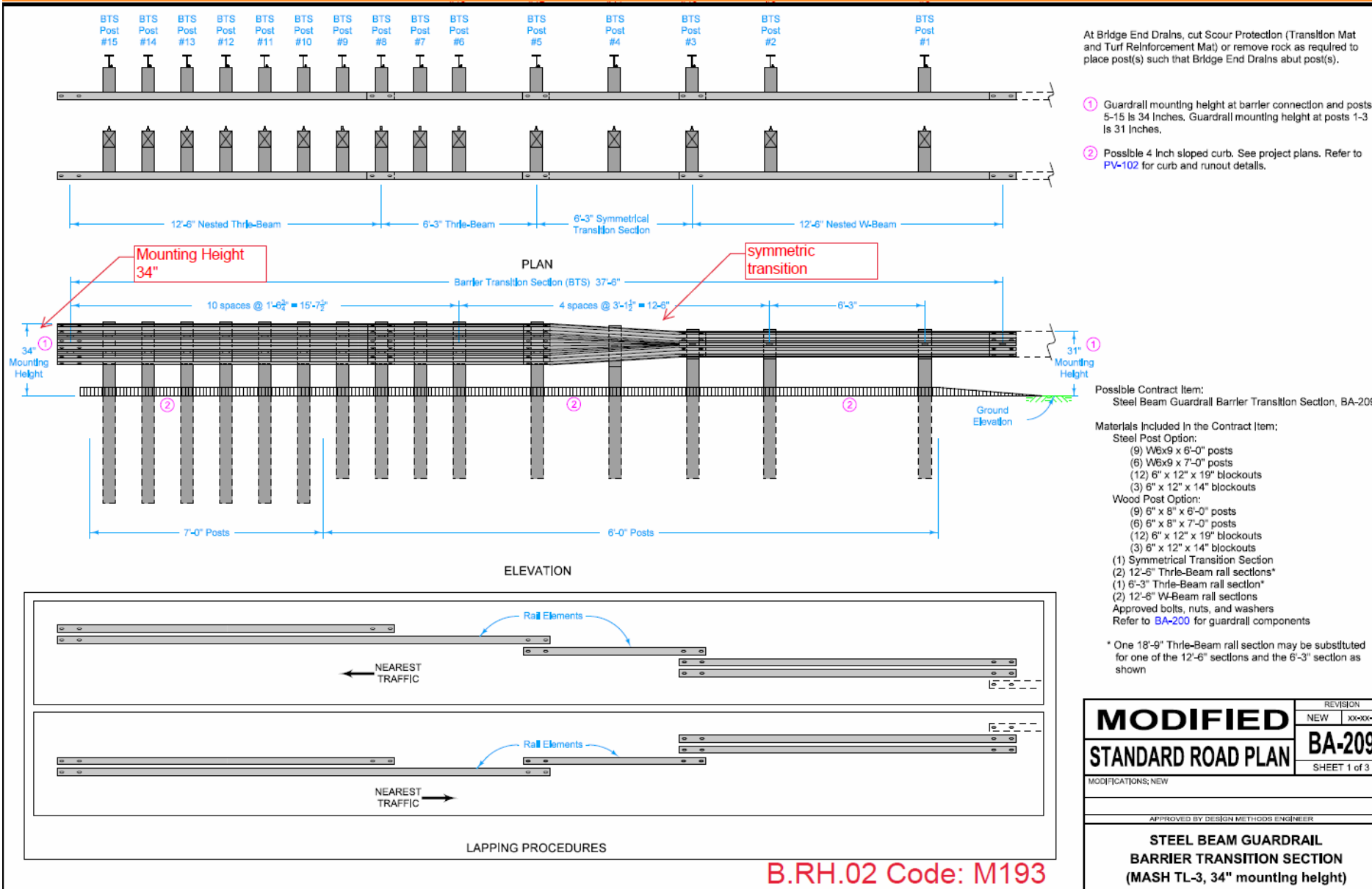

B.RH.02 Code: M193

## Thrie-Beam Type 6

- MASH 2016, TL-3
- AASHTO B.RH.02 Code: M193
- 34" mounting height
- 12'-6 nested Thrie-Beam
- 6'-3 single-ply Thrie-Beam
- 12'-6 nested W-Beam
- 9 or 10 posts at 1'-6 3/4" spacing
- Symmetrical transition
- W:\Highway\Bridge\Methods Section\Barriers\Rail Guide\6\_Guardrails from DB

<b>MODIFIED</b>	REVISION	
	NEW	xx-xx-xx
<b>STANDARD ROAD PLAN</b>	<b>BA-209</b>	
MODIFICATIONS: NEW	SHEET 1 of 3	
APPROVED BY DESIGN METHODS ENGINEER		
<b>STEEL BEAM GUARDRAIL BARRIER TRANSITION SECTION (MASH TL-3, 34" mounting height)</b>		



# Section 5: Thrie-Beam Rails (guardrail)

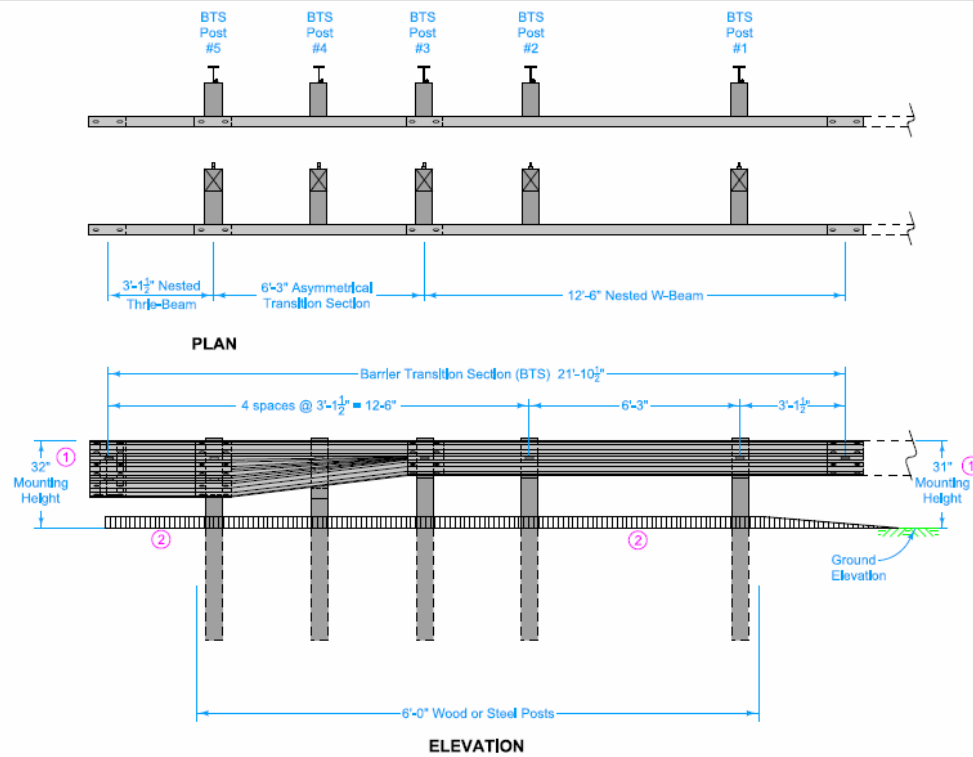

At Bridge End Drains, cut Scour Protection (Transition Mat and Turf Reinforcement Mat) or remove rock as required to place post(s) such that Bridge End Drains abut post(s).

- ① Guardrail mounting height at barrier connection is 32 inches. Transition guardrail mounting height down to 31 inches at BTS Post #3.
- ② Possible 4 inch sloped curb. See project plans. Refer to PV-102 for curb and runoff details.

Possible Contract Item:  
Steel Beam Guardrail Barrier Transition Section, BA-221

Materials Included In the Contract Item:

- Steel Post Option:
- (5) W6x9 x 6'-0" posts
  - (2) 6" x 12" x 19" blockouts
  - (3) 6" x 12" x 14" blockouts

- Wood Post Option:
- (5) 6" x 8" x 6'-0" posts
  - (2) 6" x 12" x 19" blockouts
  - (3) 6" x 12" x 14" blockouts

- (1) Asymmetrical Transition Section
- (2) 3'-1 1/2" Thrie-Beam rail sections
- (2) 12'-6" W-Beam rail sections

Approved bolts, nuts, and washers  
Refer to BA-200 for guardrail components

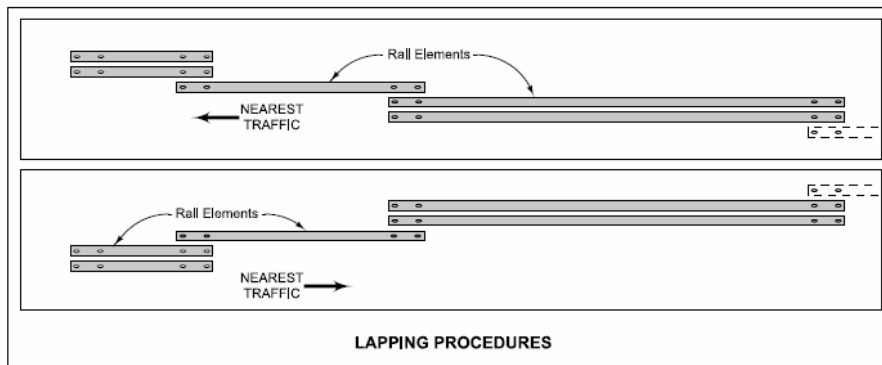

B.RH.02 Code: M112

## Thrie-Beam Type 7

- MASH 2009, TL-2
- AASHTO B.RH.02 Code: M112
- 32" mounting height
- 3'-1 1/2" nested Thrie-Beam
- 12'-6 nested W-Beam
- 4 posts at 3'-1 1/2" spacing
- Asymmetrical transition
- W:\Highway\Bridge\Methods Section\Barriers\Rail Guide\6\_Guardrails from DB

 <b>STANDARD ROAD PLAN</b>	REVISION 3   10-19-22
	<b>BA-221</b> SHEET 1 of 3
REVISIONS: Revised curb note,	
 APPROVED BY DESIGN METHODS ENGINEER	
<b>STEEL BEAM GUARDRAIL                  BARRIER TRANSITION SECTION                  (MASH TL-2)</b>	

# Section 6: W-Beam Rails (guardrail)

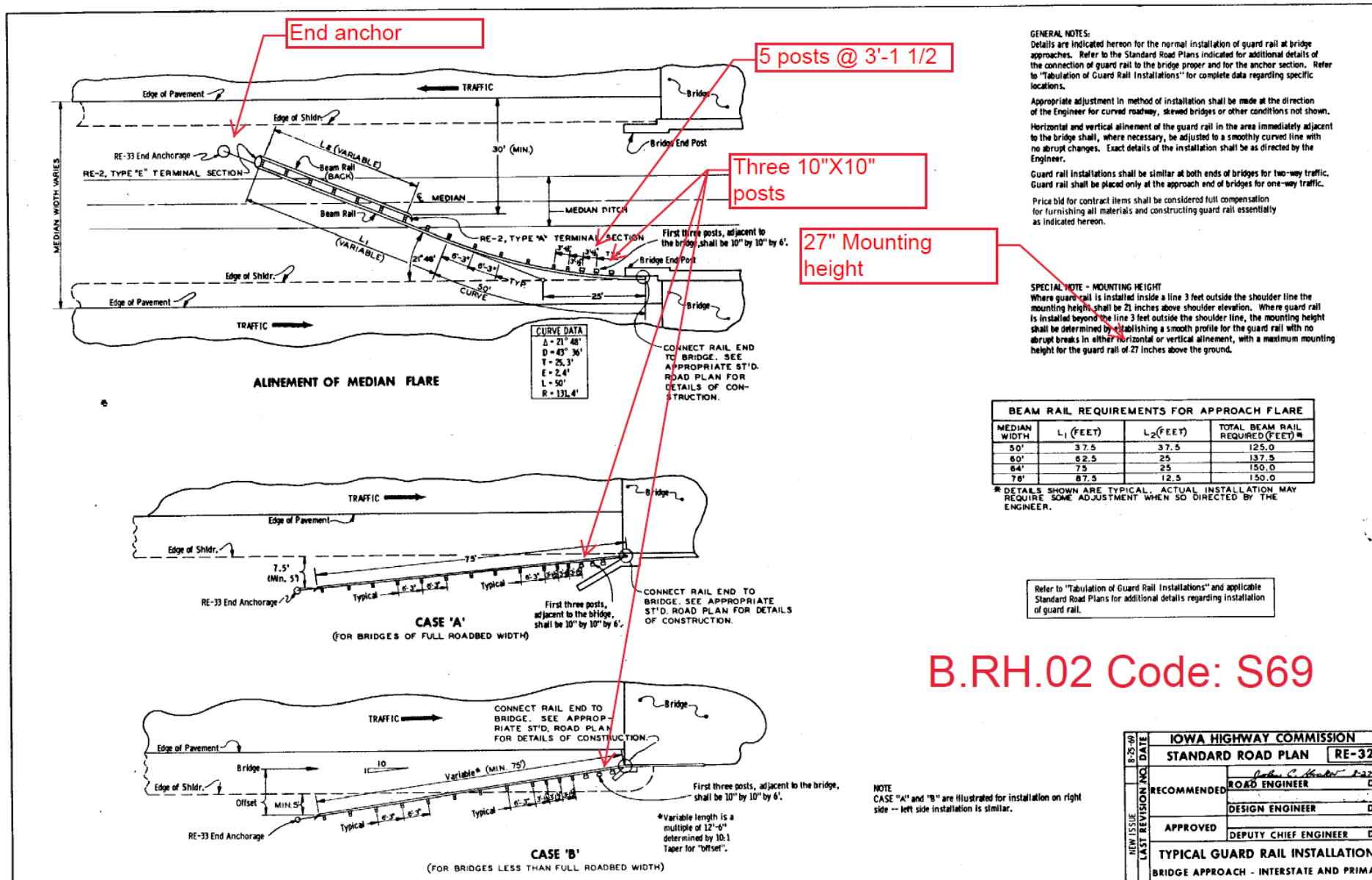

## W-Beam Type 1

- Test Specification: unknown
- AASHTO B.RH.02 Code: S69
- 27" mounting height
- 3 10"x10" posts
- 5 posts at 3'-1 1/2" spacing; if 7 posts at 3'-1 1/2" spa. see W-Beam Type 2; if 6 posts at 3'-1 1/2" spa. see W-Beam Type 3
- End anchor
- W:\Highway\Bridge\Method sSection\Barriers\Rail Guide\6\_Guardrails from DB

# Section 6: W-Beam Rails (guardrail)

## W-Beam Type 2

- Test Specification: unknown
- AASHTO B.RH.02 Code: S71
- 27" mounting height
- 3 10"x10" posts
- 7 posts at 3'-1 1/2" spacing; if 5 posts at 3'-1 1/2" spa. see W-Beam Type 1; if 6 posts at 3'-1 1/2" spa. see W-Beam Type 3
- End anchor
- W:\Highway\Bridge\Method sSection\Barriers\Rail Guide\6\_Guardrails from DB

**ALIGNMENT OF MEDIAN FLARE**

TRAFFIC ←

EDGE OF PAVEMENT

EDGE OF SHOULDER

BRIDGE

BRIDGE END POST

RE-33 END ANCHORAGE

RE-2 TYPE "E" TERMINAL SECTION

30' MIN.

DETAIL "A"

RE-2 TYPE "A" TERMINAL SECTION

MEDIAN DITCH

POST WITH 2 SPACERS

BEAM RAIL

21° 48'

6'-3"

30' CURVE

25'

BEGIN CURVE

TRAFFIC →

EDGE OF PAVEMENT

EDGE OF SHOULDER

CONNECT RAIL END TO BRIDGE. SEE APPROPRIATE STD. ROAD PLAN FOR DETAILS OF CONSTRUCTION.

First three posts, adjacent to the bridge shall be 10" x 10" x 6 ft. First seven posts shall be spaced at 3'-1 1/2"

"Y" IS OFFSET FROM INSTALLATION LINE TO LINE OF FACE RAIL. "X" IS TANGENT DISTANCE FROM BEGIN CURVE POINT

OFFSET DATA	
30	3.47
40	6.24
50	9.84
60	13.56
70	17.27
80	20.98
90	24.70
100	28.41

CURVE DATA	
Δ=21° 48'	
D=43° 36'	
T=25.3'	
E=2.4'	
L=50'	
R=131.4'	

**GENERAL NOTES:**  
 Details are indicated herein for the normal installation of guard rail in median at bridge approaches. Refer to "Tabulation of Guard Rail Installations" for complete data regarding specific locations.

Horizontal and vertical alignment of the guard rail in the area immediately adjacent to the bridge shall, where necessary, be adjusted to a smoothly curve line with no abrupt changes. Appropriate adjustment in method of installati shall be made for curved roadway, skewed bridges or other conditions not shown. Exact details of the installation shall be as directed by the Engineer.

Price bid for contract items shall be considered full compensation for furnishing all materials and constructing guard rail essentially as indicated herein.

Contract items for guard rail construction are:  
 Formed Steel Beam Railing  
 Beam Guard Rail Post  
 Beam Guard Rail Anchor

Necessary Delineators shall be included and considered incidental to other work.

**SPECIAL NOTE - MOUNTING HEIGHT**  
 Where guard rail is installed inside a line 3 feet outside the shoulder line the mounting height shall be 21 inches above shoulder elevation. Where guard rail is installed beyond the line 3 feet outside the shoulder line, the mounting height shall be determined by establishing a smooth profile for the guard rail with no abrupt breaks in either horizontal or vertical alignment, with a maximum mounting height for the guard rail of 27 inches above the ground.

**BEAM RAIL REQUIREMENTS FOR APPROACH FLARE**

MEDIAN WIDTH	L1 (FEET)		POST			TOTAL BEAM RAIL REQUIRED (FEET)**
	L1 (FEET)	L2 (FEET)	8" x 8" SINGLE SPACER	8" x 8" DOUBLE SPACER	10" x 10"	
50'	37.5	37.5	7	7	3	125.0
60'	50.0	25.0	11	5	3	125.0
64'	50.0	12.5	13	3	3	112.5
76'	50.0	0	16	0	3	100.0

\* Requires posts with 2 spacers.  
 \*\* Details shown are typical. Actual installation may require some adjustment when so directed by the engineer.

**DETAIL "A"**

BACKING RAIL

BEAM GUARD RAIL

SPACER BLOCK

POST WITH 2 SPACERS

SPACER BLOCK

APPROACH SIDE RAIL

**TYPICAL INSTALLATION DUAL ROADWAY**

BRIDGE

TRAFFIC ←

GUARD RAIL

GUARD RAIL

TRAFFIC →

BRIDGE

① One M9-3 (Vertical) amber delineator shall be required at each side of all bridge ends for approach traffic (2 at one-way, 4 at two-way).

NOTE: See Standard Road Plan RE-7 for details of delineators.

**B.RH.02 Code: S71**

NEW ISSUE	LAST REVISION	NO.	DATE	IOWA HIGHWAY COMMISSION	
				STANDARD ROAD PLAN	RE-32A
				RECOMMENDED	DATE
				DESIGN ENGINEER	DATE
				APPROVED	DATE
				DIRECTOR OF ENGINEERING	DATE
TYPICAL GUARD RAIL INSTALLATION					
BRIDGE APPROACH - INTERSTATE AND PRIMARY					

# Section 6: W-Beam Rails (guardrail)

## W-Beam Type 3

- Test Specification: unknown
- AASHTO B.RH.02 Code: S79
- 27" mounting height
- 3 10"x10" posts
- 6 posts at 3'-1 1/2" spacing; if 5 posts at 3'-1 1/2" spa., see W-Beam Type 1; if 7 posts at 3'-1 1/2" spa. see W-Beam Type 2
- End anchor
- W:\Highway\Bridge\Method sSection\Barriers\Rail Guide\6\_Guardrails from DB

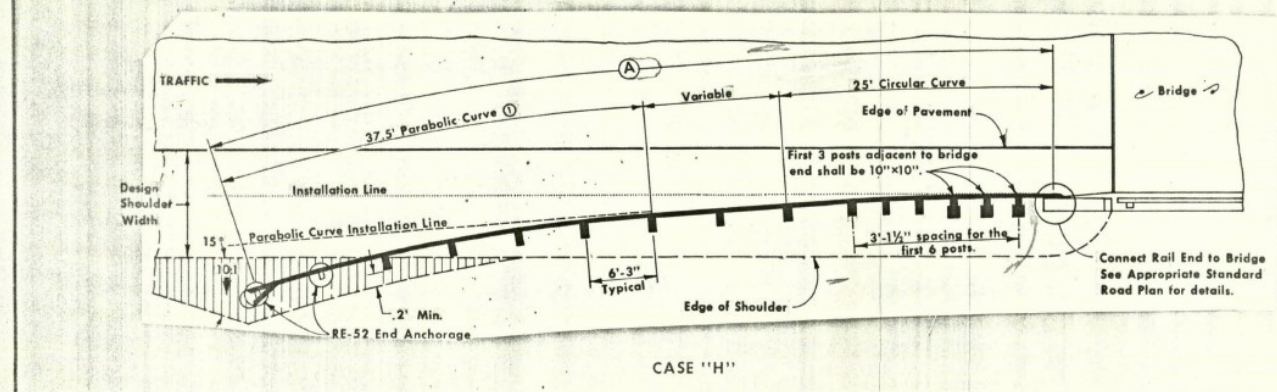
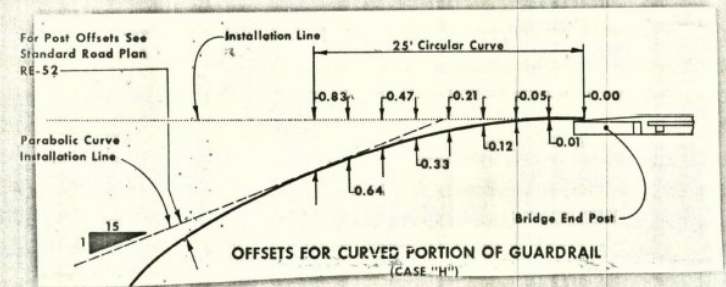
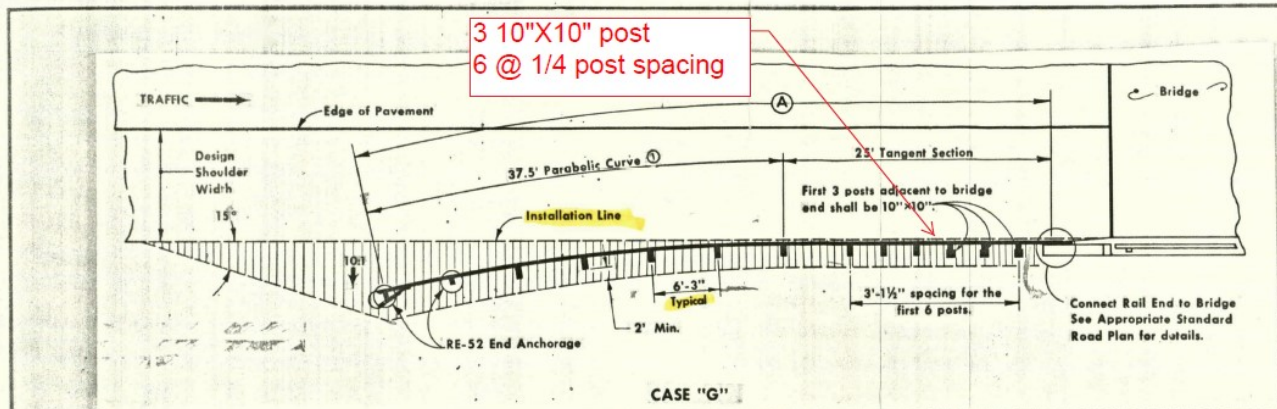

**GENERAL NOTES:**

Details indicated hereon are for the typical installation of guardrail at approaches to bridges constructed with other than concrete barrier rail. Refer to project plans, including Tabulation of Beam Guardrail Installations as well as other Standard Road Plans for additional requirements for individual installations.

It is the intent of this plan to provide a 10:1 slope from the edge of the shoulder to two feet back of the guardrail post as shown hereon. For specific requirements and details refer to other drawings and tabulations.

Horizontal and vertical alignment of the guardrail in the area immediately adjacent to the bridge shall, where necessary, be adjusted to a smoothly curved line with no abrupt changes. Appropriate adjustment in method of installation shall be made for curved roadway, skewed bridges, or other conditions not shown. Exact details of the installation shall be as directed by the engineer.

Guardrail shall be lapped towards the structure.

Price bid for contract items shall be considered full compensation for furnishing all materials and constructing guardrail essentially as indicated hereon.

Contract items for beam guardrail are:  
 Formed Steel Beam Guardrail  
 Beam Guardrail Posts  
 RE-52 Beam Guardrail End Anchorages

See other drawings at locations where cable guardrail overlaps the bridge approach guardrail.

Assumed 27" mounting height

① Refer to Standard Road Plan RE-52 for details of Parabolic Curve Section.

B.RH.02 Code: S79

		<b>Highway Division</b>	
STANDARD ROAD PLAN		RE-57	
RECOMMENDED	ROAD DESIGN ENGINEER	DATE	
APPROVED	DEPUTY CHIEF ENGINEER	DATE	
GUARDRAIL INSTALLATION BRIDGE APPROACH (BRIDGE WITH OTHER THAN CONC. BARRIER RAIL)			
COUNTY	3:9:79	DATE	

# Section 7: Crash Cushions

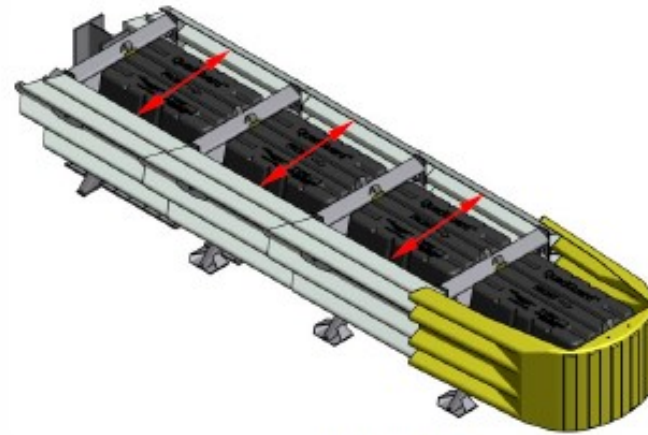

Parallel system

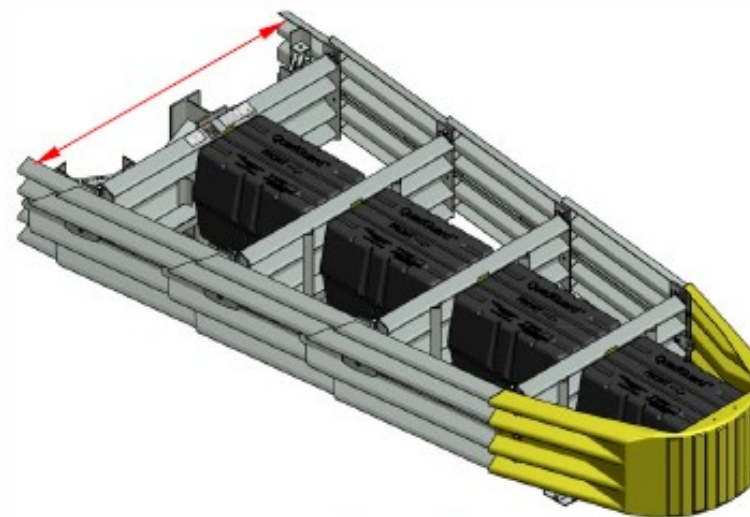

Wide system

## QuadGuard

- Test Specification: NCHRP Report 350 (TL-1 for 1 or 2 bays, TL-2 for 3 to 5 bays, TL-3 for 6 bays)
- Important Note: Although it contains a cartridge, the nose section of the attenuator DOES NOT count as a bay
- AASHTO B.RH.02 Code:
 

No. of Bays	Code
1 or 2	3501
3 to 5	3502
6	3503
- W:\Highway\Bridge\Method sSection\Barriers\Rail Guide\B\_Crash Cushions from DB

# Section 7: Crash Cushions

## QuadGuard® Elite CRASH CUSHIONS



## QuadGuard Elite

- Test Specification: NCHRP Report 350 (TL-2 for 5 or 7 bays, TL-3 for 8 or 11 bays)
- Important Note: The nose section of the attenuator DOES NOT count as a bay
- AASHTO B.RH.02 Code:

<u>No. of Bays</u>	<u>Code</u>
5 or 7	3502
8 or 11	3503
- W:\Highway\Bridge\Method sSection\Barriers\Rail Guide\8\_Crash Cushions from DB

# Section 7: Crash Cushions

## QUADTREND<sup>®</sup> 350 SYSTEM

THE END TREATMENT FOR ROADSIDE CONCRETE BARRIERS



## QuadTrend

- Test Specification: NCHRP Report 350 (TL-3)
- AASHTO B.RH.02 Code: 3503
- W:\Highway\Bridge\MethodsSection\Barriers\Rail Guide\8\_Crash Cushions from DB

# Section 7: Crash Cushions

## HEART™ CRASH CUSHIONS



## HEART

- Test Specification: NCHRP Report 350 (TL-3)
- AASHTO B.RH.02 Code: 3503
- W:\Highway\Bridge\Method sSection\Barriers\Rail Guide\8\_Crash Cushions from DB



# Section 7: Crash Cushions



## Smart Cushion

- Test Specification: NCHRP Report 350 (TL-2 for 13.5' length, TL-3 for 21.5' length)
- AASHTO B.RH.02 Code:
 

Length	Code
13.5'	3502
21.5'	3503
- W:\Highway\Bridge\Method sSection\Barriers\Rail Guide\8\_Crash Cushions from DB

Smart Cushion® Dimensions	Test Level 2 NCHRP 350	Test Level 3 NCHRP 350
A	13' 6"	21' 6"
B	24"	24"
C	34"	34"
Weight	2470 lbs.	3450 lbs.

Weights are for attenuators only

# Section 7: Crash Cushions

## THE HEX-FOAM® SANDWICH SYSTEM

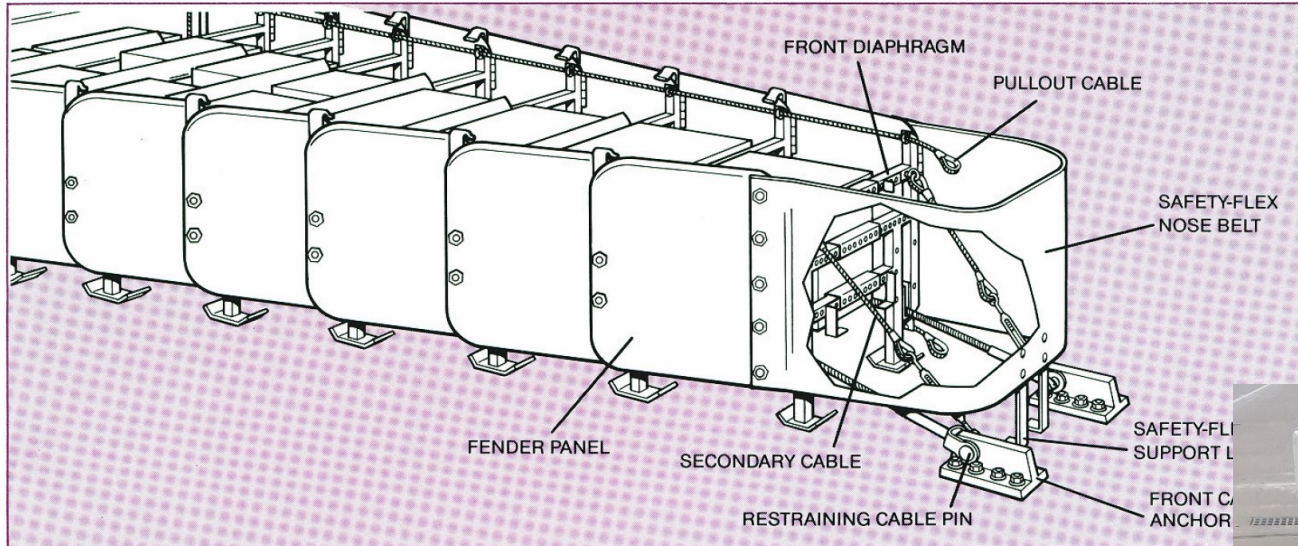

## Hex-Foam Sandwich

- Test Specification: not tested
- AASHTO B.RH.02 Code: I
- W:\Highway\Bridge\Method sSection\Barriers\Rail Guide\8\_Crash Cushions from DB

# Section 8: Unlisted Rails: Procedures for Documentation

Attempt to establish the rail's crashworthiness through investigation of the resources listed in the Preface of this Rail Guide. Keep in mind that some of the listed resources contain errors or omissions. See the Preface for more information.

If the rail appears in multiple resources but is assigned different specification information in each, use published crash tests and FHWA-authored documents as the primary and most valid resources to determine specification, Test Level, and any equivalencies. Where applicable, retain barrier names associated with the original crash test or FHWA listing.

Many rails that do not already appear in this Guide will not have crash test data. A new page should be created whether crash tests are found or not, so that future users of the Guide will not have to re-create the rail information.

Create a new rail page using the format established by this Rail Guide. Illustrate the rail using a drawing or photograph as an example. Include major dimensions for easy reference. For each of the listed characteristics of the rail (right side panel of new rail page), use the following guidance:

- List only the specification known to be referenced in the crash test report for the rail. If none can be found, show as "Test Specification: unknown/not tested". If no crash test data is available, review the rail's characteristics against AASHTO Specifications for Highway Bridges 2.7.1 "Vehicular Railings".
- If test specification equivalencies are listed, these must be supported by documentation such as the 1997 FHWA Memo or by written assessment by an accredited testing agency (e.g. UNL/MwRSF, TTI, etc.).
- The "B.RH.01" or "B.RH.02" code that is assigned to a rail must conform to the AASHTO Subsection 2.3, "Roadside Hardware" bridge rail coding requirement. Consult the selection matrix in that document to establish an appropriate code. Review with Iowa DOT Bridges and Structures Methods Unit or Design Bureau Methods personnel as appropriate.
- Include any pertinent notes regarding how the rail is used, or if use is known to be conditional in any way.
- If possible, list one or more known locations of the rail on the new rail page.
- List the network folder location for supporting information pertaining to the rail. Store in a new folder at the network location indicated on existing rail pages in the Rail Guide. Use a similar naming convention for new rail folders to maintain consistency and to uniquely describe any new rails. Be careful not to use a rail name already used in the Guide.
- Publish an updated PDF of the Rail Guide and make available to users. Retain superseded versions in an archive for reference.

## Section 9: Barrier Rail Attachments

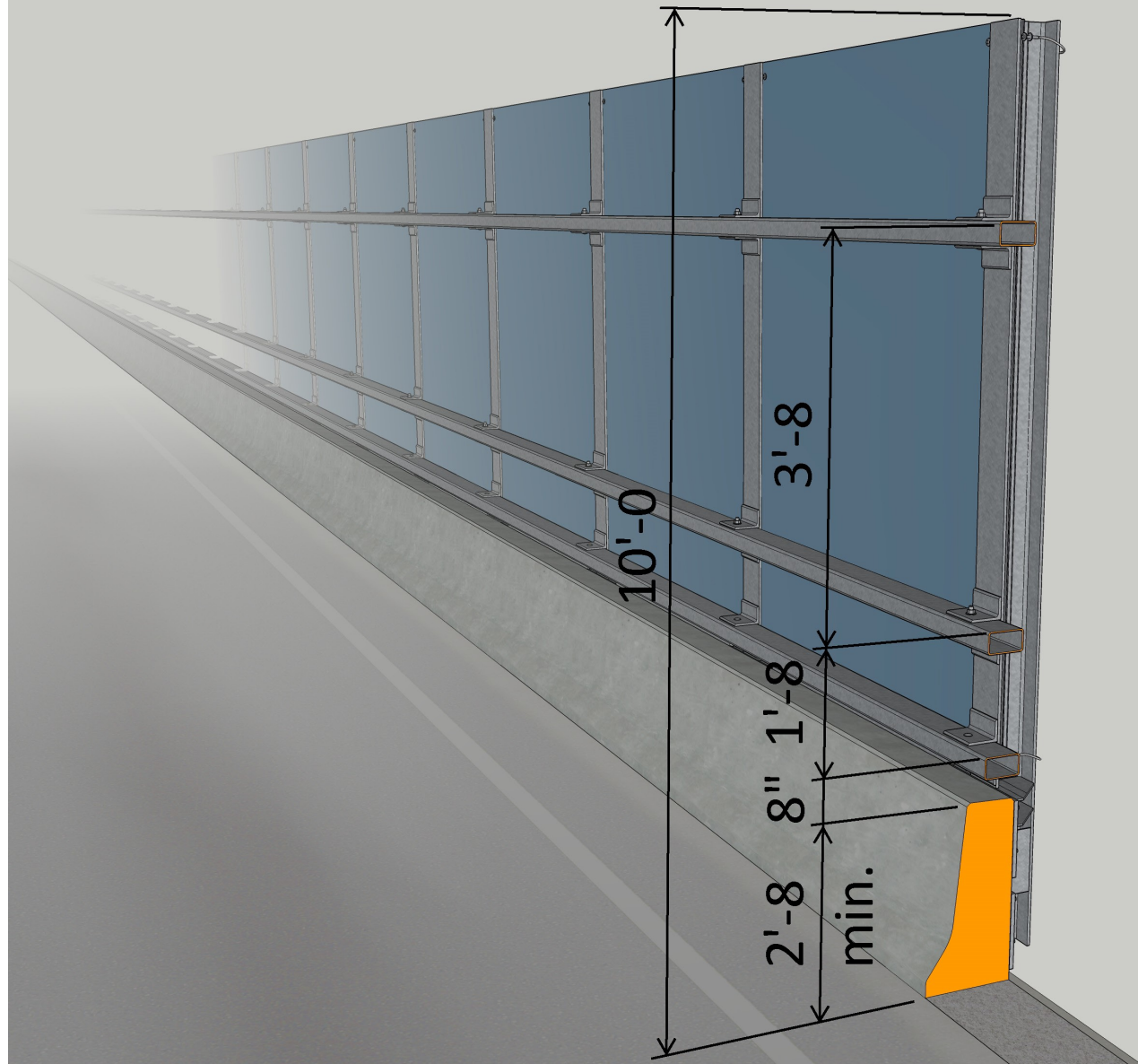

### Acrylite Soundstop TL-4 Noise Barrier

- NCHRP 350, TL-4
- Current MASH equivalency: unknown, but a revised version of the illustrated system has been crash tested to TL-4 under MASH
- AASHTO B.RH.01 Code (if needed): 3504
- Notes: system shown is only approved for use in Iowa when mounted to a 2'-10 minimum height safety shape rail; system is proprietary and was manufactured by Armtec/Evonik Cyro LLC for the single existing installation in Iowa; new MASH system manufacturer is Durisol
- FHWA Letter: HSA-10/B-136
- Example location: WB I-380/US 218/US 20 over McCoy RD, Evansdale, Black Hawk Co. Design 1115
- W:\Highway\Bridge\MethodsSection\Barriers\Rail Guide\2\_Other Pre-MASH Rails Used by DOT\Acrylite Soundstop on Safety Shape

## Section 9: Barrier Rail Attachments

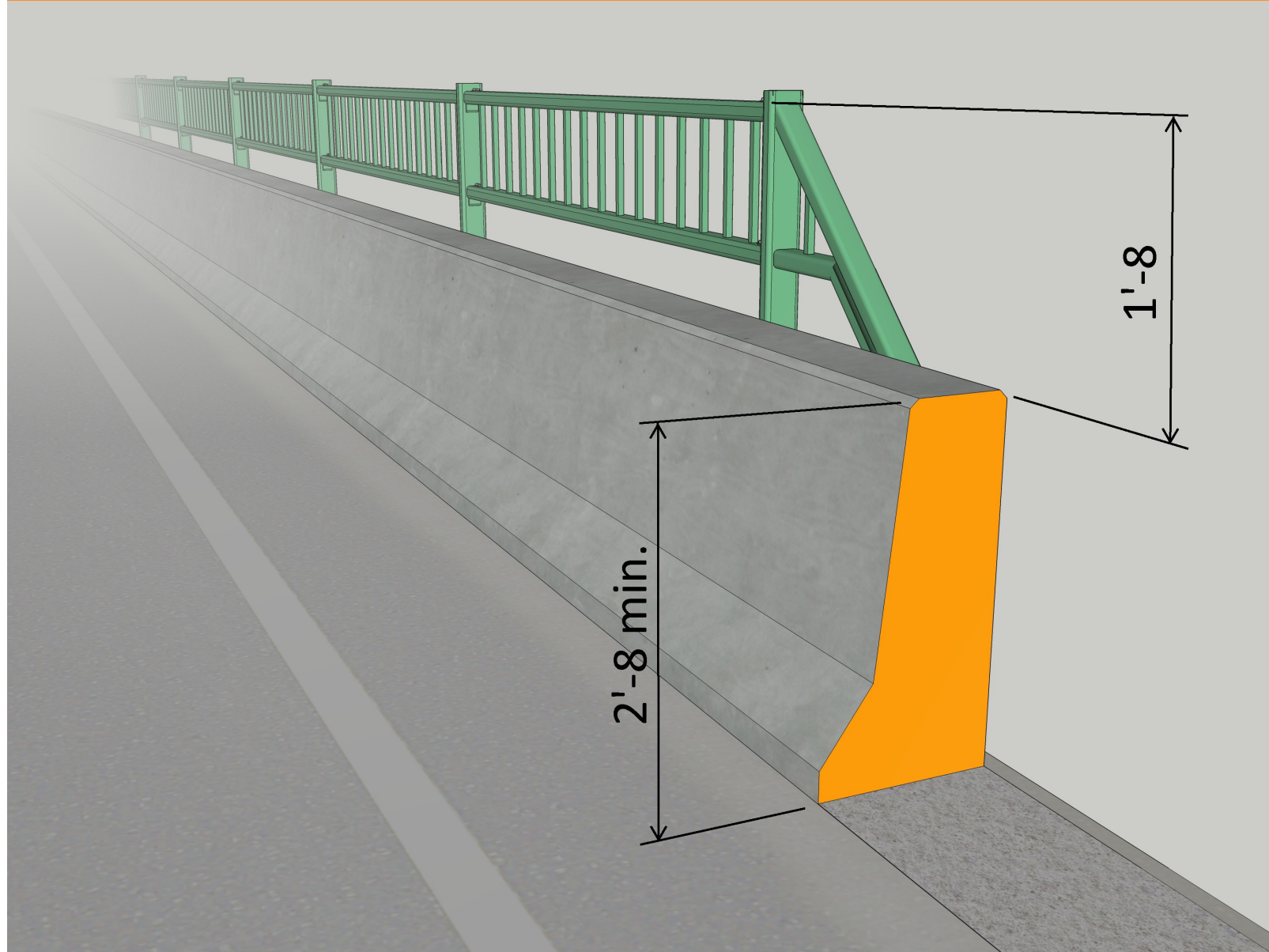

### MnDOT TL-4 Back-Mounted Bicycle Railing

- NCHRP 350, TL-4
- Current MASH equivalency: unknown, but a revised version of the illustrated system has been crash tested to TL-3 under MASH
- AASHTO B.RH.01 Code (if needed): 3504
- Notes: system shown is only approved for use in Iowa when mounted to a 2'-8 minimum height safety shape rail; system includes cable retention system inside horizontal tubes; cost \$220/LF (2021)
- Crash test report: TRP-03-74-98
- Example location: Pole Line RD over stream, Decorah, Winneshiek Co. (built 2021)
- W:\Highway\Bridge\MethodsSection\Barriers\Rail Guide\2\_Other Pre-MASH Rails Used by DOT\MnDOT Bicycle Railing

# Section 9: Barrier Rail Attachments

Variations:

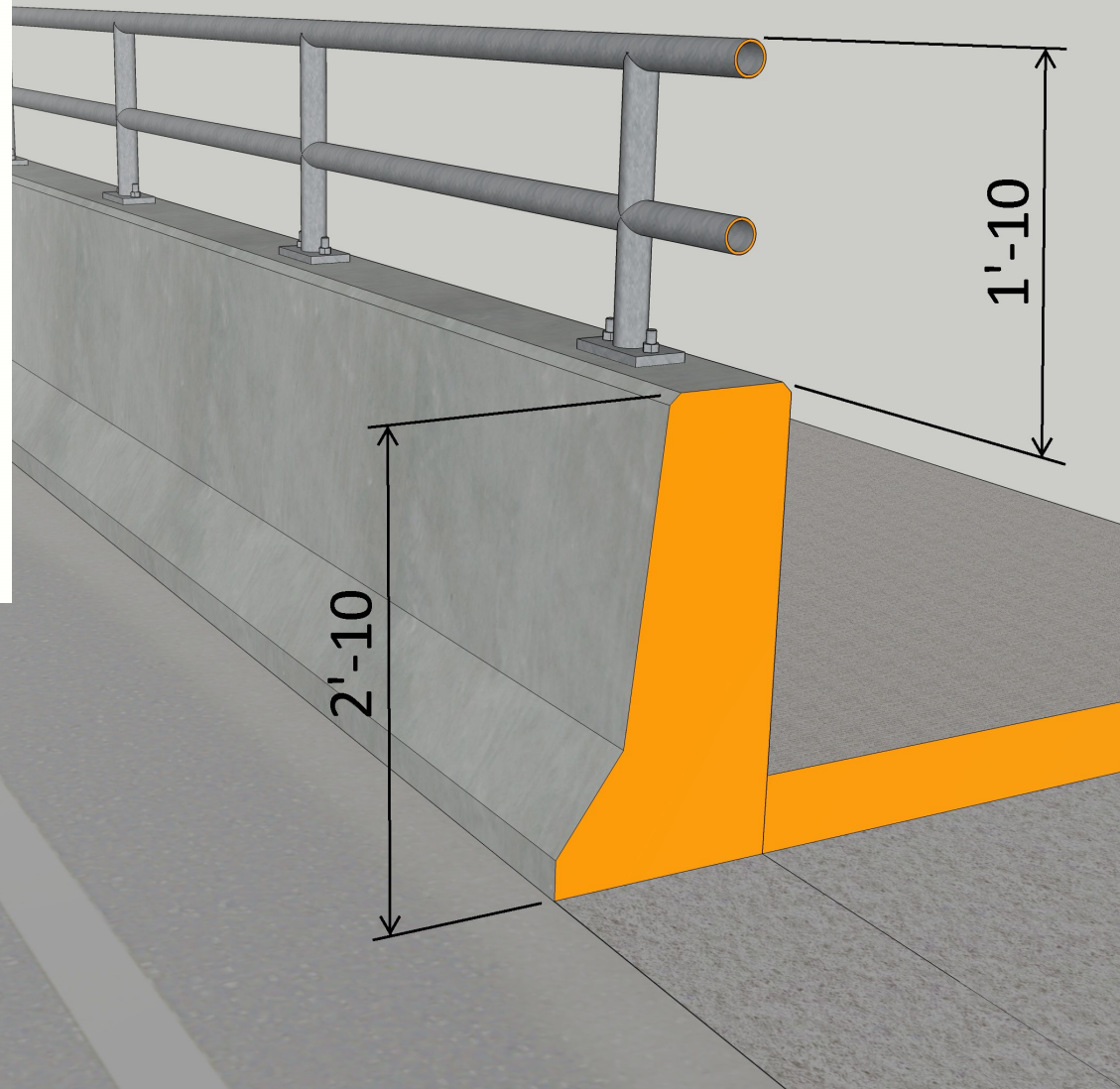
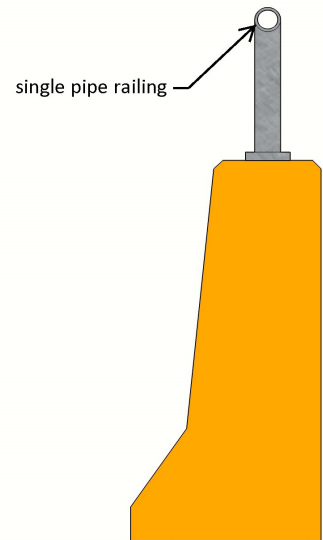

## Safety Shape with Combo Rail

- Test spec: unknown/not tested
- AASHTO B.RH.01 Code: (NA)
- Notes: known as Standard 1028 and 1029 in Iowa, this design has been used extensively as a separation barrier on low-speed roadway bridges; Task Force 13 lists a similar Georgia design as NCHRP 350 TL-4 compliant, but no supporting crash test research can be found; UNL/MwRSF also could not locate test data for a barrier with this type of attachment; no longer used on State bridge projects (as of 2023), but can be used at the Local Systems level on low speed roadways
- W:\Highway\Bridge\MethodsSection\Barriers\Rail Guide\2\_Other Pre-MASH Rails Used by DOT\Safety Shape with Combo Rail

# Section 9: Barrier Rail Attachments

(traffic on left side typ.; examples shown are not all-inclusive for this type)

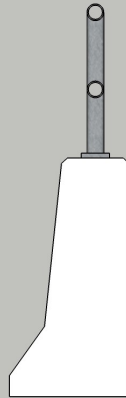

Multi-pipe railing on Standard 1028/1029 separator (see "Safety Shape with Combo Rail")

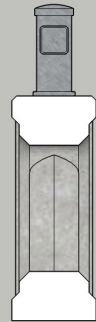

Texas T411 with bike railing, IA 1 over Ralston Creek, Iowa City and IA 150 over Wapsipinicon River, Independence IA

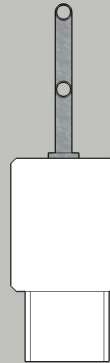

Multi-pipe railing on Iowa Beam and Post, Douglas Ave over Fourmile Cr, Des Moines IA

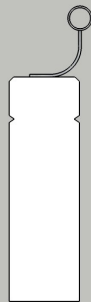

US 169 over E. Fork of Des Moines River, Algona IA



IA 1 over Des Moines River, Keosauqua, IA (sidewalk side of bridge)



6th Street and Grand Avenue bridges over Iowa Creek, Ames IA

## Top-Mounted Bicycle Railing Attachments

- Test spec: not tested
- Current MASH equivalency: unknown
- AASHTO B.RH.01 Code: (NA)
- Notes: many attachments of the type shown were developed prior to AASHTO RDG guidance in 2011 which recommended the barrier's Zone of Intrusion (ZOI) be kept clear of attachments when practical, and prior to research studies on vehicle intrusion above the barrier and how such attachments could affect rail performance (MwRSF Report TRP-03-98-03, 2003); top-mounting of bike rails can increase risks of vehicle passenger head contact as well as snowplow blade interaction
- W:\Highway\Bridge\MethodsSection\Barriers\Rail Guide\2\_Other Pre-MASH Rails Used by DOT\Bicycle Railing Attachments\Top-Mounted Bike Rail

# Section 9: Barrier Rail Attachments

(traffic on left side typ.; examples shown are not all-inclusive for this type)

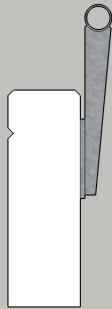

US18/US 71 over Little Sioux River, Spencer IA

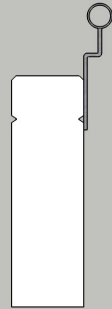

MLK Parkway over Des Moines River, Des Moines IA

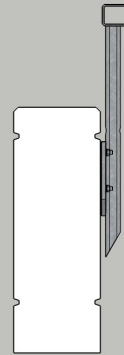

US 52 over Mill Creek and RR, Bellevue IA

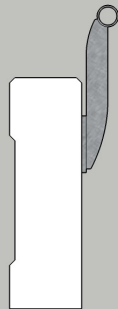

IA 1 over Des Moines River, Keosauqua IA (trail side of bridge)

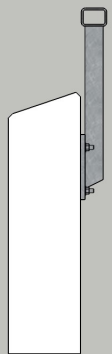

50th Street over I-235, West Des Moines IA

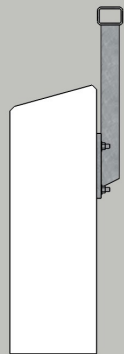

Co Rd S14 over US 30, Nevada IA ("BMBR" separation rail system)

## Back-Mounted Bicycle Railing Attachments

- Test spec: not tested
- Current MASH equivalency: unknown
- AASHTO B.RH.01 Code: (NA)
- Notes: attachments of this type were developed to reduce the potential for passenger head ejection contact with top-mounted bike rails, and to reduce chances of snowplow blade contact; extra sidewalk width is required beyond the barrier footprint to accommodate back-mounted bike rails; check all new designs against criteria established in NCHRP Report 1018 to keep bike rails out of expected ZOI for the barrier height and roadway conditions (posted speed, presence of trucks, etc.)
- W:\Highway\Bridge\MethodsSection\Barriers\Rail Guide\2\_Other Pre-MASH Rails Used by DOT\Bicycle Railing Attachments\Back-Mounted Bike Rail



# Section 9: Barrier Rail Attachments

Acceptable Variations:

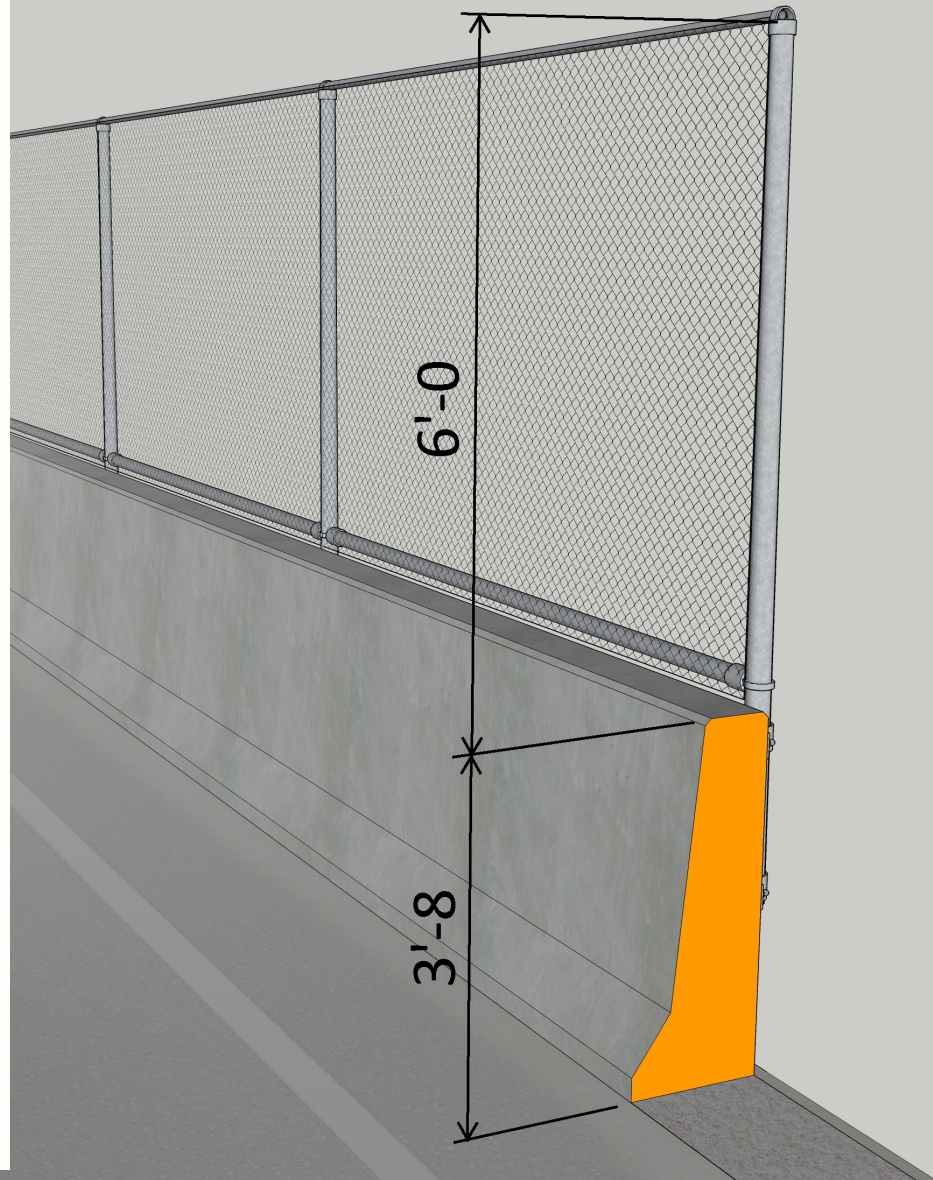
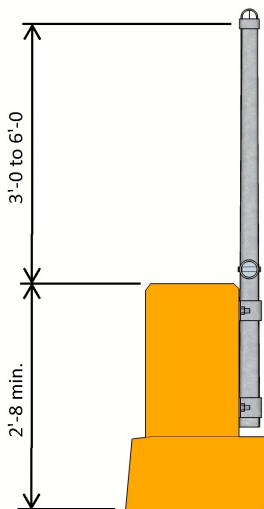
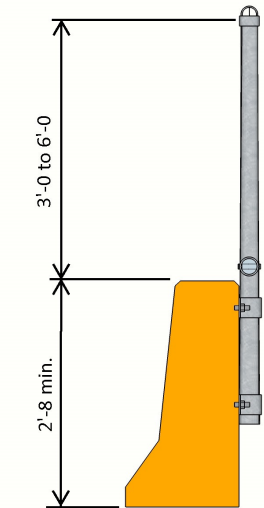

## Back-Mounted Fence on Rail (Type 1)

- 1989 Guide Specification for Bridge Railings, PL-2 (NCHRP 350 TL-4)
- Current MASH equivalency: unknown
- AASHTO B.RH.01 Code (if needed): 892
- Notes: use of back-mounted fence in low-speed applications was approved by the Iowa DOT MASH Committee on 08/02/2023; installations must comply with setback distance guidelines found in NCHRP Report 1018 for barrier height and conditions
- Crash test report: FHWA-RD-96-032
- Locations: US 63 over CC&PRR, Waterloo, Black Hawk Co. Design 915; IA 117 over US 163, Prairie City, Jasper Co.; 27th Ave over I-380, Cedar Rapids, Linn Co. Design 324
- W:\Highway\Bridge\MethodsSection\Barriers\Rail Guide\2\_Other Pre-MASH Rails Used by DOT\Barrier-Mounted Fence\Type 1

## Section 9: Barrier Rail Attachments

### Back-Mounted Fence on Rail (Type 2)

- Test spec: not tested
- Current MASH equivalency: unknown
- AASHTO B.RH.01 Code: (NA)
- Notes: fence is for decorative purposes and is mounted to traffic barrier adjacent to vehicular traffic only, not pedestrians; setback distance from traffic face complies with guidance found in NCHRP Report 1018 for the barrier's height and roadway conditions (posted speed, presence of trucks, etc.)
- Example location: 1st Street NB and SB over I-80, Coralville, Johnson Co. Designs 524 and 624
- W:\Highway\Bridge\MethodsSection\Barriers\Rail Guide\2\_Other Pre-MASH Rails Used by DOT\Barrier-Mounted Fence\Type 2

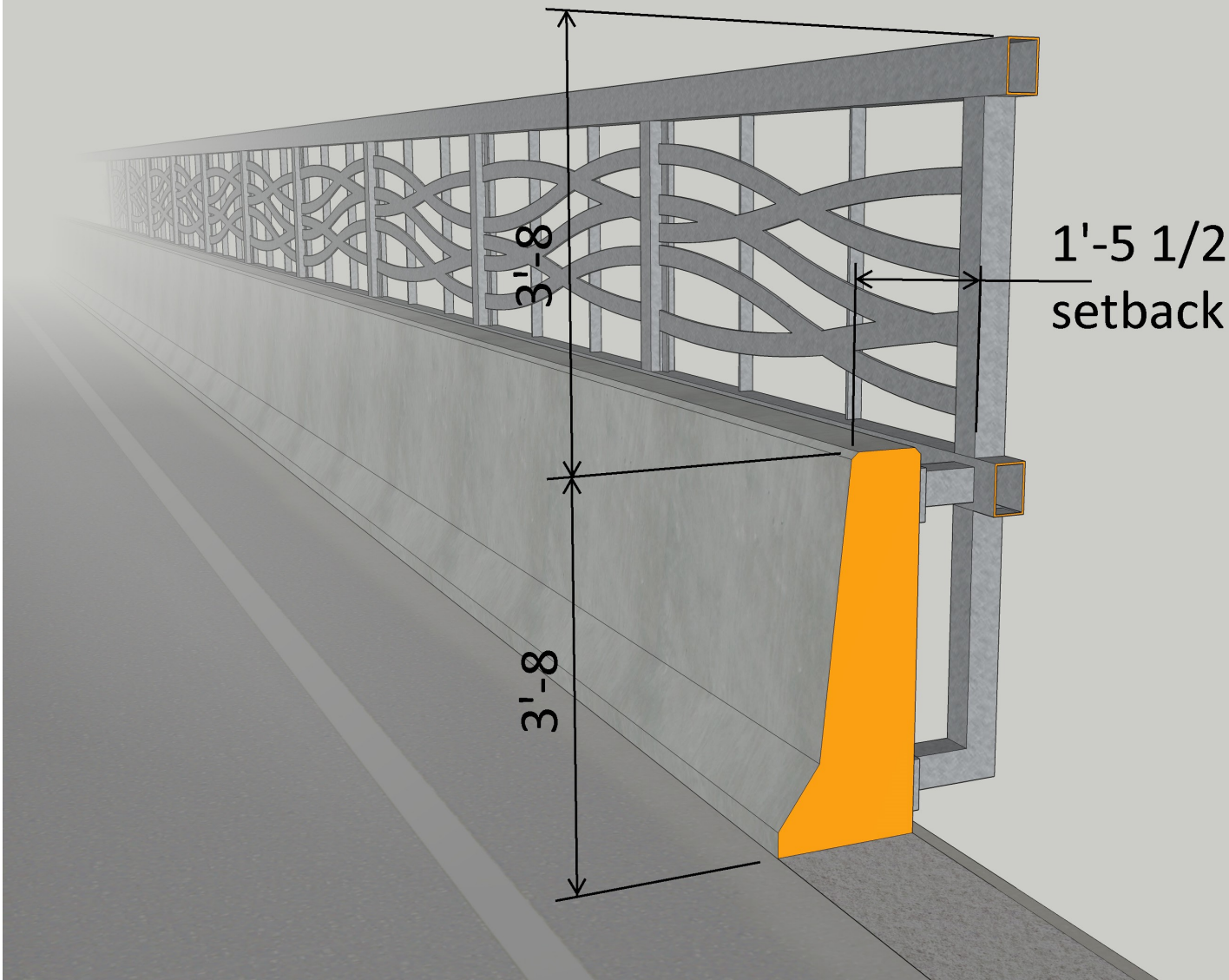

# Section 10: Barrier End Sections

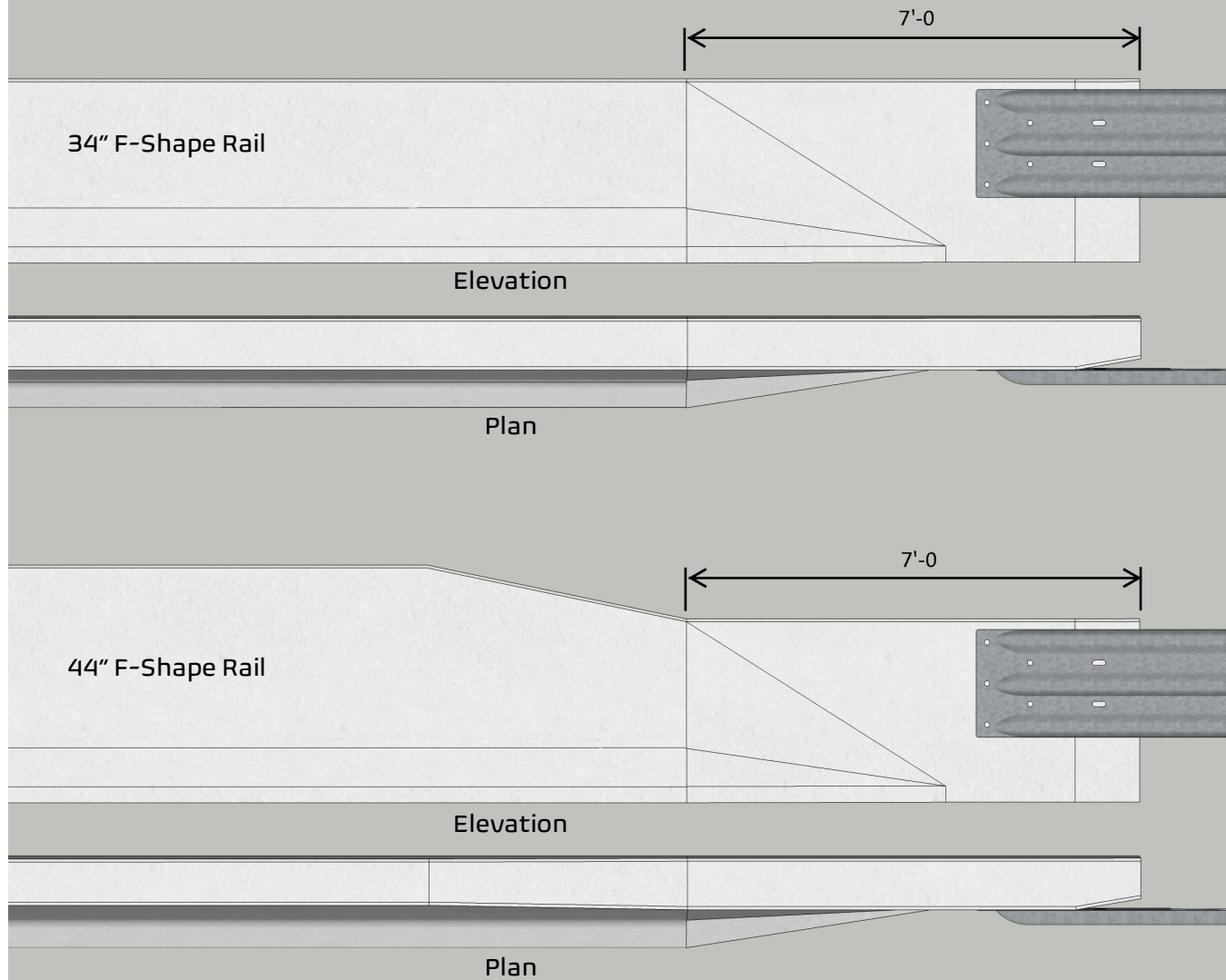

## F-Shape Barrier End for Guardrail

- NCHRP 350, TL-3
- Current MASH equivalency: unknown
- AASHTO B.RH.01 Code (if needed): 3503
- Notes: known as Standard 1017/1017S in Iowa
- Crash test reports: FHWA/TX-04/4564-1, TRP-03-069-98, TRP-03-175-06
- W:\Highway\Bridge\MethodsSection\Barriers\Rail Guide\7\_Barrier End Sections

# Section 10: Barrier End Sections

38" Single Slope Rail

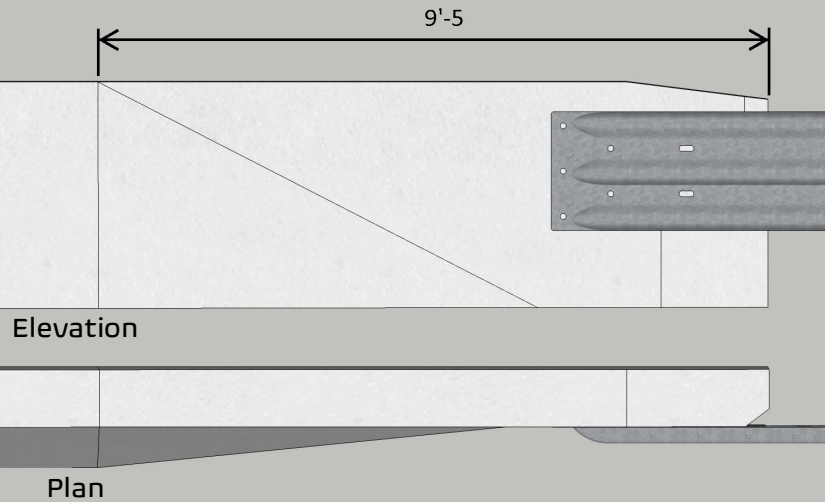

44" Single Slope Rail

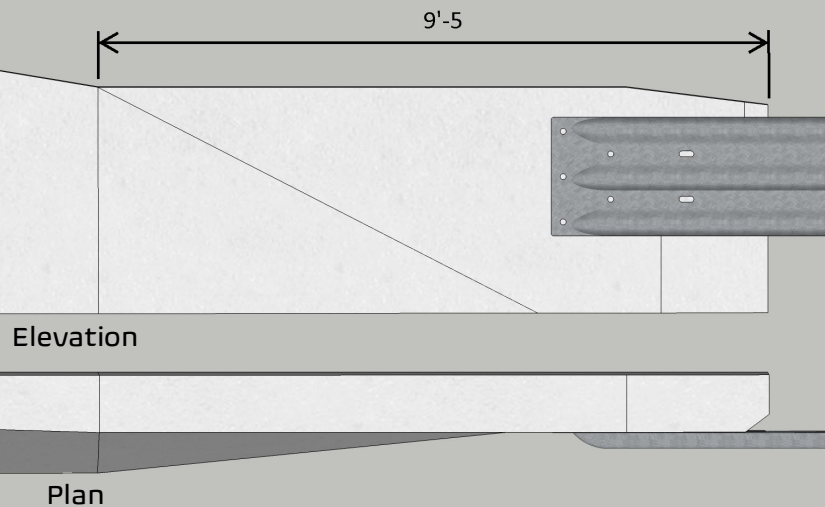

## Single Slope Barrier End for Guardrail

- MASH 2016, TL-3
- AASHTO B.RH.01 Code (if needed): M163
- Notes: adopted for new single slope standard rails for projects beginning in 2024
- Crash test report: TRP-03-369-20
- W:\Highway\Bridge\MethodsSection\Barriers\Rail Guide\7\_Barrier End Sections

# Section 10: Barrier End Sections

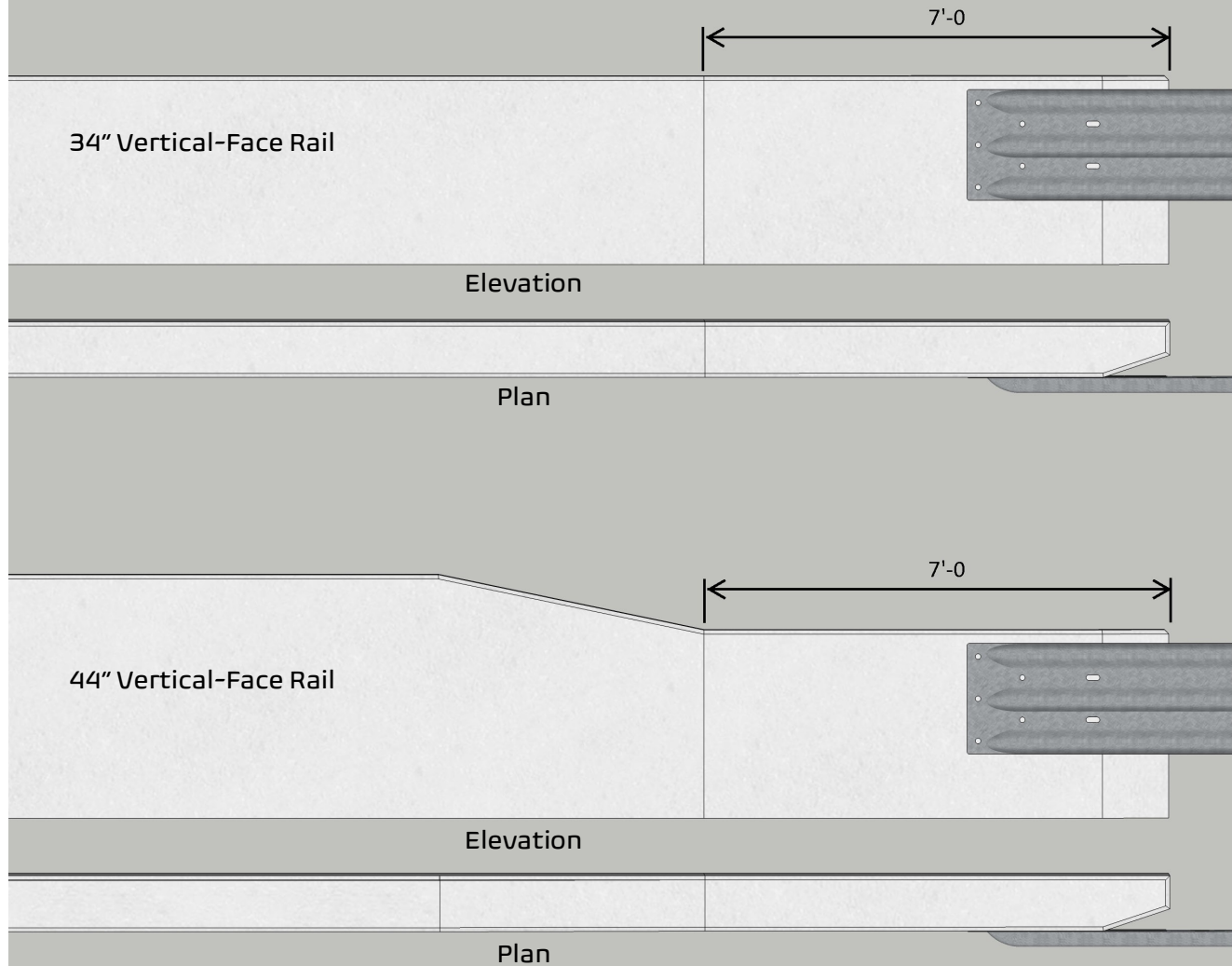

## Vertical-Face Barrier End for Guardrail

- 1989 Guide Specifications for Bridge Railings, PL-2
- NCHRP 350 equivalent: TL-4
- Current MASH equivalency: unknown
- AASHTO B.RH.01 Code (if needed): 892
- Notes: the guardrail attachment as tested was not set back from the gutter line as it is with safety shapes and single slopes; there is no reason to create setback from the gutter line to the face of guardrail unless minimum roadway width is compromised; any change to the tested configuration may void the crashworthiness of the system
- Crash test report: FHWA-RD-93-058
- Example locations: E Ave over IA 100, Cedar Rapids, Linn Co. Design No. 915
- W:\Highway\Bridge\MethodsSection\Barriers\Rail Guide\7\_Barrier End Sections

# Section 10: Barrier End Sections

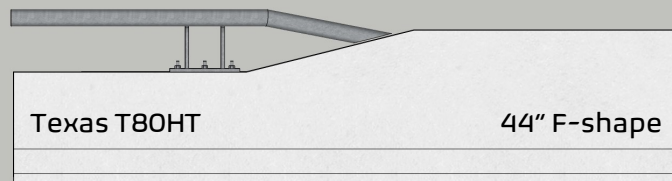

T80HT rail end example where continuous approach barrier is present; includes a modification to the TxDOT standard steel rail end detail; see I-74 over the Mississippi River, Bettendorf IA, Scott Co. Designs 1417, 1519

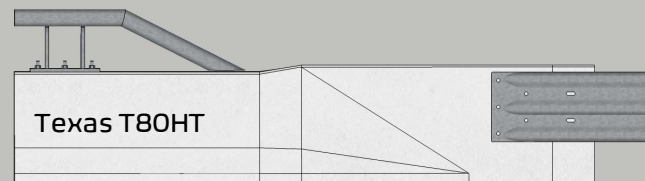

T80HT rail end example where approach guard-rail transition (AGT) is required; includes TxDOT standard detail for steel rail termination; see I-80 over Missouri River, Pottawattamie Co. Design 408



PennDOT PA rail end example where approach guardrail transition (AGT) is present; special steel AGT connection details are required; configuration and changes to PennDOT standard details were favorably reviewed by MwRSF; see IA 9 over the Mississippi River, Lansing, Allamakee Co. Design 124

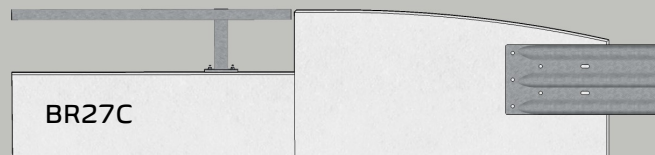

BR27C rail end example where approach guard-rail transition (AGT) is present; see US 61 over Flint Creek, West Burlington IA, Des Moines Co. Design 117

## Steel-on-Concrete Barrier Ends

- Test spec: unknown/not tested
- Current MASH equivalency: unknown
- AASHTO B.RH.01 Code: (NA)
- Notes: also see Steel-on-Concrete Barrier Sloped End Transitions for low speed conditions
- W:\Highway\Bridge\MethodsSection\Barriers\Rail Guide\7\_Barrier End Sections

# Section 10: Barrier End Sections

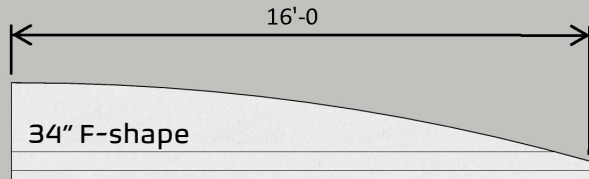

Design Bureau Standard Road Plan BA-108 sloped end transition (SET) typically used on approach pavement

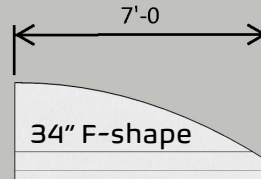

V8i bridge Standard 1019 series sloped end transition to fit 7'-0 abutment wing; BA-108 SET on approach pavement is preferred over this design

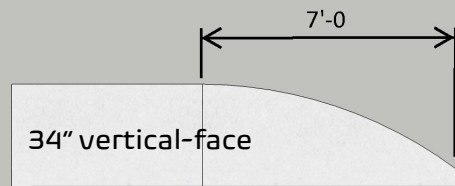

V8i bridge Standard 1019-based design for vertical-face barrier on 7'-0 abutment wing; BA-108 SET on approach pavement is preferred over this design

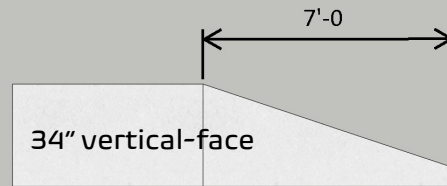

Custom transition for vertical-face barrier on 7'-0 abutment wing (used on I-235); BA-108 SET on approach pavement is preferred over this design

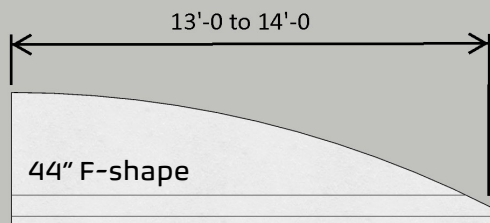

Custom transition for tall F-shape (example at Linn Co. Designs 321/421 and 425/525); BA-108 SET on approach pavement is preferred over this design

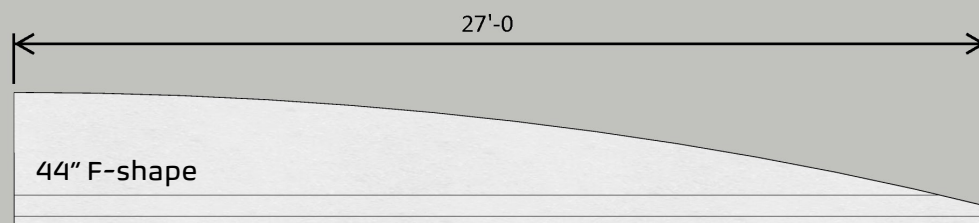

Custom transition for tall F-shape (example at Johnson Co. Design 1020); mount on approach pavement when 44-in barrier extends to the end of abutment wing (unlike when guardrail is attached to reduced-height end section, with barrier height transition on bridge)

## Concrete Barrier Sloped End Transitions (p.1 of 2)

- Test spec: unknown/not tested
- Current MASH equivalency: unknown
- AASHTO B.RH.01 Code: (NA)
- Notes: sloped end transitions (SETs) are for use in low speed conditions only, generally 30 MPH and lower posted speed
- In Service Performance Evaluation (ISPE) of some Iowa concrete SETs: TRP-03-421-20
- Related research: TRP-03-109-02, TRP-03-127-03, TRP-03-408-20
- W:\Highway\Bridge\MethodsSection\Barriers\Rail Guide\7\_Barrier End Sections

# Section 10: Barrier End Sections

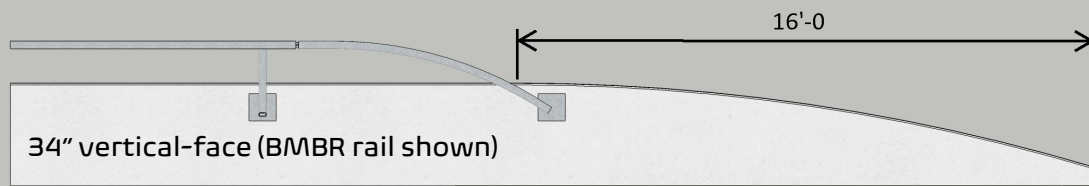

34" vertical-face (BMBR rail shown)

Sloped end transition configured to match profile of BA-108 SET but with vertical face in lieu of safety shape or single slope; mount to approach pavement



IBBR Separation Rail (MASH)

IBBR separation rail includes a long straight tapered end section based on crash tested transitions; see TRP-03-408-20 for more information

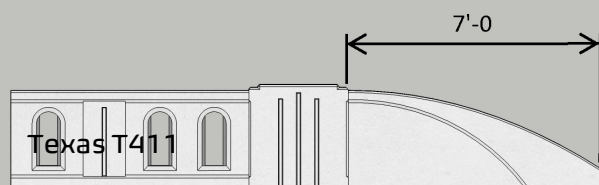

Texas T411 rail with sloped transition sized to fit V8i standard 7'-0" abutment wing; longer transition matching BA-108 is preferred over this design



Texas T411 with sloped end transition configured to match profile of BA-108 SET but with vertical face in lieu of safety shape or single slope; mount to approach pavement; shallow traffic face rustication (0.75 in) is acceptable

## Concrete Barrier Sloped End Transitions (p.2 of 2)

- Test spec: unknown/not tested
- Current MASH equivalency: unknown
- AASHTO B.RH.01 Code: (NA)
- Notes: sloped end transitions (SETs) are for use in low speed conditions only, generally 30 MPH and lower posted speed
- In Service Performance Evaluation (ISPE) of some Iowa concrete SETs: TRP-03-421-20
- Related research: TRP-03-109-02, TRP-03-127-03, TRP-03-408-20
- W:\Highway\Bridge\MethodsSection\Barriers\Rail Guide\7\_Barrier End Sections



# Section 10: Barrier End Sections

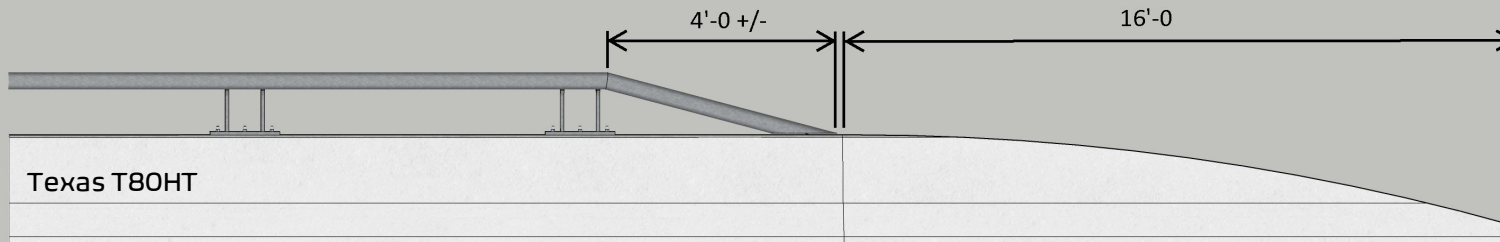

Texas T80HT

Texas T80HT sloped end transition configured to match profile of BA-108 SET but with safety shape in lieu of single slope; mount to approach pavement; example shown is the trail separation barrier at I-35 over 1st Street DDI, Ankeny, Polk Co., IM-NHS-035-4(196)92-03-77 (grading)

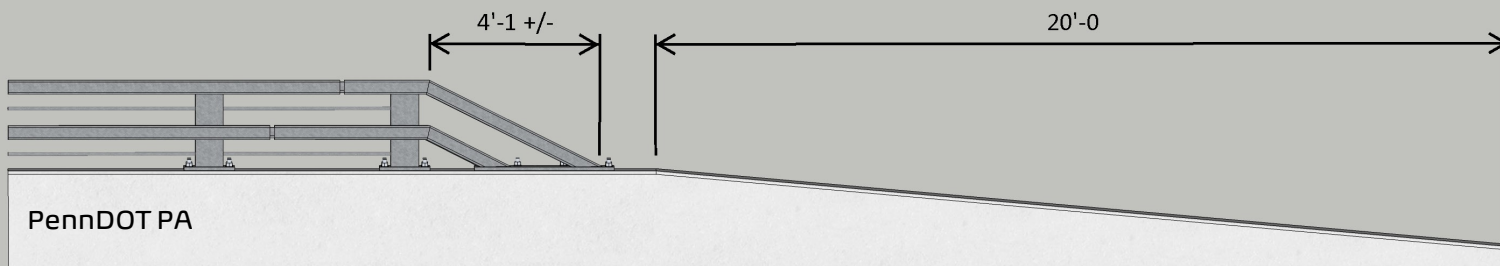

PennDOT PA

PennDOT PA sloped end transition configured to match profile of crash tested transitions described in TRP-03-408-20; example shown is barrier termination used at IA 9 over the Mississippi River at Lansing, Allamakee County Design No.124, STP-009-9(82)-2C-03 (grading and pavement); steel rail terminus reviewed by MwRSF

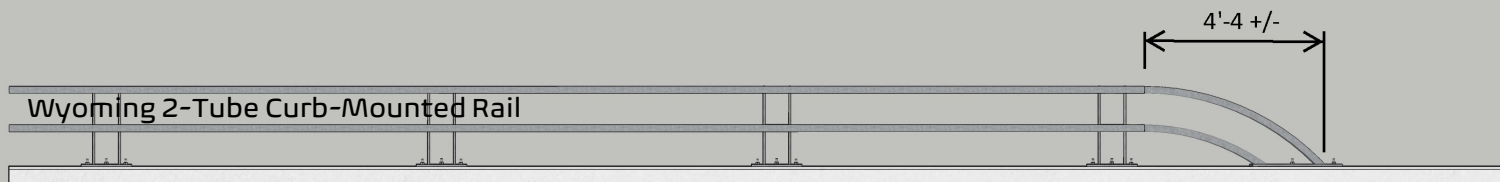

Wyoming 2-Tube Curb-Mounted Rail

Wyoming 2-Tube steel rail transition in accordance with WY standard plans; basic rail system is approved at NCHRP 350 TL-3, but there is no evidence that the steel railing terminus shown has been crash tested; example shown is barrier termination used at Grand Ave over MLK Parkway, Des Moines (city bridge project)

## Steel-on-Concrete Barrier Sloped End Transitions

- Test spec: unknown/not tested
- Current MASH equivalency: unknown
- AASHTO B.RH.01 Code: (NA)
- Notes: sloped end transitions (SETs) are for use in low speed conditions only, generally 30 MPH and lower posted speed
- W:\Highway\Bridge\MethodsSection\Barriers\Rail Guide\7\_Barrier End Sections

# Section 11: Barrier Traffic Face Texture Guidelines

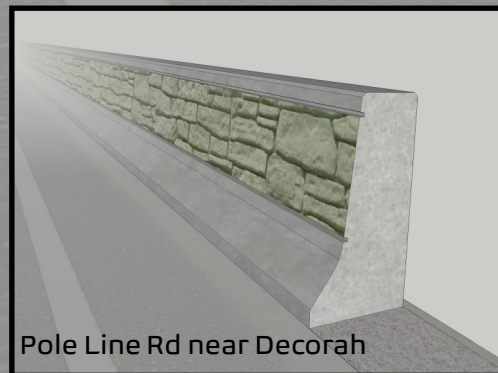
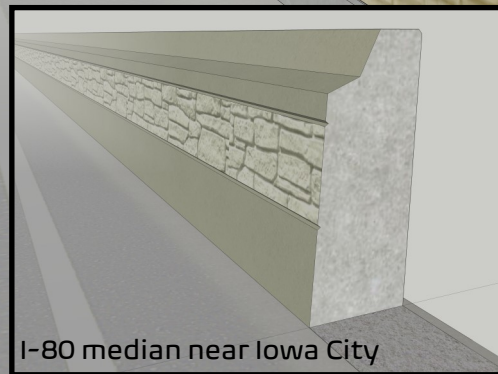
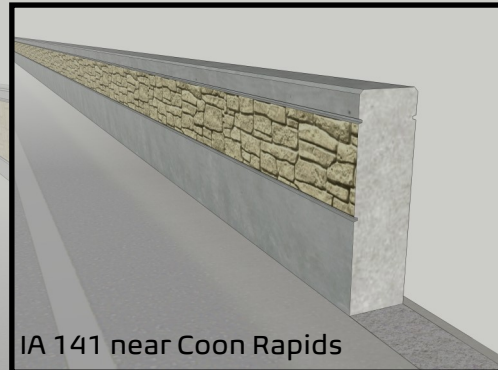

## Concrete Form Liner Texture

- NCHRP 350 TL-3
- Current MASH equivalency: unknown
- AASHTO B.RH.01 Code (if needed): 3503
- Notes: texture characteristics must be in conformance with guidelines in the listed research documents
- Applicable research: FHWA/CA/TL-2002/03 California Department of Transportation, "Crash Testing of Various Textured Barriers", 2002 and FHWA Letter HSA-10/B110; NCHRP Report 554, "Aesthetic Concrete Barrier Design", 2006
- Example locations: US 52 over Mill Creek and RR, Bellevue, Jackson Co. Design 108; IA 141 over Middle Raccoon River, Coon Rapids, Guthrie Co. Design 314
- W:\Highway\Bridge\MethodsSection\Barriers\Rail Guide\Surface-Textured Conc Rails

# Section 11: Barrier Traffic Face Texture Guidelines

## Concrete Rustication

- NCHRP 350 TL-3
- Current MASH equivalency: unknown
- AASHTO B.RH.01 Code (if needed): 3503
- Notes: rustication characteristics must be in conformance with guidelines in the listed research documents
- Applicable research: NCHRP Report 554, "Aesthetic Concrete Barrier Design", 2006
- Example locations: IA 1 over Des Moines River, Keosauqua, Van Buren Co. Design 105; US 169 over E. Fork Des Moines River, Algona, Kossuth Co. Design 107; Co. Rd. S14 over US 30, Nevada, Story Co. Design 123
- W:\Highway\Bridge\MethodsSection\Barriers\Rail Guide\Surface-Textured Conc Rails

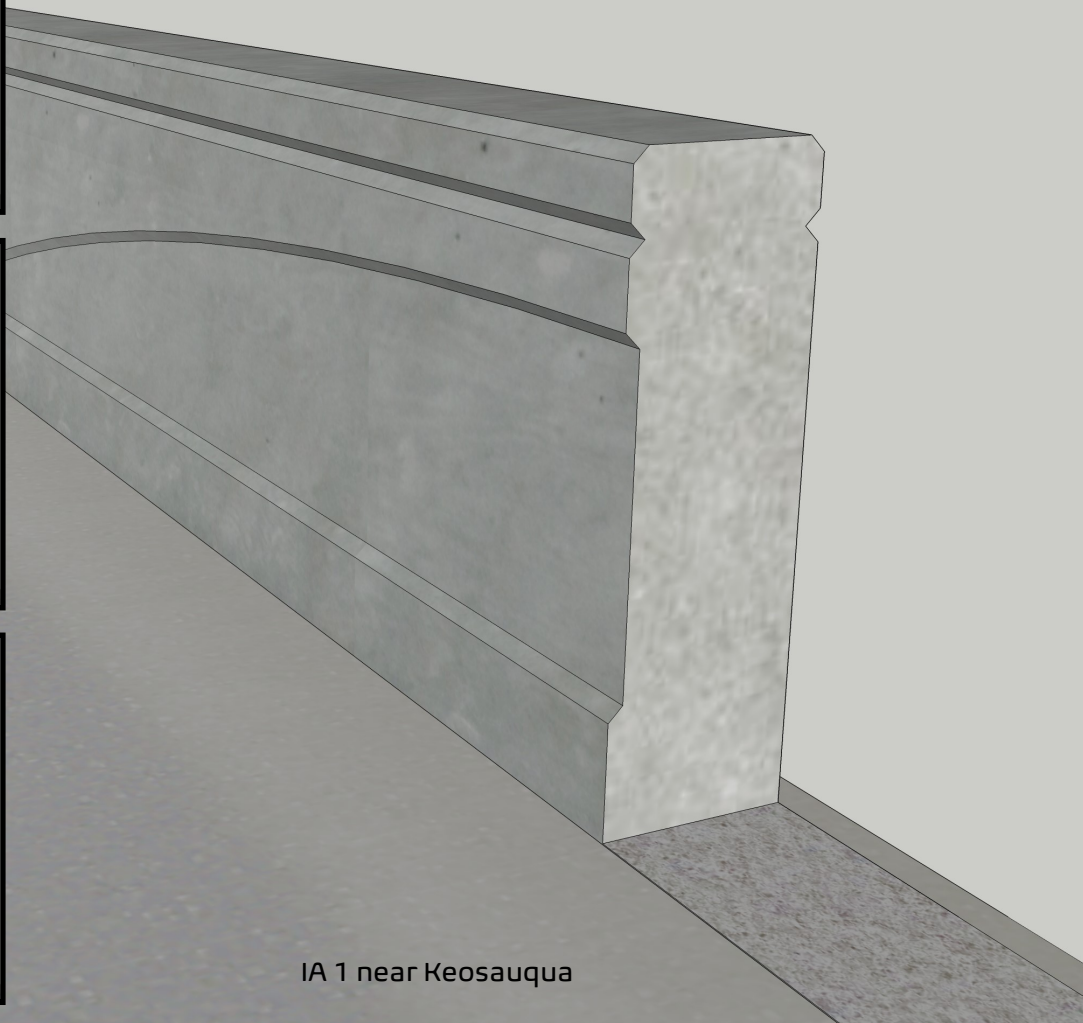
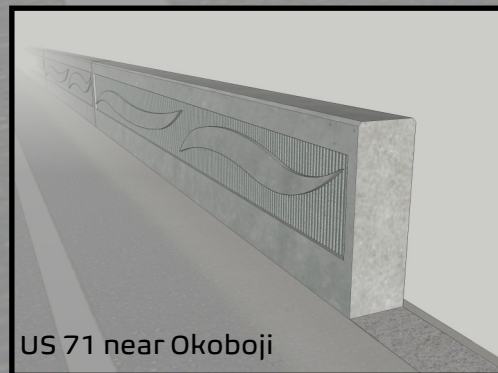
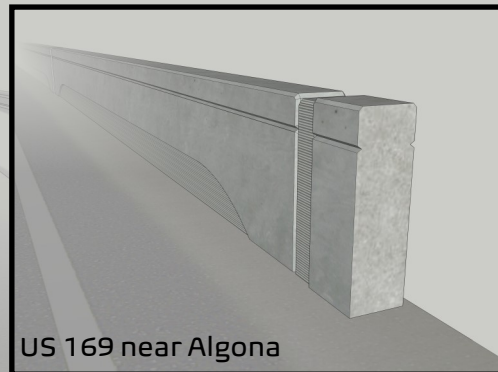

# Section 11: Barrier Traffic Face Texture Guidelines

## Integral Thin Veneer Brick

- NCHRP 350 TL-3
- Current MASH equivalency: unknown
- AASHTO B.RH.01 Code (if needed): 3503
- Notes: integral thin veneer brick is in conformance with guidelines in the listed research documents; brick thickness (nominal 0.625 in) may be considered part of the clear concrete cover over near reinforcing
- Applicable research: FHWA/CA/TL-2002/03 California Department of Transportation, "Crash Testing of Various Textured Barriers", 2002 and FHWA Letter HSA-10/B110; NCHRP Report 554, "Aesthetic Concrete Barrier Design", 2006
- Example locations: US 65 over Iowa River, Iowa Falls, Hardin Co. Design 110; E Ave over IA 100, Cedar Rapids, Linn Co. Des. 915
- W:\Highway\Bridge\MethodsSection\Barriers\Rail Guide\Surface-Textured Conc Rails



E Avenue near Cedar Rapids

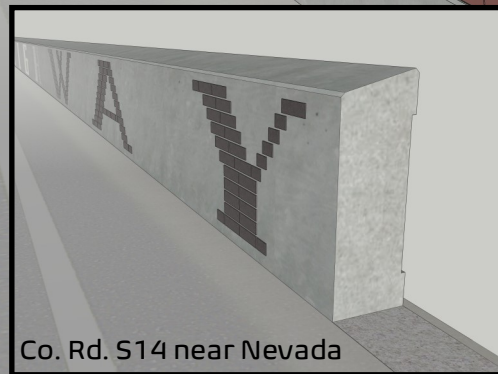

Co. Rd. S14 near Nevada



IA 3 in Waverly

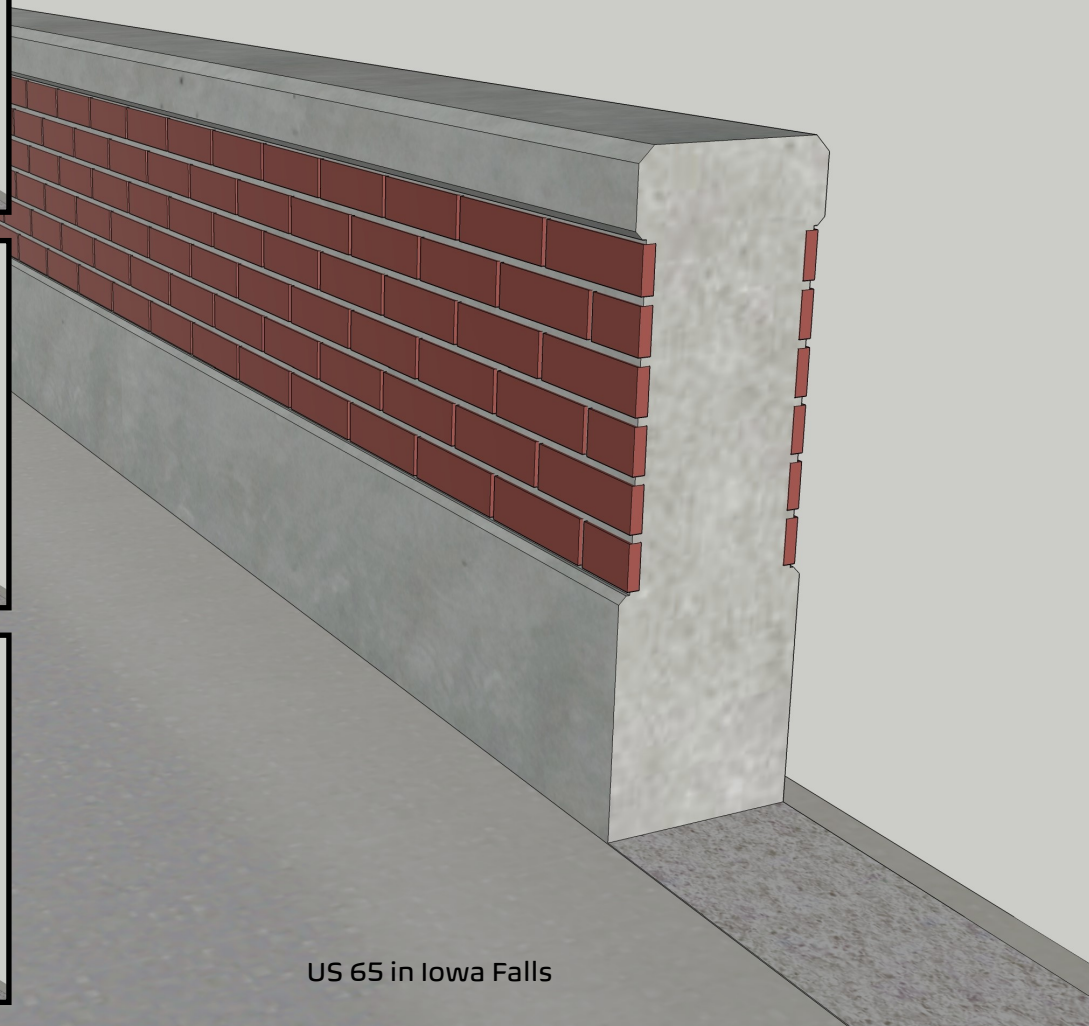

US 65 in Iowa Falls